

INSTALLATION INSTRUCTIONS

Thank you for choosing Ambassador Marine.

Your new Ambassador Marine faucet, sprayer, shower or accessory will give you years of trouble-free performance. Please read these instructions carefully before installing your new item. If you have any additional questions about the installation of this product, please feel free to contact one of our friendly customer service representatives at 800.270.4262.

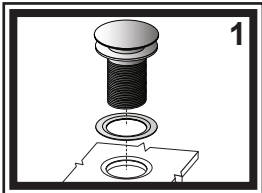

1) Set the touch body assembly with the thin gasket in the drain hole in the sink. NOTE: The thin gasket is supplied for your convenience, however, we recommend using plumber's putty (not included) instead of the gasket. Do not use both the gasket and plumber's putty.

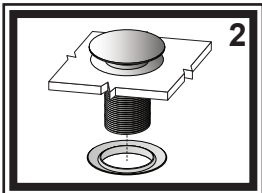

2) From under the sink, slide the thick rubber gasket up onto the threaded touch body assembly and snug against the bottom of the sink.

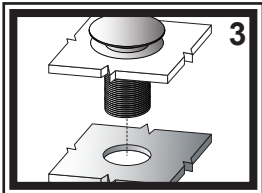

3) Set the sink with the drain assembly and thick rubber gasket into the counter top with the drain going through the hole in the counter top. OPTIONAL- If you are using the optional Mounting Base ring, slide it onto the threaded touch body assembly between the gasket and the counter top.

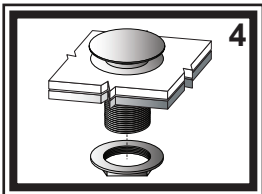

4) Screw the lock nut onto the touch body assembly, but do not tighten completely.

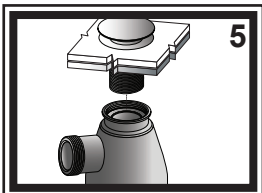

5) Ensure the trap cup is tightly screwed onto the trap body with the rubber gaskets inside the connection. Screw the trap body with the rubber gasket installed onto the threaded touch body securely. Make sure the side port of the trap body is pointed in the desired direction for connecting the waste line, rotate complete assembly if needed. Tighten lock nut, securing the sink and drain assembly to the counter top.

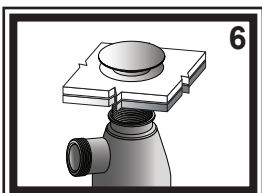

6) Screw 1 1/4" drain pipe or adapter (not included) onto the Body. Use Teflon tape (not included) on the threads to prevent leaks.

Parts

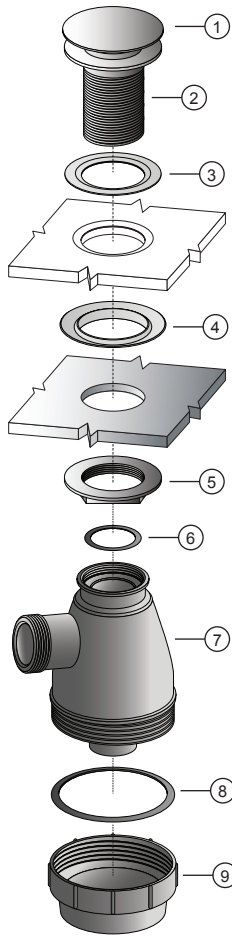

- 1) Touch Stopper
- 2) Touch Body (no overflow)
- 3) Gasket
- 4) Gasket
- 5) Lock Nut
- 6) Gasket
- 7) Trap Body
- 8) Gasket
- 9) Trap Cup

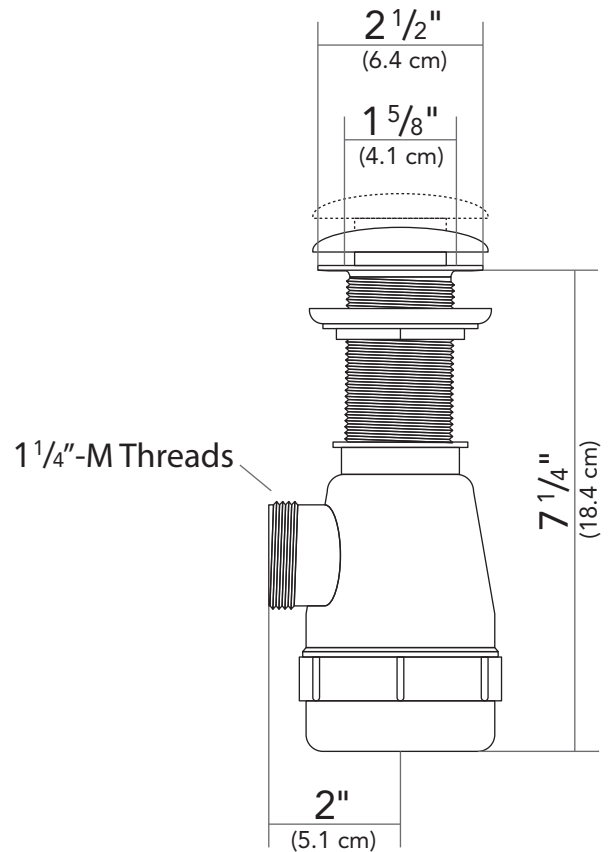

PROPER FINISH CARE

Your new faucet or accessory is protected by a clear-coat. To clean it, you only need to wipe it with a damp, soft cloth. NEVER use any abrasive cleaners, steel wool, or chemicals (including alcohol or ammonia), as they will harm the finish and void your warranty. If the item will be installed in a salt-air environment (boat exterior), regular cleaning with gentle soap and carnauba wax will prolong the life of the finish.

Visit our web site at www.ambassadormarine.com

Ambassador Marine reserves the right to update specifications, change prices, or make substitutions without notice.

LIMITED WARRANTY

Ambassador Marine faucets and accessories are guaranteed to be free from material and workmanship defects under normal use and service for a period of five (5) years from the date of purchase. This warranty will not apply to faucets or accessories that were improperly installed, misapplied, or incompatible with components not manufactured by Ambassador. Faucet failures due to foreign debris is not covered under the terms of this limited warranty. Ambassador will not warrant any faucet or accessory that is physically damaged, or altered outside the Ambassador factory.

Returns are to be shipped postage prepaid to Ambassador Marine's service center at: 1173 Calle Suerte, Camarillo, CA 93012.

A Return Authorization Number is required and must be clearly visible on the shipping carton.

Absolutely no credit or payment will be allowed for consumers on any item deemed defective. Ambassador Marine's obligation is limited to the repair or replacement of the defective item only, at Ambassador Marine's sole discretion. All returns will be examined and/or tested under Ambassador Marine test criteria. Replacements will be shipped freight prepaid.

This limited warranty is in lieu of all other warranties, expressed or implied, and no other person is authorized to give any other warranty or assume obligation or liability on Ambassador Marine's behalf. Ambassador Marine shall not be liable for any labor, damages, or other expenses, nor shall Ambassador Marine be liable for any indirect, incidental or consequential damages of any kind incurred by the use or sale of any defective product.

This limited warranty covers Marine Products sold or distributed in the United States and Canada only. Customers who purchase Ambassador Marine products sold by distributors in other countries must consult their local distributors for their warranty policy. This warranty is only a representation of the complete Ambassador Marine warranty outlined on the Ambassador Marine website and/or catalog.

INSTALLATION INSTRUCTIONS

Thank you for choosing Ambassador Marine.

Your new Ambassador Marine faucet, sprayer, shower or accessory will give you years of trouble-free performance. Please read these instructions carefully before installing your new item. If you have any additional questions about the installation of this product, please feel free to contact one of our friendly customer service representatives at 800.270.4262.

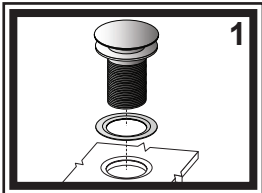
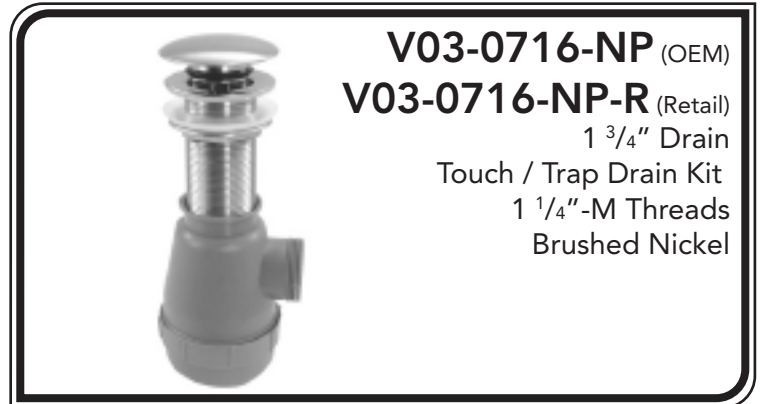

1) Set the touch body assembly with the thin gasket in the drain hole in the sink. NOTE: The thin gasket is supplied for your convenience, however, we recommend using plumber's putty (not included) instead of the gasket. Do not use both the gasket and plumber's putty.

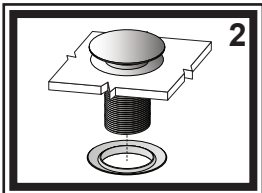

2) From under the sink, slide the thick rubber gasket up onto the threaded touch body assembly and snug against the bottom of the sink.

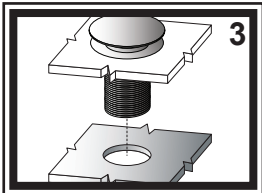

3) Set the sink with the drain assembly and thick rubber gasket into the counter top with the drain going through the hole in the counter top. OPTIONAL- If you are using the optional Mounting Base ring, slide it onto the threaded touch body assembly between the gasket and the counter top.

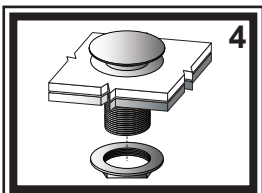

4) Screw the lock nut onto the touch body assembly, but do not tighten completely.

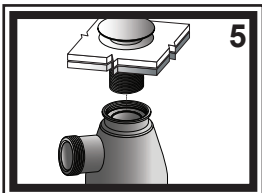

5) Ensure the trap cup is tightly screwed onto the trap body with the rubber gaskets inside the connection. Screw the trap body with the rubber gasket installed onto the threaded touch body securely. Make sure the side port of the trap body is pointed in the desired direction for connecting the waste line, rotate complete assembly if needed. Tighten lock nut, securing the sink and drain assembly to the counter top.

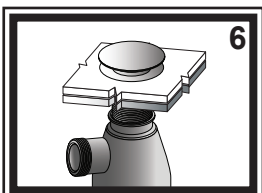

6) Screw 1 1/4" drain pipe or adapter (not included) onto the Body. Use Teflon tape (not included) on the threads to prevent leaks.

Parts

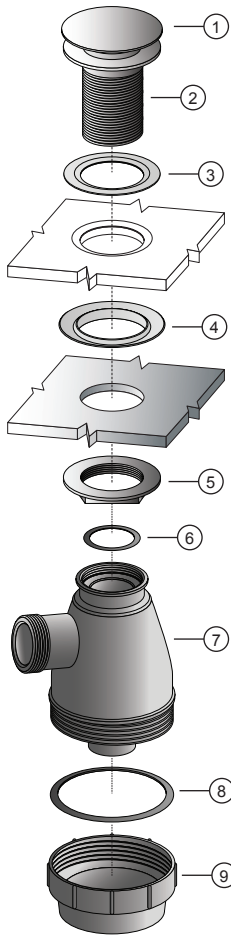

- 1) Touch Stopper
- 2) Touch Body (no overflow)
- 3) Gasket
- 4) Gasket
- 5) Lock Nut
- 6) Gasket
- 7) Trap Body
- 8) Gasket
- 9) Trap Cup

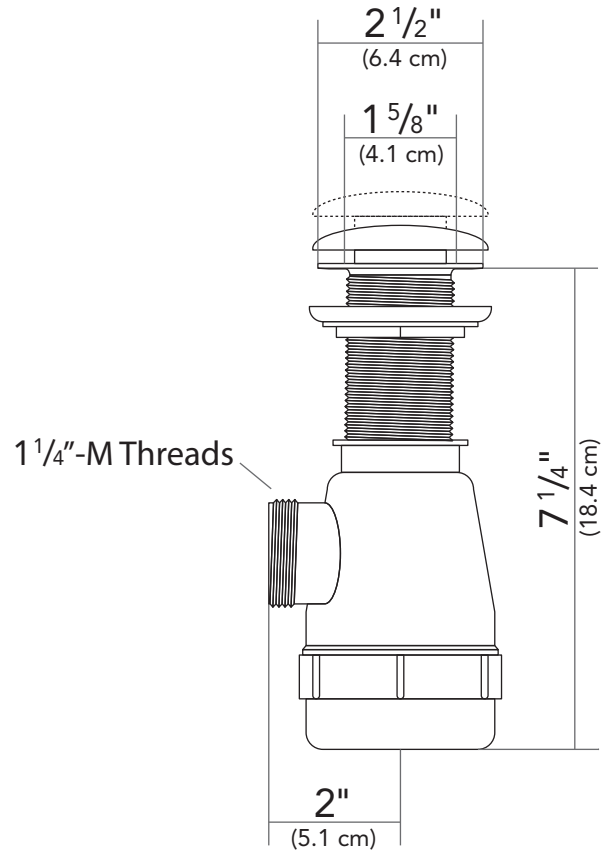

PROPER FINISH CARE

Your new faucet or accessory is protected by a clear-coat. To clean it, you only need to wipe it with a damp, soft cloth. NEVER use any abrasive cleaners, steel wool, or chemicals (including alcohol or ammonia), as they will harm the finish and void your warranty. If the item will be installed in a salt-air environment (boat exterior), regular cleaning with gentle soap and carnauba wax will prolong the life of the finish.

Visit our web site at www.ambassadormarine.com

Ambassador Marine reserves the right to update specifications, change prices, or make substitutions without notice.

LIMITED WARRANTY

Ambassador Marine faucets and accessories are guaranteed to be free from material and workmanship defects under normal use and service for a period of five (5) years from the date of purchase. This warranty will not apply to faucets or accessories that were improperly installed, misapplied, or incompatible with components not manufactured by Ambassador. Faucet failures due to foreign debris is not covered under the terms of this limited warranty. Ambassador will not warrant any faucet or accessory that is physically damaged, or altered outside the Ambassador factory.

Returns are to be shipped postage prepaid to Ambassador Marine's service center at: 1173 Calle Suerte, Camarillo, CA 93012.

A Return Authorization Number is required and must be clearly visible on the the shipping carton.

Absolutely no credit or payment will be allowed for consumers on any item deemed defective. Ambassador Marine's obligation is limited to the repair or replacement of the defective item only, at Ambassador Marine's sole discretion. All returns will be examined and/or tested under Ambassador Marine test criteria. Replacements will be shipped freight prepaid.

This limited warranty is in lieu of all other warranties, expressed or implied, and no other person is authorized to give any other warranty or assume obligation or liability on Ambassador Marine's behalf. Ambassador Marine shall not be liable for any labor, damages, or other expenses, nor shall Ambassador Marine be liable for any indirect, incidental or consequential damages of any kind incurred by the use or sale of any defective product.

This limited warranty covers Marine Products sold or distributed in the United States and Canada only. Customers who purchase Ambassador Marine products sold by distributors in other countries must consult their local distributors for their warranty policy. This warranty is only a representation of the complete Ambassador Marine warranty outlined on the Ambassador Marine website and/or catalog.