

ANDERSEN

STAINLESS STEEL WINCHES

Service Kit for 68, 72ST
"Above Deck" Compact Motor™

*Instructions for Lip Seal
Replacement and
Gearbox Service*



RA710027 Service Kit for 68, 72ST "Above Deck" Compact Motor™

Instructions for Lip Seal Replacement and Gearbox Service

We recommend replacement of the drive shaft lip seal on your Compact Motor™ every 3 to 5 years, depending on usage, in order to avoid water ingress and ensure a long and trouble-free service life.



Safety First! Always disconnect power before performing any service or maintenance work on an electric winch.

Service Kit Contents

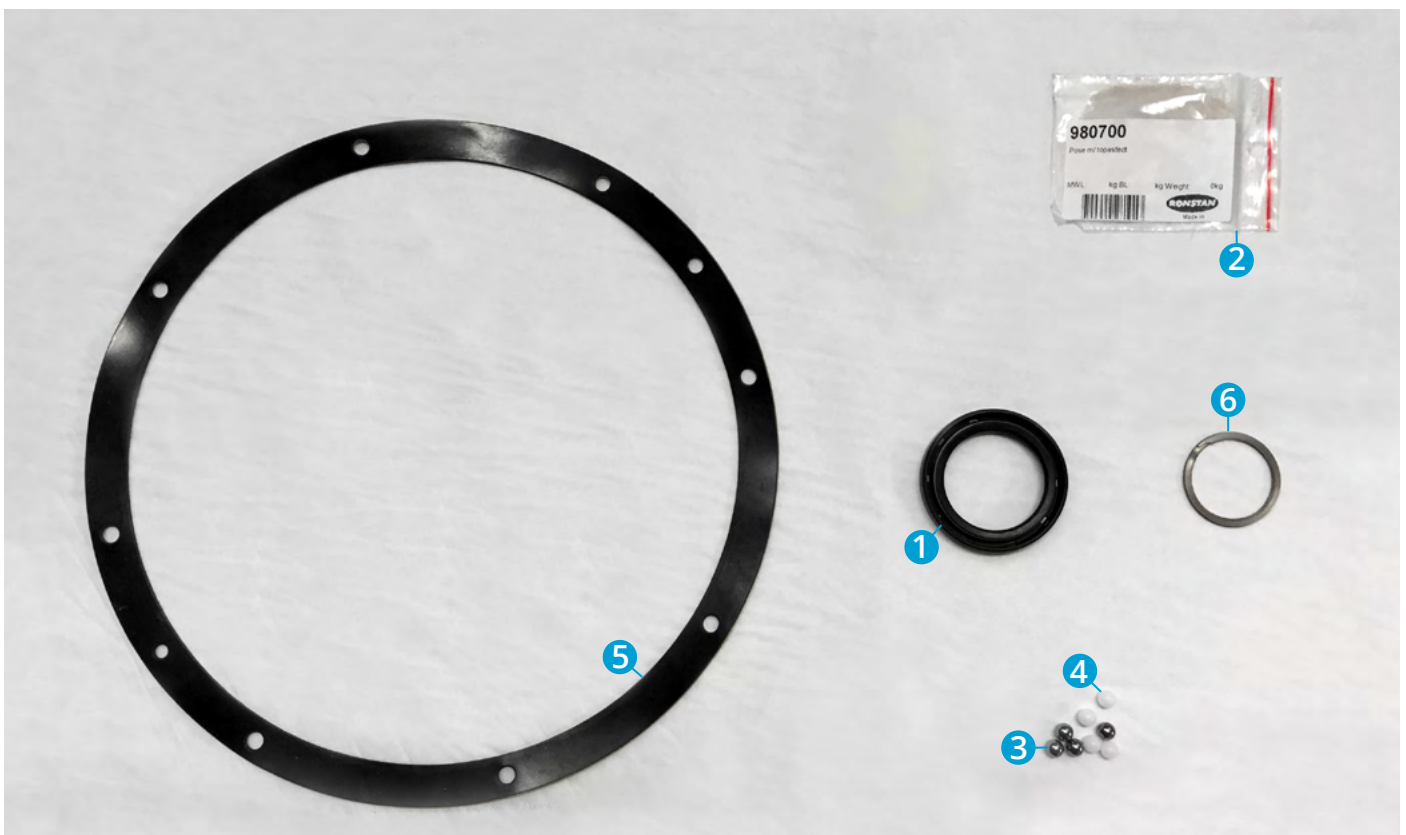

Please take a moment to familiarise yourself with the contents of the RA710027 service kit.

- 1 RD100820 36mm x 50mm x 7mm Lip Seal
- 2 980700 Klüber Isoflex® TOPAS NB52 Grease
- 3 724900 Stainless steel ball bearings, 4 pcs
- 4 724902 Acetal ball bearings, 4 pcs.
- 5 822000 Gasket for 68-72ST
- 6 712800 Circlip

Isoflex® is a registered trademark of Klüber Lubrication München SE & Co. KG

Optional Items: (recommended - may be ordered separately)



Part no. 821811
Pair of support blocks
(12mm x 40mm x 250mm)



Part no. 821810
Mounting tool for Lip Seal



Part no. RA500001-1
Andersen Winch Grease

Other items that you will need:

- Hex keys for M4 and M6 socket head screws
- Small flat screw driver
- Mallet or soft hammer
- Soft cloth or paper towels
- Andersen Winch Grease – Part no. RA500001-1 (may be ordered separately if you don't already have it on board)
- Threadlock, medium strength. To allow for the fasteners to still be removable for future servicing
- Small brush for grease
- Mineral spirits (white spirits) for cleaning and degreasing. Do not use alcohol or other solvents for cleaning.
- 2x M10 screws to help lift up the motor.
- 2x M5 screws to hold the gear support.

Getting Started

1. AFTER DISCONNECTING POWER, remove the winch drum to access the mounting screws and remove the winch from the motor/gearbox unit – if in doubt, see the service manual for your winch.
2. After removing the winch, slide the stainless steel cover up to remove it and expose the motor/gearbox unit.
3. Remove the 8x M8 mounting bolts that secure the motor/gearbox to the deck.
4. Disconnect all wiring connections.
5. Remove the motor/gearbox unit from the deck and place it on a flat, steady surface.

Note: The complete motor/gearbox assembly must be removed from the deck for this servicing procedure.

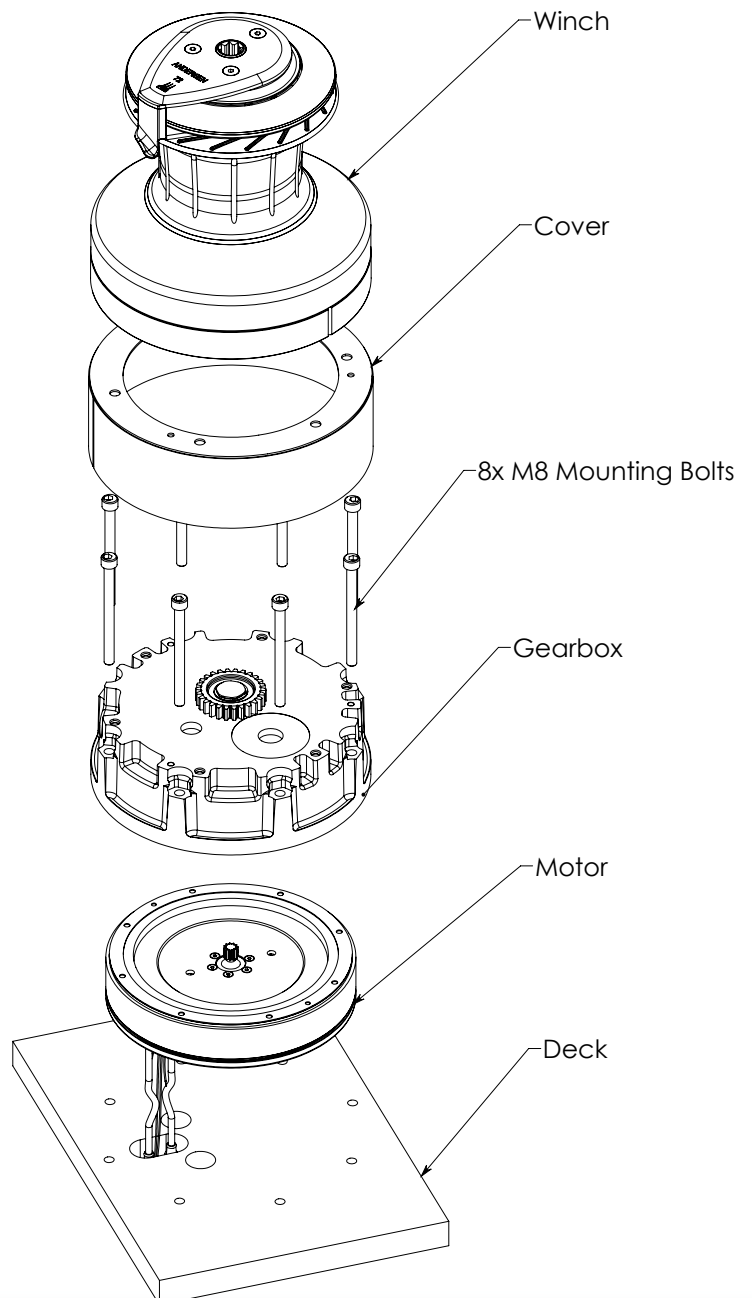

STEP 1

Make a reference mark to facilitate re-assembly.

Before disassembling the motor/gearbox unit, turn upside-down and make a reference mark on the bottom as shown to facilitate re-assembly.

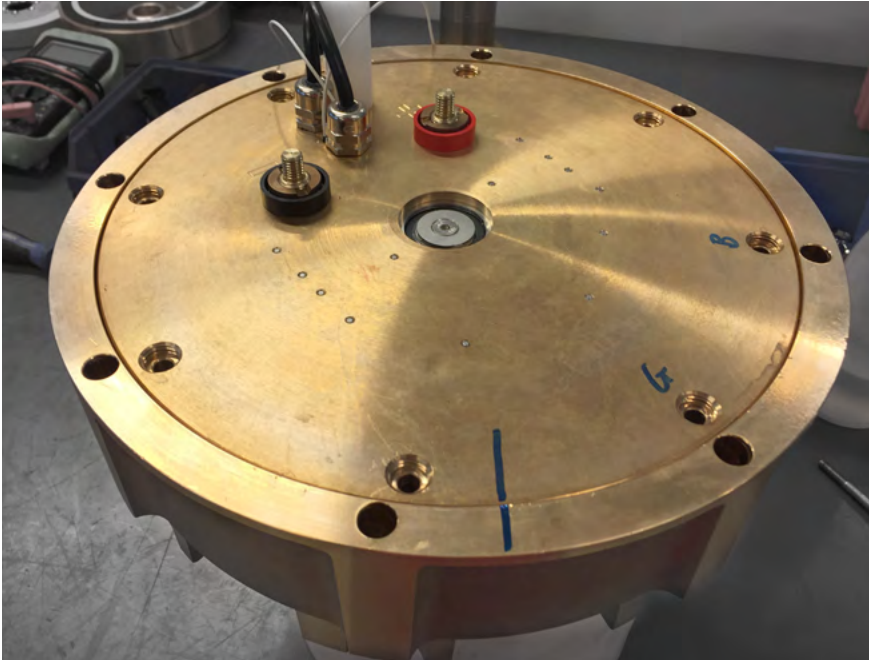

Mark across gearbox housing and motor base

STEP 2

Remove circlip and drive gear.

Remove the circlip as shown, then remove the drive gear from the output shaft. If the original circlip is damaged or lost, a replacement (part number 712800) is provided in the Service Kit for use during re-assembly.

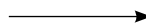

STEP 3

Remove screws joining gearbox to motor.

Turn the motor/gearbox unit upside down and place it on a pair of support blocks so that it is not resting on the drive gear. The support blocks should be 12mm wide x 40mm high x 250mm long – a pair may be ordered separately as part number 821811. Then remove the 8x M6 socket head screws that secure the motor in the gearbox housing.

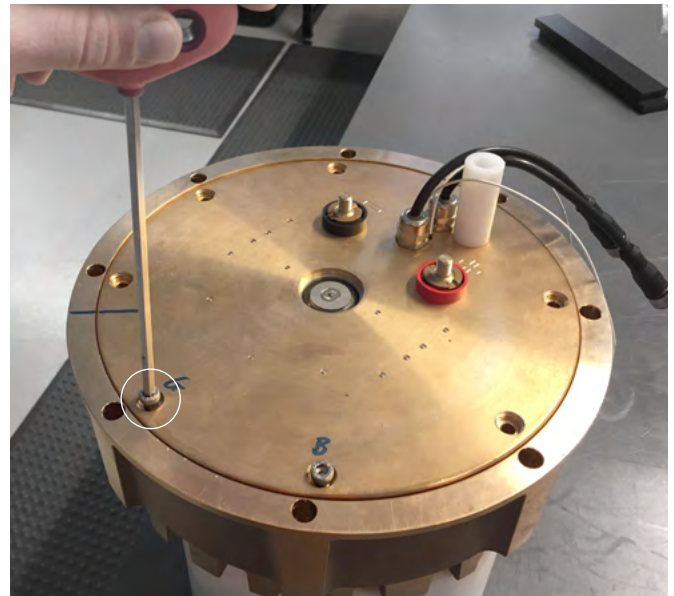
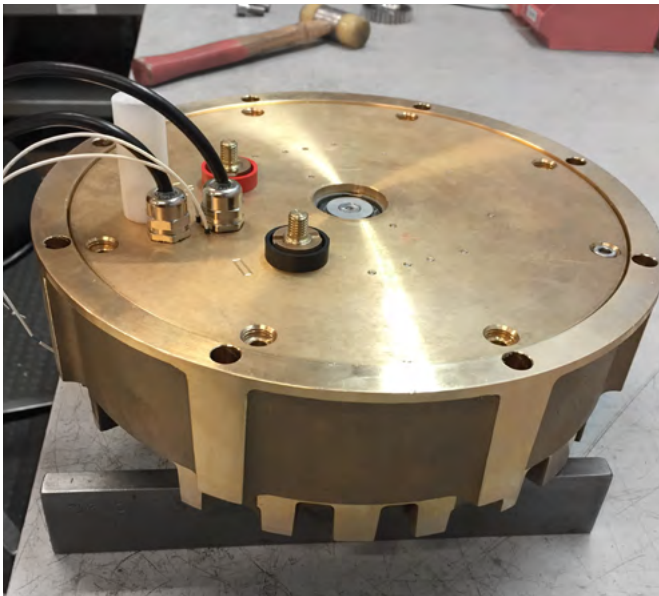

Remove 8x M6 socket head screws

STEP 4

Remove the motor from the gearbox housing.

Insert any 2x M10 screws into the M10 threaded recesses, and use these as handles to lift the motor. If residual deck sealant or adhesive has penetrated between the motor and gearbox, help from a second person may be necessary to detach the two parts. Thoroughly remove any old sealant in order to achieve a clean re-assembly.

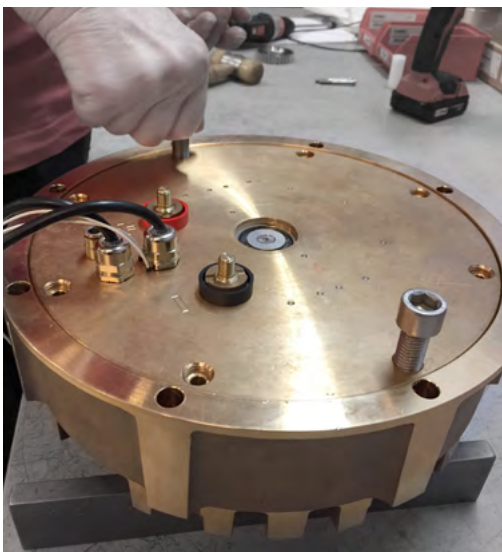

Insert 2x M10 screws to lift the motor



Motor removed from gearbox

STEP 5

Clean the motor unit and gearbox.



Motor Unit: Remove and discard the old gasket. Gently scrape away any remaining adhesive residue, taking care not to let any particles fall into the motor. Using a soft dry cloth or tack cloth, with no degreaser or spirits, remove any dirt or grease from the exposed inside surfaces of the motor unit. Take extreme care not to damage the teeth of the stainless steel planetary drive gear.



Gearbox: Wipe the inside of the gearbox and the planetary gears clean of dirt and grease using a soft cloth and a degreaser.

STEP 6

Remove the planetary gear support.

Remove the 12x M6 countersunk screws from the gear support. Place any 2x long M5 screws into the 2x M5 threaded holes provided on the stainless steel gear support, to use as handles for lifting this part.

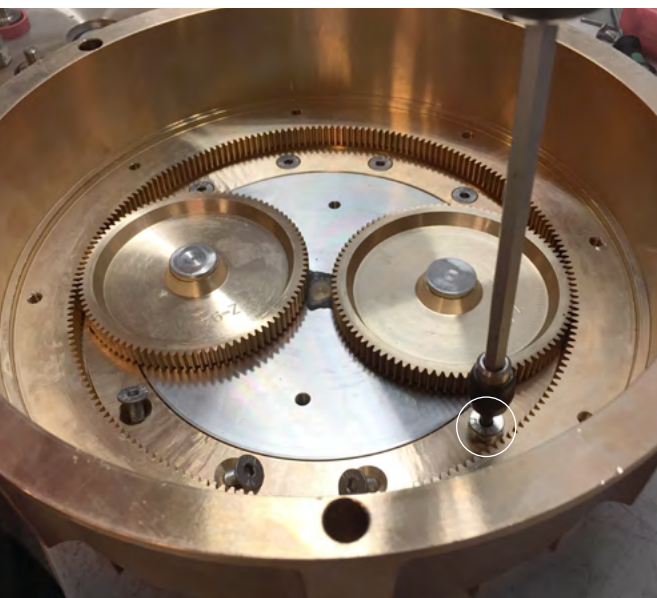

Remove 12x M6 screws

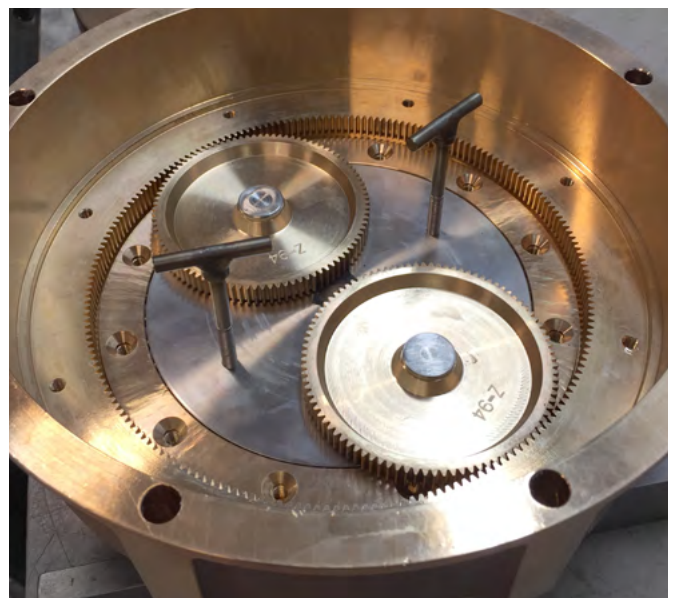

Use any long M5 screws in the two holes provided

STEP 6 continued

Lift the gear support out of the gearbox housing, and place it on a flat surface (no support blocks necessary).

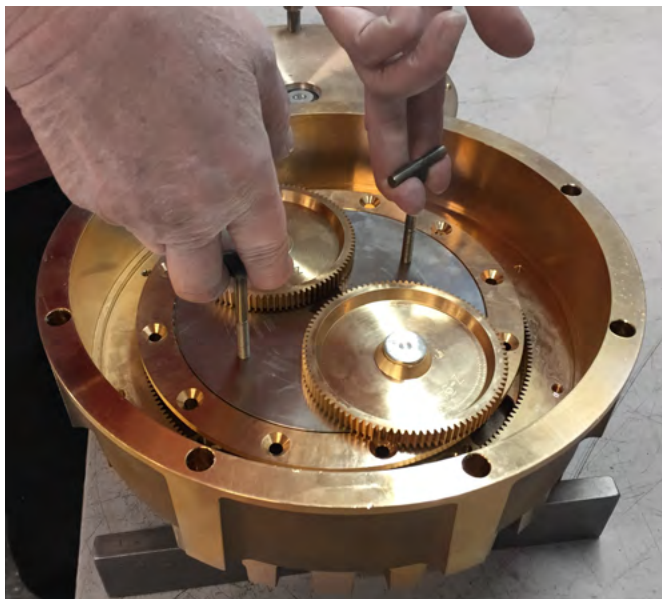

STEP 7

Remove the old lip seal.

Turn the gear box upside down and remove the old lip seal by prying it out with the help of a screwdriver, taking care not to scratch or gouge the metal surface around it. The seal will be damaged/destroyed during this operation and can not be re-used.

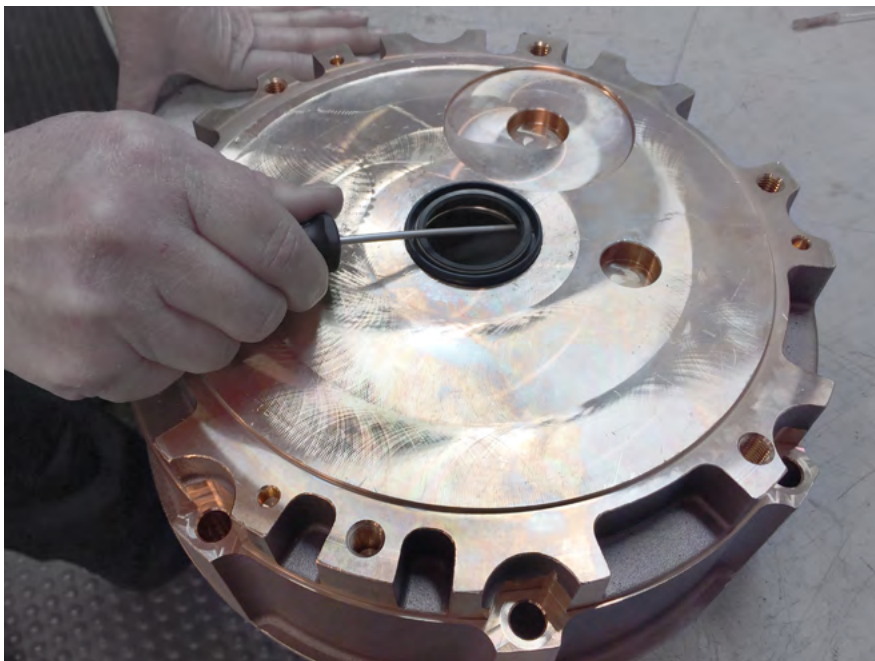

Remove old lip seal using a flat screwdriver

STEP 8

Fit the new lip seal.

Locate the new lip seal, part number RD100820 (provided in the Service Kit). With its open groove facing up, align it accurately and gently press it completely into the recess in the gearbox so that it remains perfectly flush with the external surface of the gearbox. Do not use any grease during this step.

The optional mounting tool, part number 821810, can be used to help fit the seal.

1. Check which end of the tool has the correct diameter to fit your lip seal. Place the new lip seal, with its open groove facing up, onto that end of the tool.
2. Use the tool to insert the seal into the recess. The end of the tool will fit in the hole, accurately aligning the seal as it is inserted.
3. Tap with the help of a soft hammer to fit the seal perfectly and completely into position, flush with the external surface of the gearbox.
4. The seal must be perfectly flush with the cover plate, otherwise the drive gear and attached planetary gears will not engage properly when re-assembled.

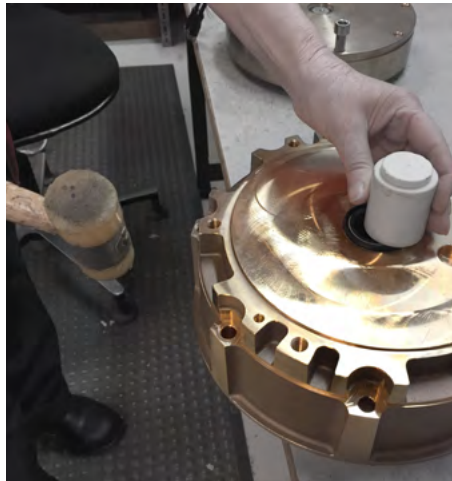

STEP 9

Lubricate the new lip seal.

Turn the gearbox housing upside down again and place it on the support blocks. Locate the TOPAS NB52 grease, part number 980700 (provided in the Service Kit). Apply liberally to the lip seal, the adjacent internal surface, the ball race and the base of the drive gear.

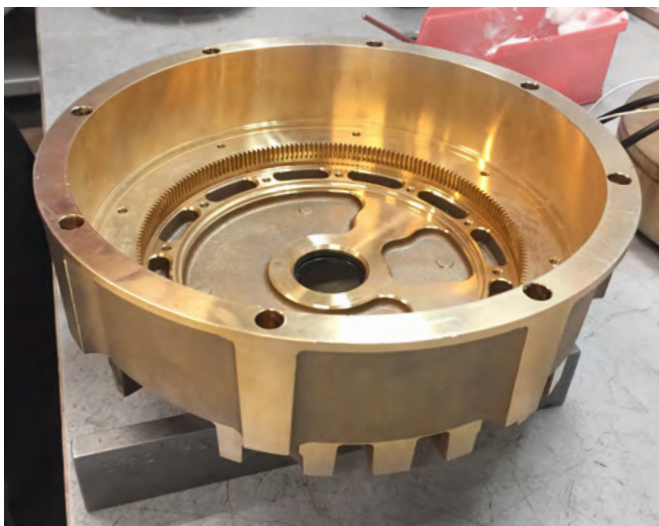

STEP 10

Remove ball bearings (optional).

If the ball bearings still appear to be clean, it is not necessary to remove them – you may skip this operation and proceed directly to **STEP 13**.

If the ball bearings appear dirty, proceed with removal and cleaning. To avoid losing any balls, this is best done over a box or a bucket. Remove the M5 screws that you used to lift the planetary gear support in STEP 6. Hold the stainless steel disc and the bronze ring firmly together, and turn upside down.

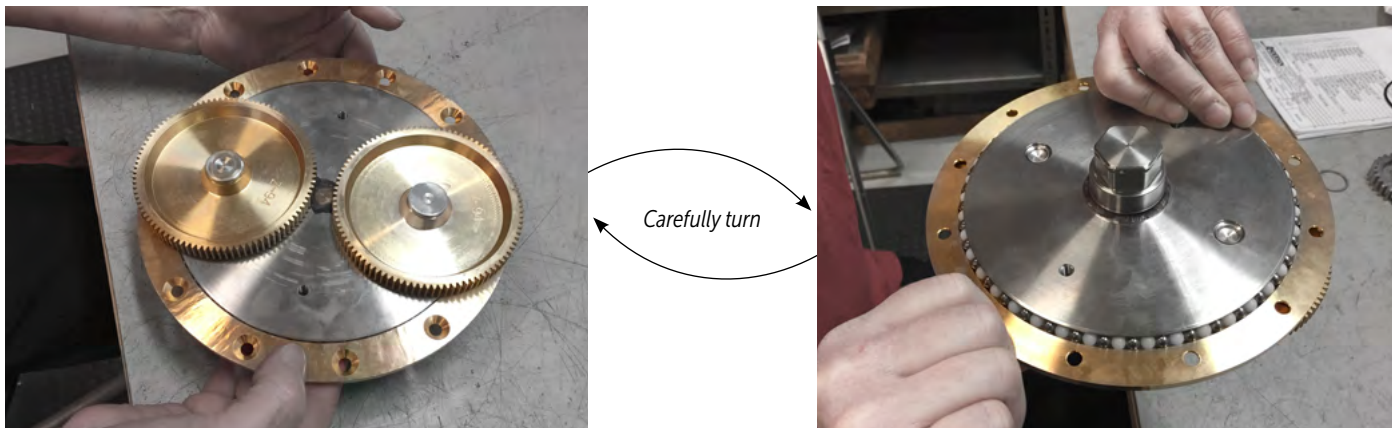

While positioned over the box and holding the stainless disc, gently separate the bronze ring and carefully remove the balls. Help with fingers if they stick within the ball race. There are 41 stainless steel balls and 42 acetal balls.

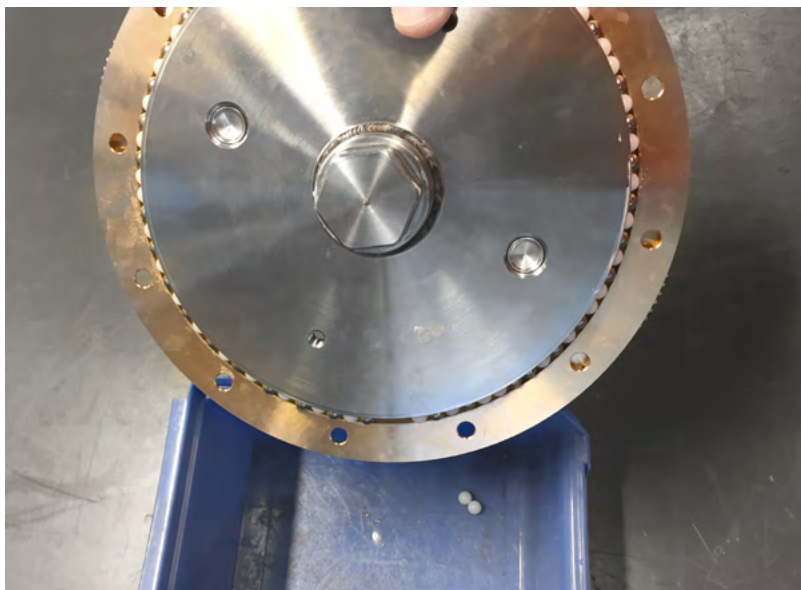

Carefully remove the balls over a box or a bucket

STEP 11

Clean ball bearings and races.

Remove the bronze ring. Clean and degrease the ball bearings, the ball races in the stainless drive unit and the bronze ring.

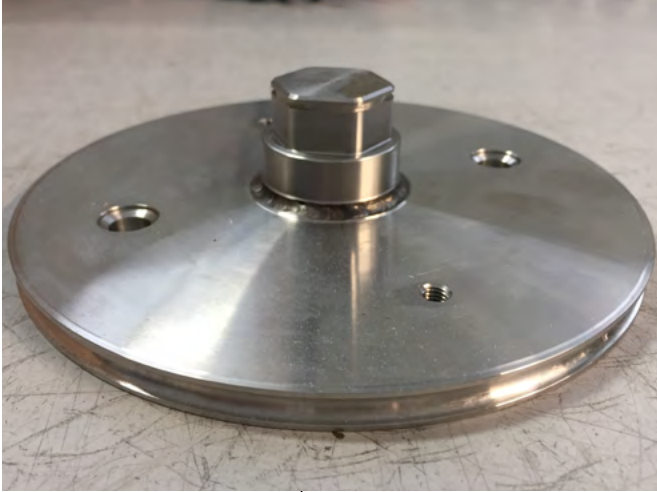

Stainless drive unit ball race



Bronze ring ball race

STEP 12

Load ball bearings.

Place the stainless disc on a flat surface, then place the bronze ring in position from above. The gap between them will be just sufficient to insert the balls. There are 41 stainless steel balls and 42 acetal balls – four spares of each are provided in the Service Kit.

Place the stainless steel balls in the ball race, then insert the white acetal balls between them so the stainless balls do not touch each other. The last acetal ball will sit next to another acetal ball as indicated below. For best results be patient and go slowly, placing the balls gently into position.

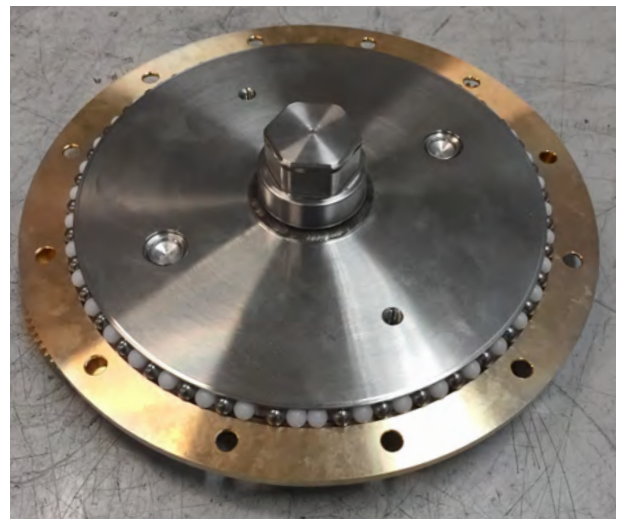
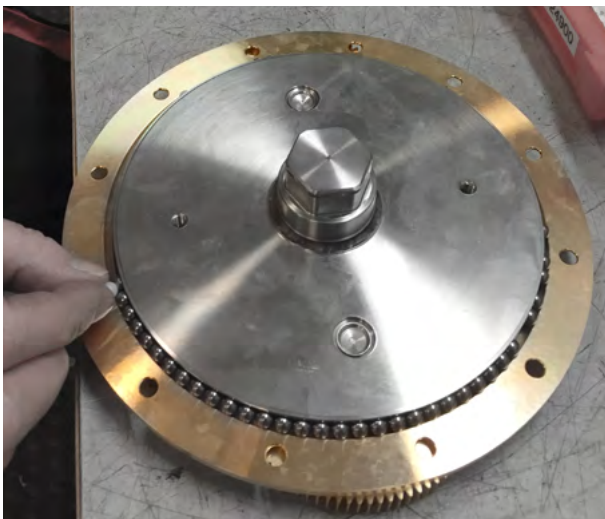

The last acetal ball will sit next to another acetal ball

STEP 13

Lubricate ball bearings.

Holding it by the bronze ring, lift the gear assembly and place it on the two support blocks. Using a small brush, apply Andersen Winch Grease to the ball bearings.

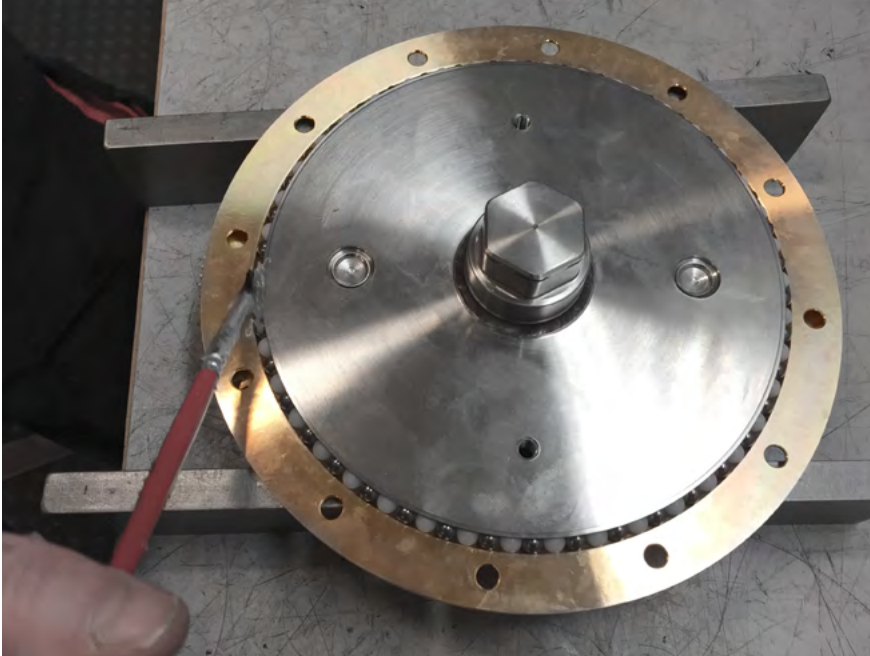

STEP 14

Re-assemble gear support.

1. Hold the bronze ring pressed against the stainless steel gear support disc to prevent the balls from dropping out, and turn it upside down.

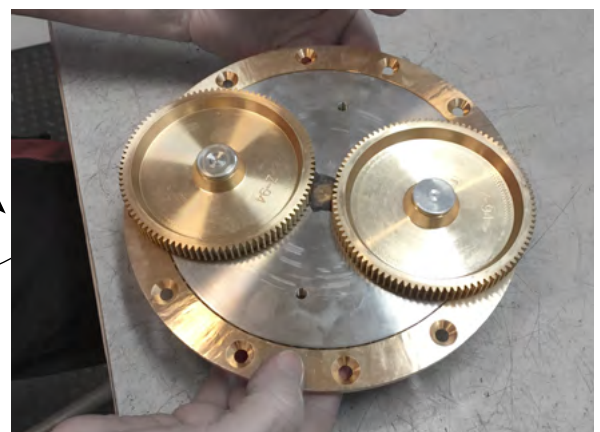
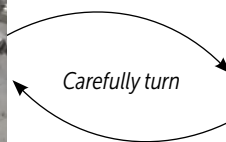
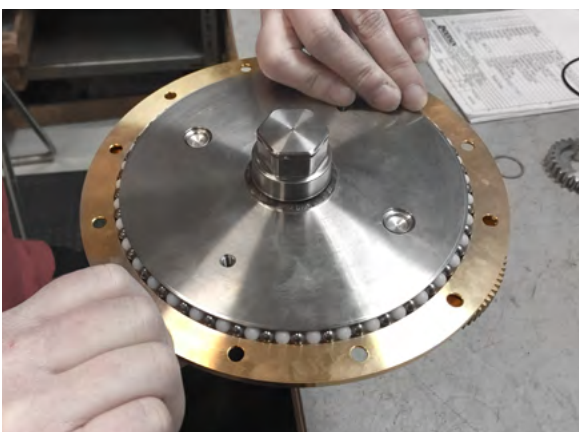

STEP 14 continued

2. Hold the gear support again with the help of your 2x M5 screws, and place it back into the gearbox housing.

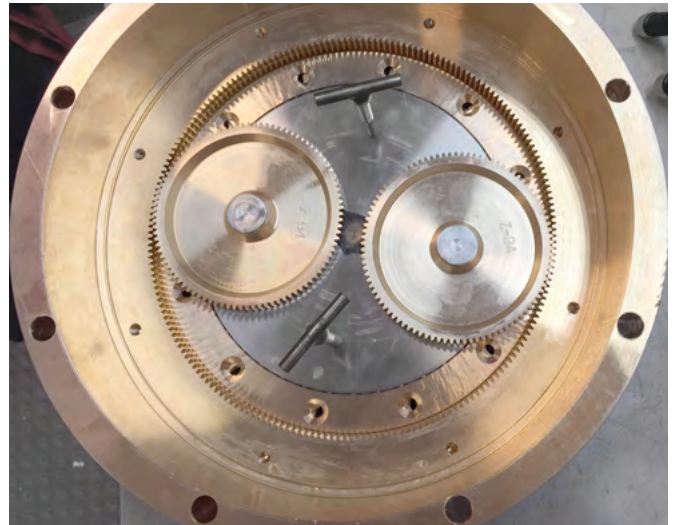

3. Align the countersunk holes in the bronze ring, then insert and tighten the 12x M6 countersunk head screws. Use a drop of threadlock, medium strength, on each screw.

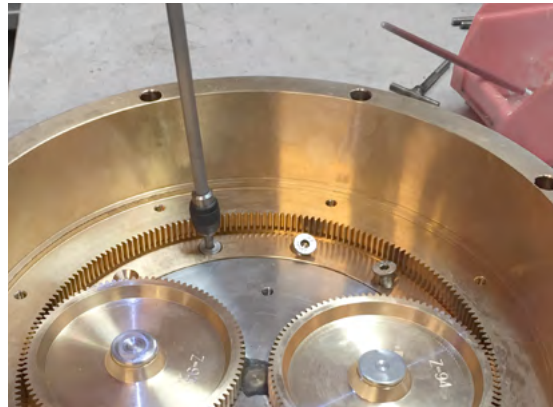

STEP 15

Replace gasket on motor.

Locate the new gasket, part number 822000 (provided with the Service Kit). Ensure that the mounting surface is clean and free of any residue from the old gasket. Place the new gasket in position with the adhesive side down, taking care to align the hole locations before peeling off the backing paper from the adhesive side.

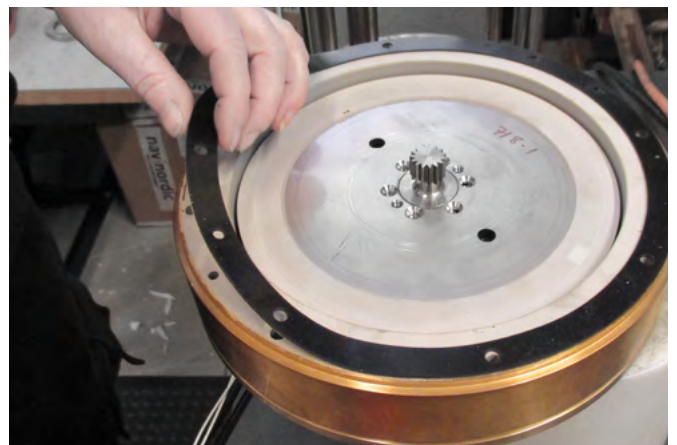
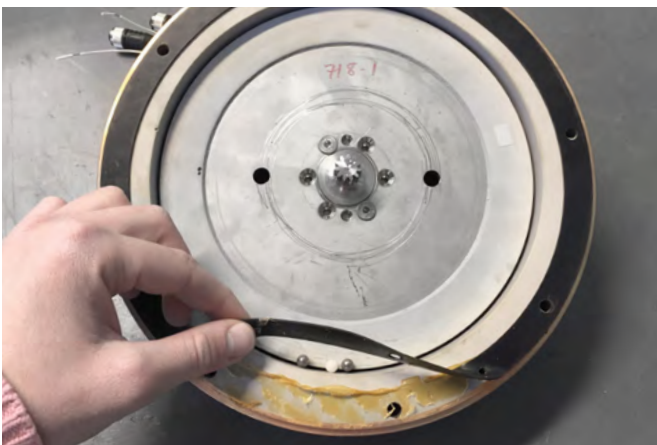

STEP 16

Re-assemble motor and gearbox.

Make sure that the external surface of the motor and the internal surface of the gearbox are clean, to ensure perfect fit and alignment when re-assembled.

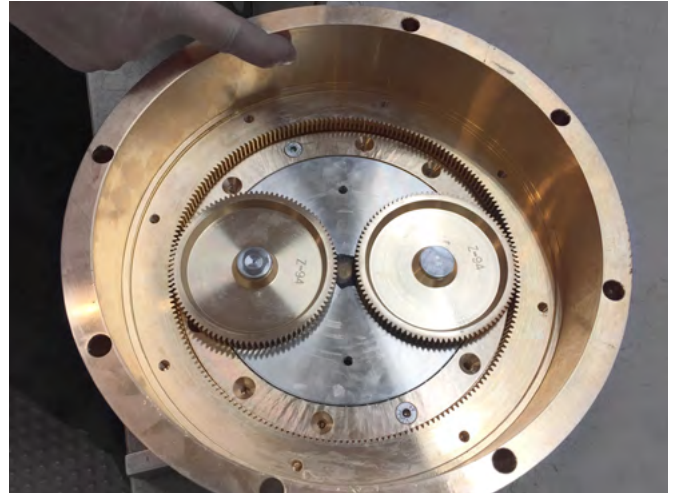
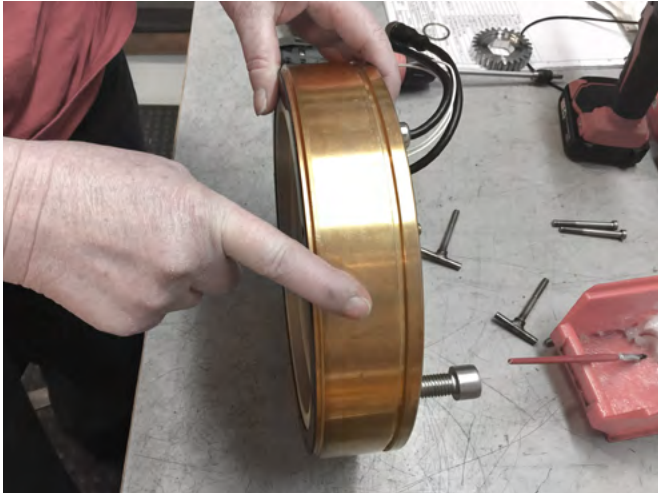

Again as in STEP 4, use your 2x M10 screws as handles to lift the motor. Lower the motor into the gearbox, using your original alignment mark as a positioning reference. You may need to gently rock the assembly to allow the planetary gears to engage as the motor drops into position. Take care to align the holes for the 8x M6 socket head screws that will hold the assembly together. To aid with correct positioning, you may partially insert one of the screws and tap very gently with the soft hammer to rotate the motor slightly within the gearbox housing.

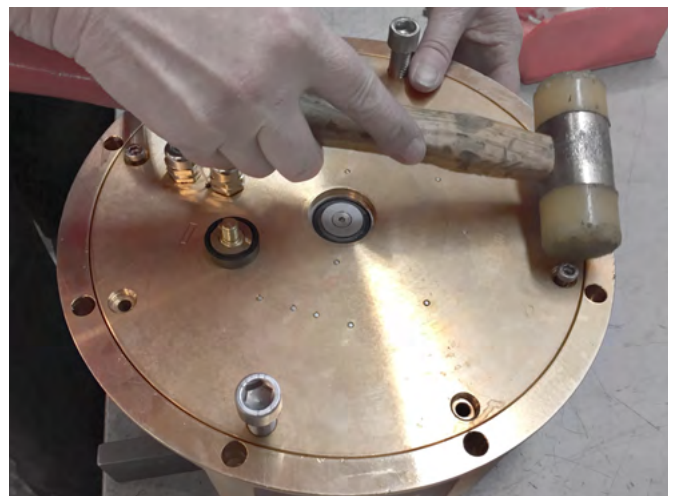

STEP 17

Re-assemble drive gear and circlip.

Turn over the motor/gearbox assembly so the output shaft is facing up. Place the drive gear back in position on the output shaft and secure it with the circlip.

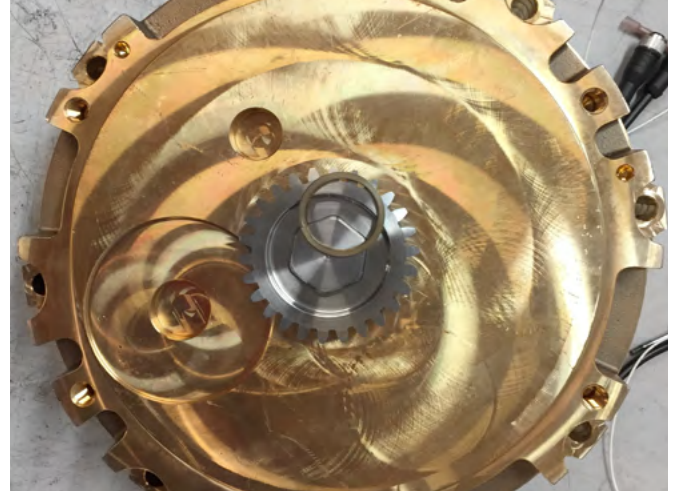
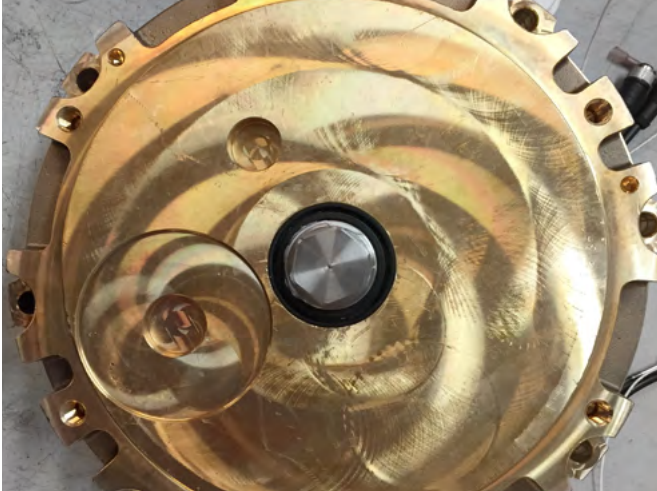

STEP 18

Re-install motor/gearbox unit.

Secure the motor/gearbox unit to the deck with the 8x M8 mounting bolts. Connect push button and power cables, taking care to maintain correct polarity. **Note: incorrect connection of power cables will permanently damage the motor.** See the Compact Motor™ Electric Winch Product Manual for further information (available for download from our website at andersenwinches.com).

Connect power to the motor and test by running at half speed for a few seconds. The motor and gearbox operation should be smooth and quiet.



Safety First! Disconnect power from the motor again before proceeding to the next step.

STEP 19

Fit stainless steel cover and re-install winch.

Slide the stainless steel base cover down over the motor/gearbox unit and re-install the winch on top of the gearbox.

- Test the winch by spinning the drum by hand and operating the winch manually with a handle. The winch should operate smoothly in both gears.
- Connect power to the motor and test the winch with no rope and no load. It should operate smoothly.

Congratulations! You have completed an important maintenance procedure, and your Compact Motor™ electric winch is now ready to deliver many more seasons of enjoyable sailing.

Notes

Contact

Andersen Stainless Steel Winches® are manufactured by Ronstan Denmark ApS.

Jægvænget 36
7100 Vejle
Denmark

www.ronstan.com/andersen-winch
office@ronstan.com.au