



H5000

Operation Manual

ENGLISH



Preface

As Navico is continuously improving this product, we retain the right to make changes to the product at any time which may not be reflected in this version of the manual. Please contact your nearest distributor if you require any further assistance.

It is the owner's sole responsibility to install and use the equipment in a manner that will not cause accidents, personal injury or property damage. The user of this product is solely responsible for observing safe boating practices.

NAVICO HOLDING AS AND ITS SUBSIDIARIES, BRANCHES AND AFFILIATES DISCLAIM ALL LIABILITY FOR ANY USE OF THIS PRODUCT IN A WAY THAT MAY CAUSE ACCIDENTS, DAMAGE OR THAT MAY VIOLATE THE LAW.

Governing Language: This statement, any instruction manuals, user guides and other information relating to the product (Documentation) may be translated to, or has been translated from, another language (Translation). In the event of any conflict between any Translation of the Documentation, the English language version of the Documentation will be the official version of the Documentation.

This manual represents the product as at the time of printing. Navico Holding AS and its subsidiaries, branches and affiliates reserve the right to make changes to specifications without notice.

Copyright

Copyright © 2014 Navico Holding AS.

Warranty

The warranty card is supplied as a separate document. In case of any queries, refer to the brand website of your display or system:

www.bandg.com

Declarations and conformance

This equipment is intended for use in international waters as coastal sea area administered by countries of the E.U. and E.E.A.

The H5000 system complies with the following regulations:

- CE under EMC directive 2004/108/EC
- Level 2 devices of the Radio communications (Electromagnetic Compatibility) standard 2008

The relevant Declaration of conformity is available in the H5000 section on the following website: www.bandg.com



Contents

6	Introduction
6	About this manual
8	System overview
8	H5000 components
9	H5000 Central Processor Unit - CPU
9	Websserver - Network portal
9	Graphic display
10	Race display
10	HV Displays
11	Analog displays
11	Expansion modules
12	Sensor modules
12	Alarm module
13	H5000 Pilot Controller
14	System examples
14	Hydra
15	Hercules
16	Performance
17	Autopilot minimum system requirement
17	Basic System - No H5000 CPU
18	Operation
18	Graphic display
19	Default graphic display pages
26	Data page transition
26	Available data pages
27	Replacing a data page
28	Enabling / Disabling a data page
28	Menus
29	Race timer
31	Man Over Board
32	AIS
35	HV display support
36	Alarms
38	Damping
39	Trip log
39	Log
39	Race display
45	Diagnostics
47	H5000 Pilot Controller
48	Setup
50	Sensor calibration
50	Depth
51	Boat speed
54	Measured sources
56	Environment
56	Masthead unit adjustment
57	Motion correction
57	TWA / TWS Correction tables

58	Heading (compass)
60	B&G Multi Function Display (MFD)
61	System setup
61	Network
63	Units
63	Decimal places (boat speed and sea temperature)
64	Language
64	Time
64	Simulate
65	Restore defaults
65	Global reset
65	About
66	Autopilot
66	Autopilot operation
67	Autopilot modes
69	Response
69	Sailing
71	Steering
74	Webserver
76	Webserver menus
77	CPU software upgrade
78	Webserver help files
79	Operating variables
82	Backstay
84	Boom angle
84	Boom Vang
85	Chain length
85	Code zero
86	Cunningham
87	Daggerboard port position
87	Daggerboard starboard position
89	Forestay
91	Inner Forestay Halyard Load
91	Inner Forestay Load
91	Jib Furl
91	Jib Halyard Load
93	Mast Cant angle
94	Mast rake
96	Outhaul Load
98	Plow angle
101	Temperature - Internal
102	Temperature – Jacuzzi
102	Temperature – Pool
103	Time to waypoint
103	Timer
111	Example data tables
111	Polar table
112	Boat speed / Heel correction
112	True wind angle correction
112	True Wind Speed correction

112 Downwind correction angle for TWS

113 H-LINK Communications

113 Communication Port Configuration

113 Command Syntax

113 Message Format

118 H5000 Function numbers

122 Maintenance

122 Basic maintenance procedures

123 Winter Storage / Laying Up

1

Introduction

About this manual

This manual is a reference guide for operating the B&G H5000 instrument system. It assumes that all equipment is installed correctly, and that the system is ready to use.

The manual assumes that the user has basic knowledge of navigation, nautical terminology and practices. The manual does not cover basic background information about how equipment such as radars, echo sounders and AIS work.

Important text that requires special attention from the reader is emphasized as follows:

→ **Note:** Used to draw the reader's attention to a comment or some important information.

⚠ Warning: Used when it is necessary to warn personnel that they should proceed carefully to prevent risk of injury and/or damage to equipment/personnel.

2

System overview

The H5000 instrument and autopilot systems combine unique sailing features with race-proven technology in a straightforward package. Developed for blue water cruisers and racing yachts alike, the range brings powerful system options to match your exacting requirements. From an ultra-fast CPU to a convenient web-browser interface access, full-color and custom displays and a dedicated autopilot controller, the H5000 system was developed to provide the best instrument and autopilot system available. The H5000 range comprises several units which network with other onboard electronics including the Zeus range of chart plotters.

The H5000 system is driven by a powerful Central Processing Unit (CPU) reaching speeds up to 50 times greater than its predecessor, with Hydra, Hercules and Performance level software options tailored for all users from serious cruisers to professional racers. It works with B&G's H3000 Wind, Speed, Heel and meteorological sensors for straightforward upgrades. The high resolution H5000 Graphic Display is highly intuitive and delivers information on a 5-inch bonded screen with fast, smooth display updates. The H5000 Race Display provides segmented text, numbers and target indicator for the race information you need in a glance.

The H5000 Autopilot brings the functionality and dedicated sailing algorithms of its record-breaking predecessor, supporting the exact needs of a performance sailboat and its crew – whether short-handed cruising or solo racing. In addition, the H5000 Pilot Controller provides dedicated access to autopilot functions.

B&G's web-browser interface lets you connect your PC or tablet to the network for setup, calibration and control of every part of your H5000 system. It utilizes a familiar web browser interface to allow quick calibration of instruments, easy setup of displays and configuration of features. You can also access online product manuals, data backups and network diagnostics.

H5000 components

- H5000 Central Processor Unit - CPU
- Webserver - Network portal
- Graphic display
- Race display
- HV displays
- Analog displays
- Expansion modules
- Sensor modules
- Alarm module
- H5000 Pilot Computer
- H5000 Pilot Controller

H5000 Central Processor Unit - CPU

The H5000 CPU takes sensor inputs and uses a dedicated processor to calculate and calibrate the data and distribute it to display units and external devices.

Connect a router via the ethernet port to take advantage of the webserver interface via a PC, tablet or smart-phone.

There is a USB port to upgrade the CPU with the latest software.

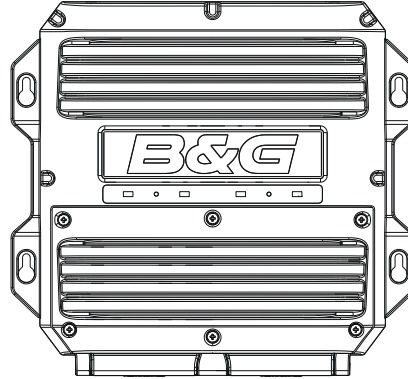

Webserver - Network portal

The browser-based configuration of the H5000 system enables advanced calibration, set-up and diagnostics. Its web-style interface can be accessed via PC, tablet or smartphone.



Graphic display

The H5000 Graphic Display is a 5-inch, sunlight viewable, color display. It shows sailing data in digital or graphical form and can be used to setup and commission the autopilot functions.

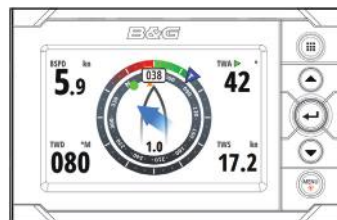

Race display

The H5000 Race Display is a 7 segment display, 5-inch screen designed for viewing essential data at a glance. A dedicated page key allows quick switching between stored pages displaying 2 data values on each page alongside a unique bargraph providing immediate visual indication of performance targets, countdown timer status and more.

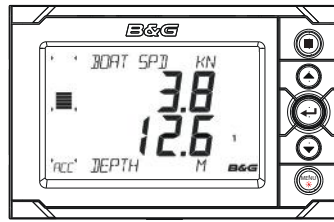

HV Displays

The HVision range of displays are lightweight, single-line data units incorporating B&G's unique HV technology. HV technology ensures the maximum contrast, perfect backlighting and no possibility of condensation. HV displays are the clearest displays available.

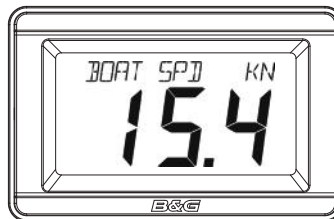

→ **Note:** There are four displays in the HV range, each with their ideal application:

10/10 HV

The 10/10 is a compact display that allows data to be positioned where it is needed, rather than where it fits. Its compact dimensions allow the 10/10 to be installed almost anywhere – typical installation areas are the base of winch pedestals, alongside hydraulic control panels, steering pedestals or as a companionway display on the smaller yacht.



20/20 HV

The latest generation of the classic 20/20 mast display. The 20/20 is the de facto standard for mast displays on yachts up to 70' (21m). The 20/20 is also ideal for use as a cockpit, saloon or bridge display.

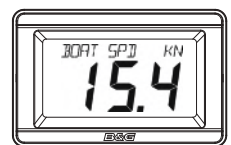

30/30 HV

The 30/30 is designed as a mast display for yachts in the range 60-90' (18-27m) LOA. Providing these larger yachts with the perfect size of display. The 30/30 is also the ideal display for deck or bridge displays on super yachts.

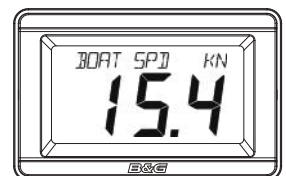

40/40 HV

The 40/40 is the largest instrument display available. Designed specifically for mast mounting applications on super yachts, it also is the ideal display for forward beam mounting on maxi-multi hulls or as a deck or helipad display on large motor yachts.



Analog displays

Before a value will be shown on an analog display ensure that a sensor (source) has been selected via the CPU or Graphic Display. Go to source selection to achieve this.

The analog display backlighting is achieved by a long press of the **MENU** key on any of the Graphic displays.

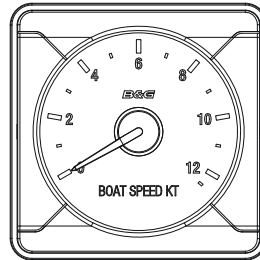

There is a wide range of analog indicators available, all listed below.

- Apparent Wind Angle
- Apparent Wind Speed
- Boat Speed 12.5 Knot
- Boat Speed 25 Knot
- Depth 200 Meters
- Depth Ft / Fathom
- Heading
- Rudder
- True Wind Angle
- True Wind Speed
- Magnified Apparent Wind

Expansion modules

There are two types of Expansion module, Analog and Serial. The modules act as the interface between analog sensors, serial devices and other in and outputs to and from the CPU.

The correct module must be used in conjunction with its corresponding sensors. All modules are powered from the network and can supply power to the sensors connected.

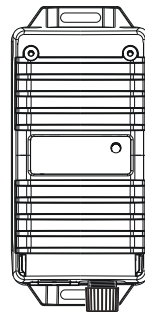

Analog

The analog module has 6 analog inputs and 2 pulse inputs. This allows the unit to act as an interface for masthead units, speed sensor, analog rate-gyros, potentiometer etc.

Serial

The serial module has 2 COM ports, each with input & output. The modules support RS232, RS422, RS485 and NMEA 0183 devices.

Modules can be located wherever is most convenient for the installer and can connect anywhere on the network.

Sensor modules

There are two types of H5000 sensor module.

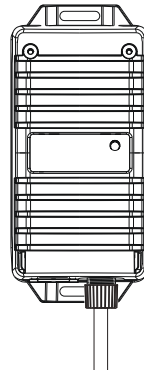

Barometric sensor

Measures the atmospheric pressure, allowing the CPU to record atmospheric pressure changes over varying periods of time.

3D Motion

The Tri-Axis Motion Sensor provides accurate measurement of the heel and trim angles as well as pitch, roll and yaw rates of the yacht, allowing the CPU software to correct the wind data for errors induced by this motion.

Alarm module

The alarm module is a network audible alarm that can be positioned anywhere on the network.

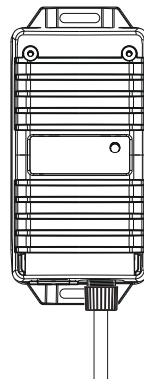

H5000 Pilot Computer

The H5000 Pilot Computer links with the H5000 instrument system. The instrument system transmits sensor information over the network to the Pilot Computer. This information is processed by the Pilot Computer and sends signals to the drive system (linear ram, rotary drive or hydraulic pump) to steer the vessel on the desired heading/course.

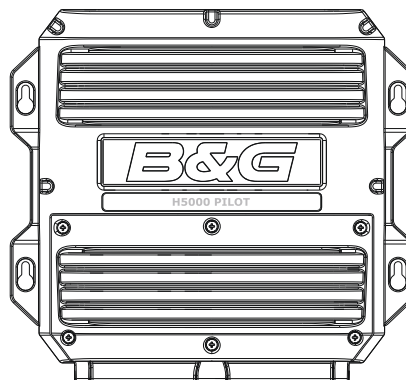

H5000 Pilot Controller

The H5000 Pilot Controller manages all autopilot functions as well as setup and commissioning. Use the H5000 Pilot Controller to select autopilot modes or manually steer the vessel.

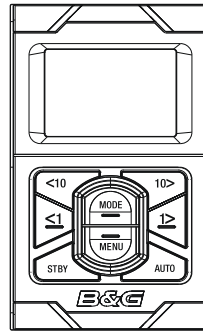

3

System examples

Hydra

An example of a typical H5000 system. At the centre of the system is the H5000 Central Processor Unit (CPU). All sensor information is fed back to the CPU and can be easily controlled and configured via the Graphic display.

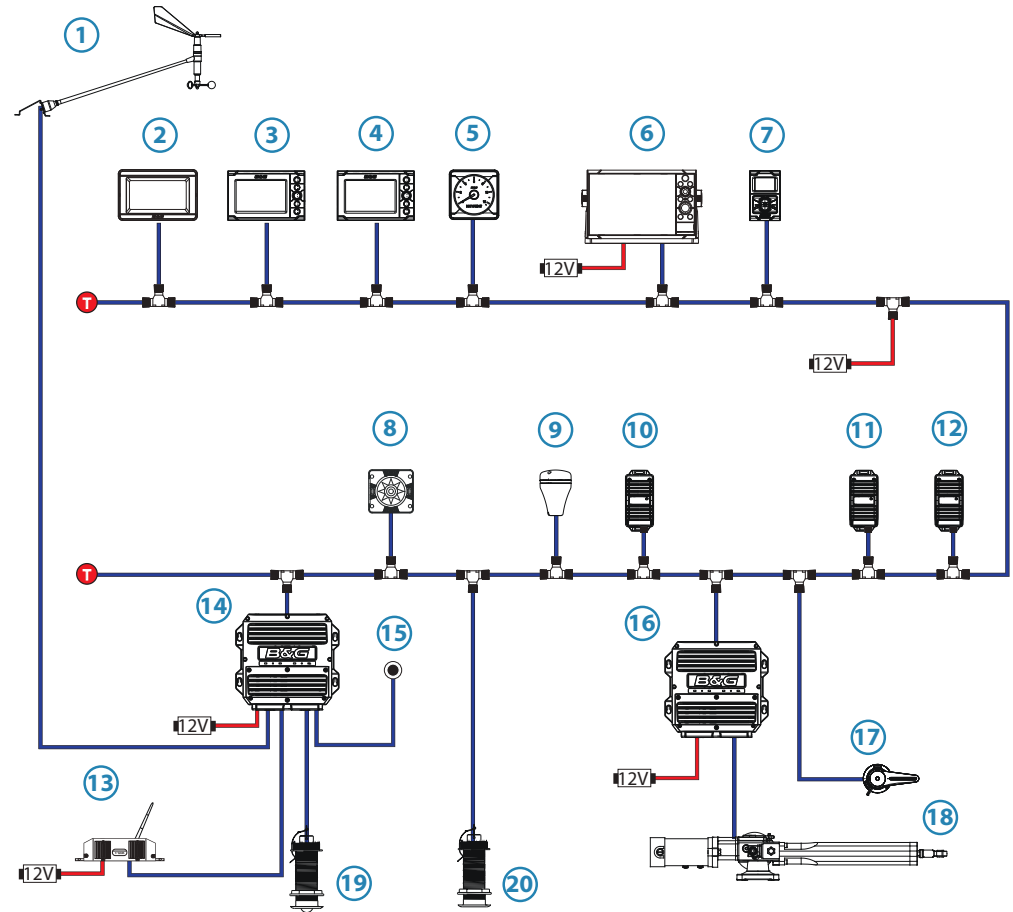

No.	Description	No.	Description
1	Masthead unit	11	3D Motion sensor
2	HV Display	12	Alarm module
3	Graphic display	13	Wireless Access Point or Router
4	Race display	14	H5000 CPU
5	Analogue display	15	Man Overboard Button - MOB
6	Zeus ³	16	H5000 Pilot Computer
7	H5000 Pilot Controller	17	Rudder feedback unit
8	Heading sensor	18	Hydraulic ram
9	GPS antenna	19	Speed sensor
10	High-Resolution Barometer	20	Depth sensor
Ⓡ	Micro-C Terminator	12V	12 Volt DC power supply

Hercules

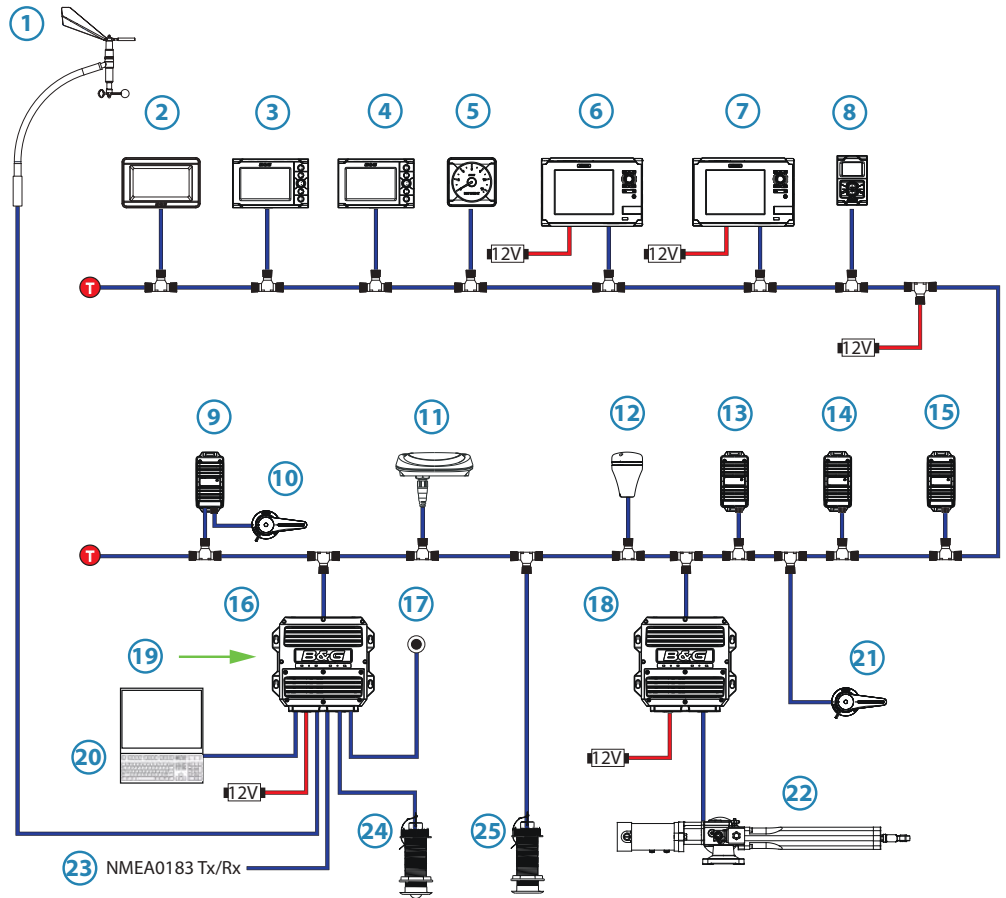

No.	Description	No.	Description
1	Vertical masthead unit	14	Motion sensor
2	HV Display	15	Alarm module
3	Graphic display	16	Central processor unit
4	Race display	17	Man Overboard Button - MOB
5	Analogue display	18	H5000 Pilot Computer
6	Zeus series MFD	19	Webserver
7	Zeus series MFD	20	Deckman
8	H5000 Pilot Controller	21	Rudder reference unit
9	Analog module	22	Hydraulic ram
10	Mast rotation sensor	23	NMEA 0183 Tx / Rx
11	Precision-9 compass	24	Speed sensor
12	GPS	25	Depth sensor
Ⓡ	Terminator	12V	12 Volt DC power supply
13	Barometric sensor		

Performance

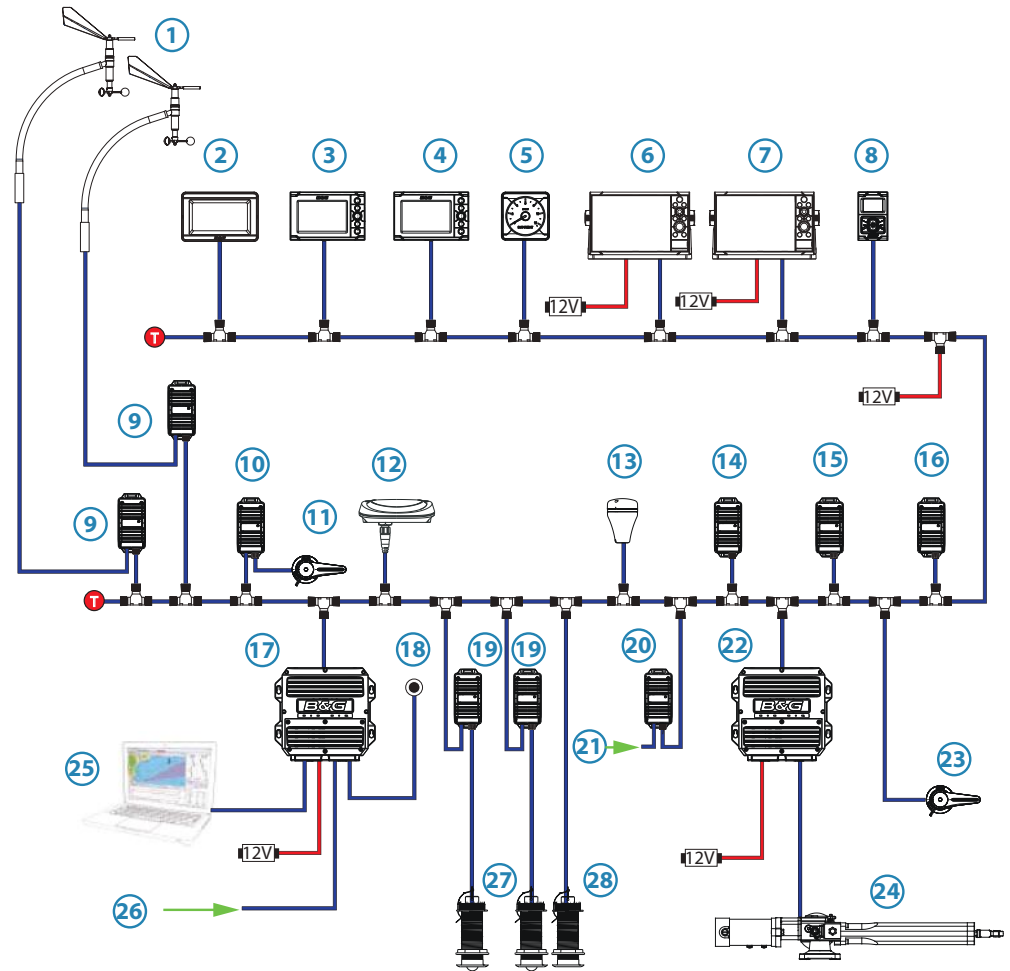

No.	Description	No.	Description
1	Fwd & Aft vertical masthead unit	15	Motion sensor
2	HV Display	16	Alarm module
3	Graphic display	17	H5000 CPU
4	Race display	18	Man Overboard Button - MOB
5	Analogue display	19	Analog module
6	Zeus series MFD	20	Analog module
7	Zeus series MFD	21	Analog sensor *
8	H5000 Pilot controller	22	H5000 Pilot computer
9	Analog module	23	Rudder reference unit
10	Analog module	24	Hydraulic ram
11	Mast rotation sensor	25	Deckman via serial port
12	Precision-9 compass	26	NMEA 0183 Tx / Rx
13	GPS	27	Port & Starboard speed sensor
14	Barometric sensor	28	Depth sensor
T	Micro-C Terminator	12V	12 Volt DC power supply

→ **Note:** * See analog expansion for more information on type and quantity of devices

Autopilot minimum system requirement

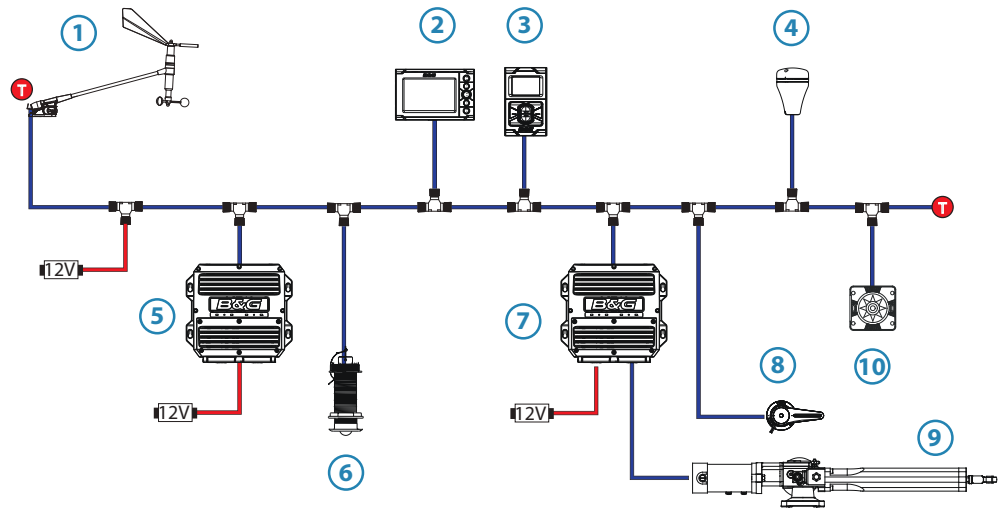

No.	Description	No.	Description
1	Masthead unit	6	Speed sensor
2	Graphic display	7	H5000 Pilot Computer
3	H5000 Pilot Controller	8	Rudder Reference Unit
4	GPS antenna	9	Hydraulic Ram
5	H5000 Central Processor Unit	10	Compass
T	Terminator	12V	12 Volt DC power supply

Basic System - No H5000 CPU

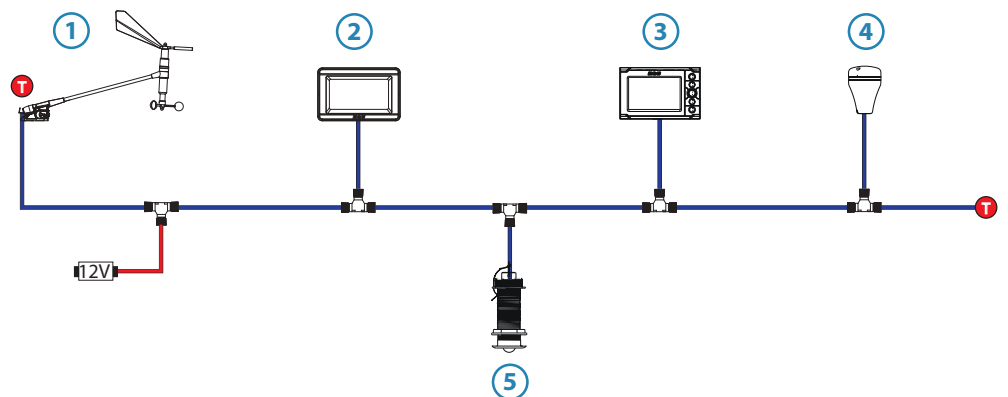

No.	Description	No.	Description
1	Masthead unit	4	ZG100 GPS
2	HV Display	5	DST800 Speed & Depth sensor
3	Graphic Display		
T	Terminator	12V	12 Volt DC power supply

→ **Note:** A system without an H5000 CPU will only provide data from the available sensors on the network and limited functionality. Only those menu options visible on the Graphic Display will be available to the user.

4

Operation



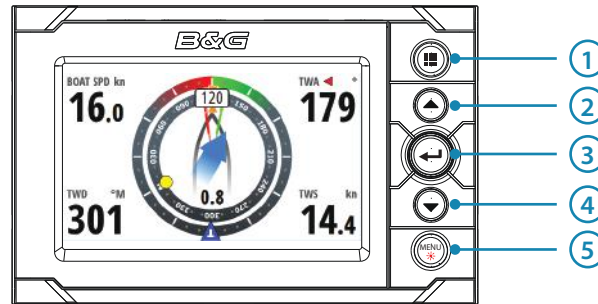

Graphic display



Basic operation

The first display added to the network will go into a startup wizard when it is first powered on. The startup wizard will need to be completed before the display can be used.

Using the wizard, set the desired language, time, units and network source selection.

-  **1 PAGE**
Each short press of the **PAGE** key scrolls through the data pages. When viewing a data page a long press of the **PAGE** key will bring up the pages menu, from here the required page can be selected directly from a list. From any dialog screen, pressing the **PAGE** key navigates back to the data pages. When using a menu the **PAGE** key navigates back a step.
-  **2 UP**
Scrolls up through selected menus / set values
-  **3 ENTER**
Used to enter the selected sub menus and confirm selection
-  **4 DOWN**
Scrolls down through selected menus / set values
-  **5 MENU / LIGHTS**
Single press of the MENU key – displays the Page menu
Double press of the MENU key – displays the Settings menu
Long press of the MENU key - Enters the display setup dialog and light settings menu.

Display group

Light settings are replicated on all displays set to the same group.

Backlight level

Min to Max in 10% increments

Night mode

Alternative display palette for low light conditions.

Night mode color

Red, green, blue, white text color

- ➔ **Note:** Adjusting the backlight settings will effect all other displays in the same display group. See Network groups for more information.

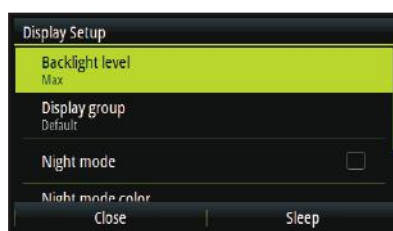

Sleep mode

All of the displays can be placed in Sleep mode via any Display setup dialog.

→ **Note:** Once in Sleep mode a single press of the **MENU** key will turn the displays back on.

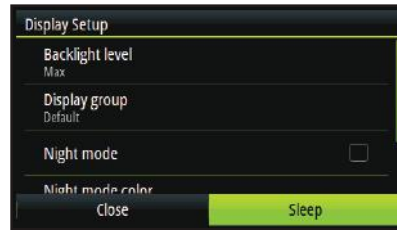

Default graphic display pages

Sail Steer

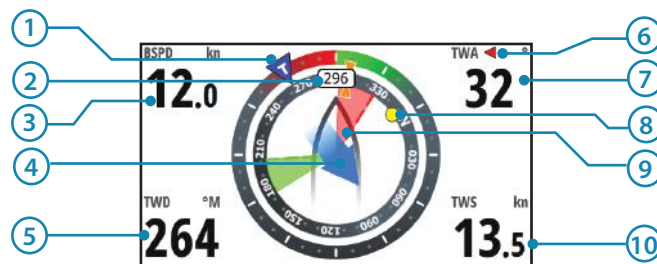

Displayed data

No.	Description	No.	Description
1	True wind indicator	6	Port / Starboard indicator
2	Course / Heading	7	True Wind Angle
3	Boat speed	8	Waypoint
4	Tide set	9	Laylines
5	True wind direction	10	True Wind Speed

→ **Note:** See configuring the Sail Steer page for more information on using this page.

Configuring the Sail Steer page

When navigating to a waypoint you can configure the Sail Steer page to show laylines to aid navigation.

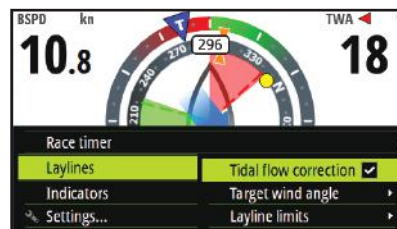

Tidal flow correction

Tidal flow correction will calculate the tidal flow and offset the laylines accordingly.

Target wind angle

There are 4 sources available for target wind angle.

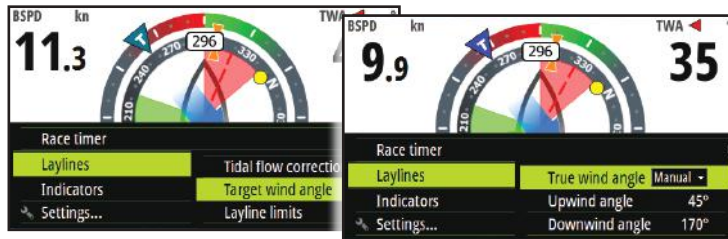

Polar

Takes the target wind angle from your polar table.

Actual

Takes the current value of target wind angle.

Manual

Allows for manually entering upwind and downwind values.

Table

Takes the target wind angle information from the table available in the Zeus and Vulcan series MFDs.

Layline limits

When selected will show a dotted line indicating the minimum and maximum tack/gybe time period either side of the layline. This can be set to 5, 10, 15 & 30 minute increments.

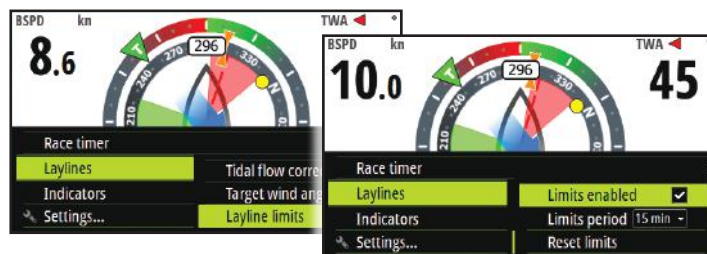

Indicators

Defines which indicators are displayed on the SailSteer page.

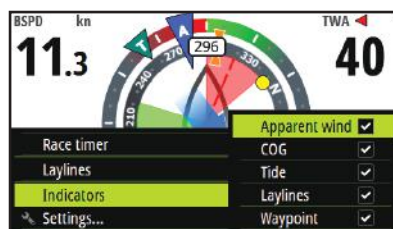

Speed / Depth

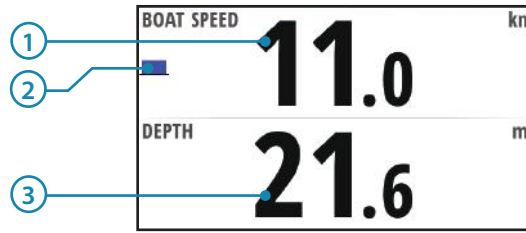

Displayed data

No.	Description	No.	Description
1	Speed	3	Depth
2	Acceleration bargraph		

Wind plot

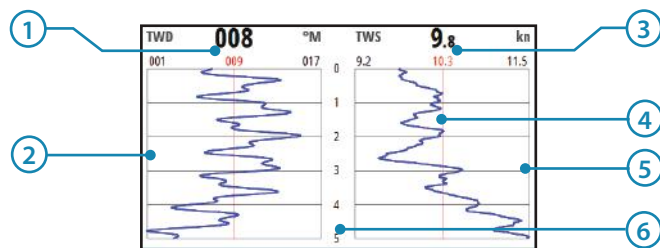

Displayed data

No.	Description	No.	Description
1	True wind direction	4	Mean value
2	True wind direction histogram	5	True Wind Speed histogram
3	True Wind Speed	6	Time period (5 to 60 minutes)

→ **Note:** Wind histogram time periods can be set to show 1, 5, 10, 30 or a 60 minute history. Toggle between the time periods using the **UP/DOWN** keys.

Start line

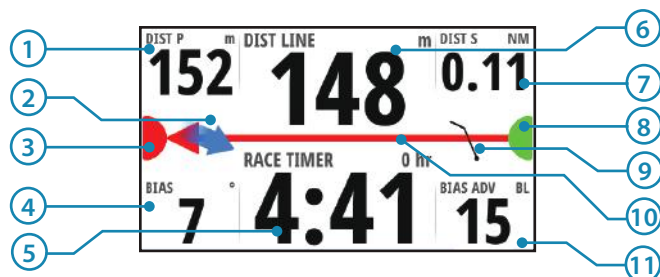

Displayed data

No.	Description	No.	Description
1	Distance to port end of start line	7	Distance to starboard end of start line
2	Tide direction indicator	8	Starboard end start line indicator

3	Port end start line indicator	9	Wind indicator (wind barb)
4	Start line bias angle	10	Start line - Arrow points to favored end
5	Race timer	11	Bias advantage (boat lengths)
6	Distance to start line (perpendicular)		

Setting up a Start line page

The Start Line page is used as a visual aid to boat distance from the start line, tide direction, recommended start end bias and what advantage in degrees and boat lengths the biased end will give.

→ **Note:** Before setting the start line position It is important that the Bow offset is updated to negate the difference between the GPS position and the bow of the vessel.

- 1 Approach the port end of the start line

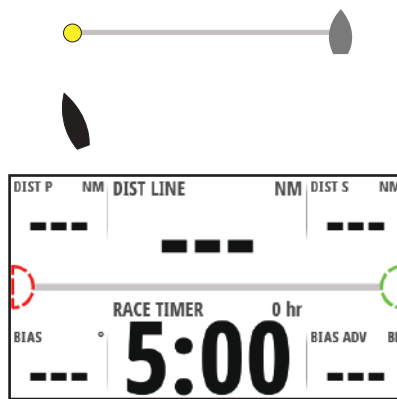

- 2 Select ping from the start Line menu
- 3 Highlight Port end...

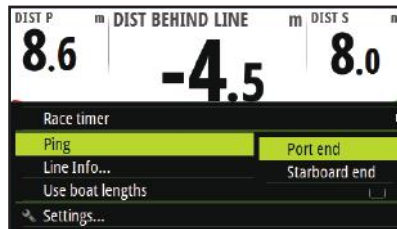

- 4 When the bow touches the start line, press the **ENTER** key.



- 5 The port end mark on the start line screen will go to solid red indicating it has been pinged

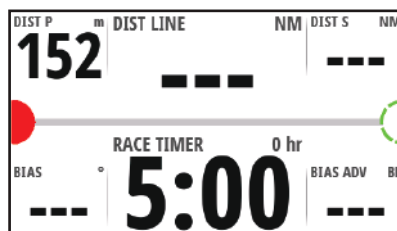



6 Repeat steps 1 to 4 at the starboard end selecting ping starboard end as the bow touches the line



7 The starboard end mark on the start line screen will go to solid green indicating it has been pinged

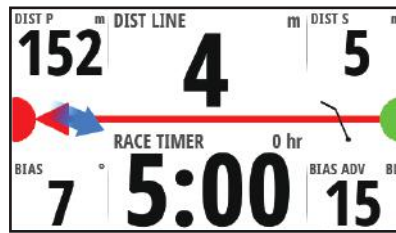

Start line screen explained

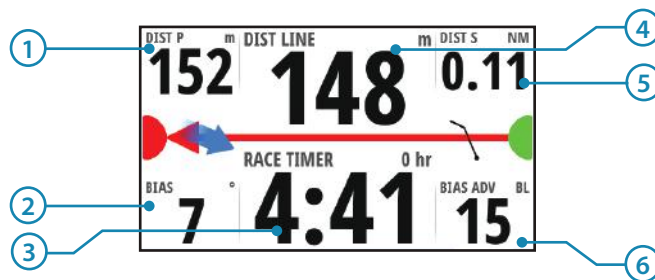

	Start line end not pinged (position not recorded)
	Start line end pinged (position recorded)
	Start line end stale (historic start line position) Start line end becomes stale at 23:59 hrs on the day it was recorded but remains valid.
	Invalid start line - One or more ends invalid (position not recorded)
	Start line - Blue - Square line - No bias advantage
	Start line - Red & Arrow left - Port end bias
	Start line - Green & Arrow right - Starboard end bias
	Tide direction indicator
	Wind speed and direction indicator (wind barb)
1	DIST P: Distance to port end of start line

2	BIAS: Start line bias angle
3	Race timer
4	DIST LINE: Distance to start line (perpendicular)
5	DIST S: Distance to starboard end of start line
6	BIAS ADV: Bias advantage (boat lengths)

Depth history

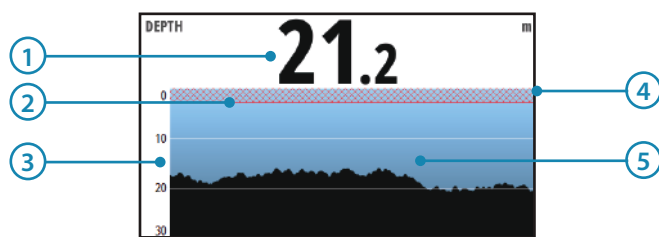

Displayed data

No.	Description	No.	Description
1	Current depth	4	Water line
2	Shallow water limit	5	Depth histogram
3	Depth scale		

→ **Note:** Depth histogram time periods can be set to show 5, 10, 30 or a 60 minute history. Toggle between the time periods using the **UP/DOWN** keys.

Highway

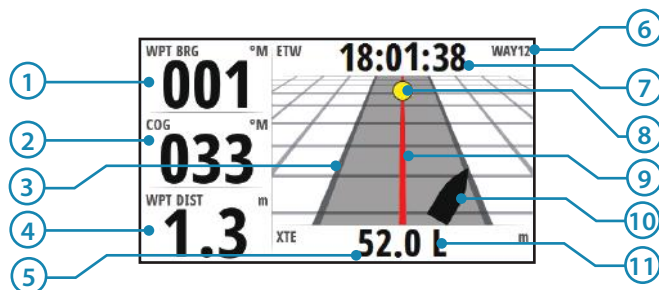

Displayed data

No.	Description	No.	Description
1	Waypoint bearing	7	Estimated waypoint arrival time
2	Course over ground	8	Waypoint
3	Off course limit (user setting)	9	Course line

4	Distance to waypoint	10	Vessel indicator
5	Cross track error	11	XTE correction direction Left or Right
6	Waypoint name		

Tide

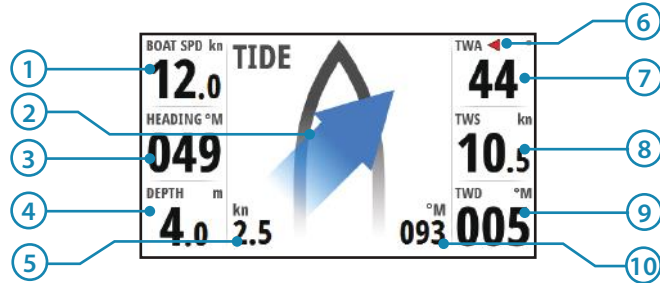

Displayed data

No.	Description	No.	Description
1	Boat speed	6	TWA Port / Starboard indicator
2	Tide angle relative to vessel	7	True Wind Angle
3	Heading	8	True Wind Speed
4	Depth	9	True wind direction
5	Tide rate	10	Tide direction

Autopilot

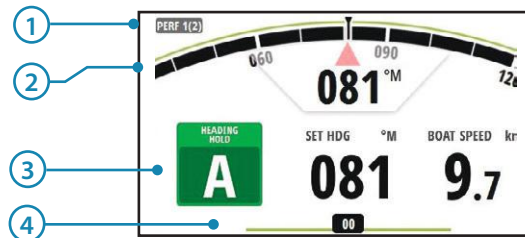

Displayed data





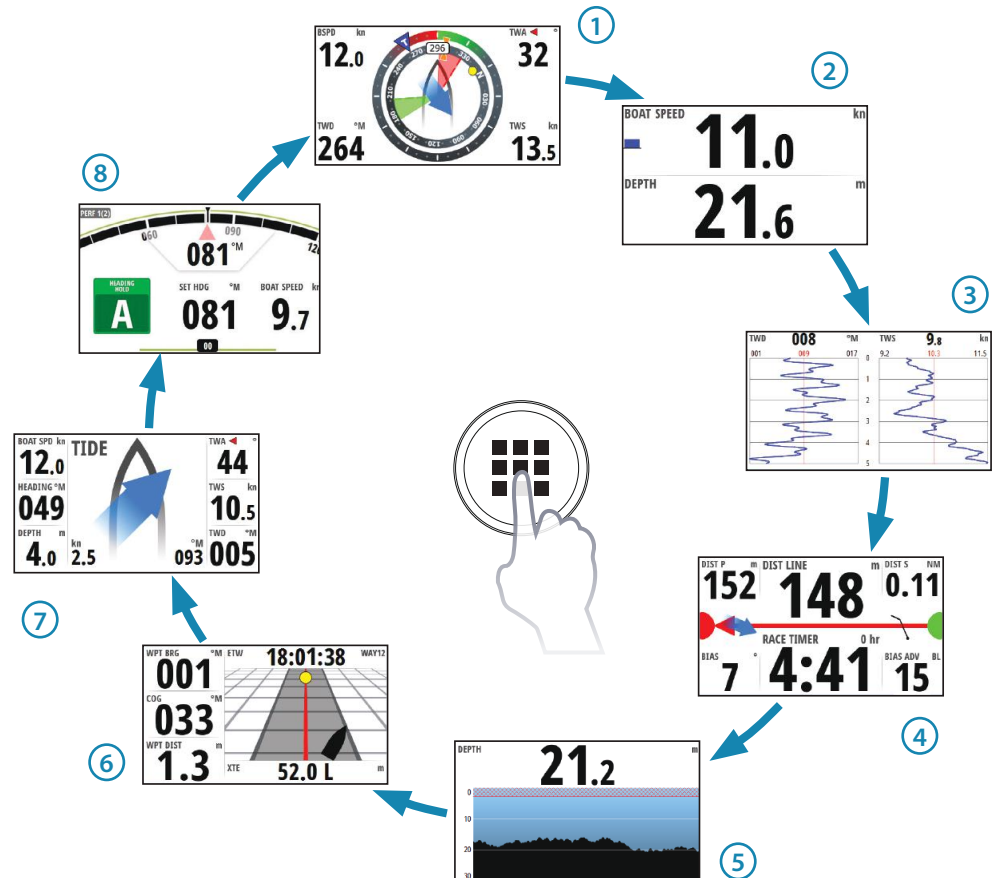



No.	Description
1	Performance level
2	Heading indicator, analog and digital
3	Autopilot mode indicator
4	Rudder indicator, analog and digital

Data page transition



Available data pages

- | | | | | |
|---|--|----------------------------------|--|------------------------|
| 1 | | Sail steer (default) | | 2x2 grid offset* |
| 2 | | Speed / Depth 2x1 grid (default) | | 3x3 grid* |
| 3 | | Wind plot (default) | | 1+3 digital* |
| 4 | | Start line (default) | | 1+6 digital* |
| 5 | | Depth history (default) | | Bars + 2* |
| 6 | | Highway (default) | | Centre analog* |
| 7 | | Tide (default) | | Analog + 2* |
| 8 | | Autopilot status (default) | | Analog + 3* |
| | | Performance target** | | Dual analog* |
| | | Laylines** | | Composite wind + 3* |
| | | Satellites | | Composite wind + 2* |
| | | Weather | | Sail Steer + 3* |
| | | Composite wind | | Sail Steer + 2* |
| | | AIS | | Center Composite Wind* |

- | | |
|---|---|
|  Single time plot* |  Center Sail Steer* |
|  Dual time plot* |  Dual Analog (Composite Wind)* |
|  Full screen* |  Dual Analog (Sail Steer)* |
|  2x1 grid* |  2x2 grid* |

→ **Note:** * indicates user configurable page.

→ **Note:** ** only available on a Hercules or performance system.

Replacing a data page

- 1 Go to the pages menu.
- 2 Highlight the page you wish to replace

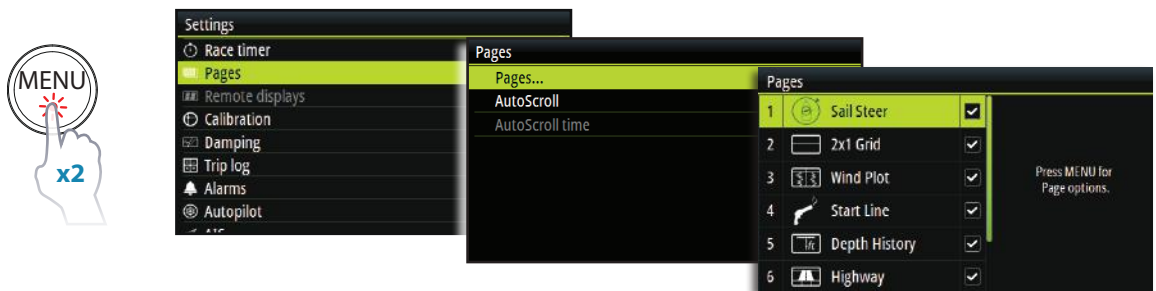

- 3 Press **MENU**
- 4 Highlight Replace and press the **ENTER** key
- 5 Highlight the desired page and press the **ENTER** key

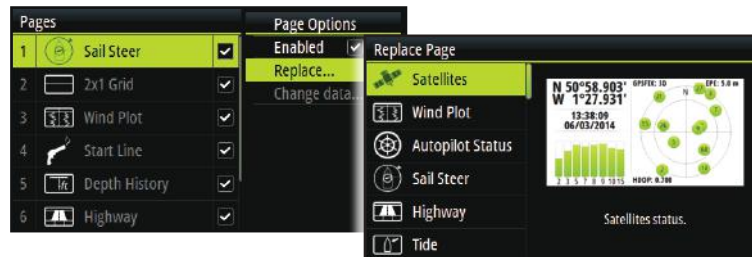

The new chosen page will be shown in the pages list.

Enabling / Disabling a data page

To make a data page available via the **PAGE** key you will need to first ensure it has been selected as one of the eight available pages.

Once the page has been selected as one of the eight data pages you can enable / disable it

- 1 Highlight the required page via the pages menu
 - 2 Press **MENU**
 - 3 Highlight Enabled
 - 4 Press the **ENTER** key to switch the page on or off.
- **Note:** A tick symbol next to the page denotes that the page is active.

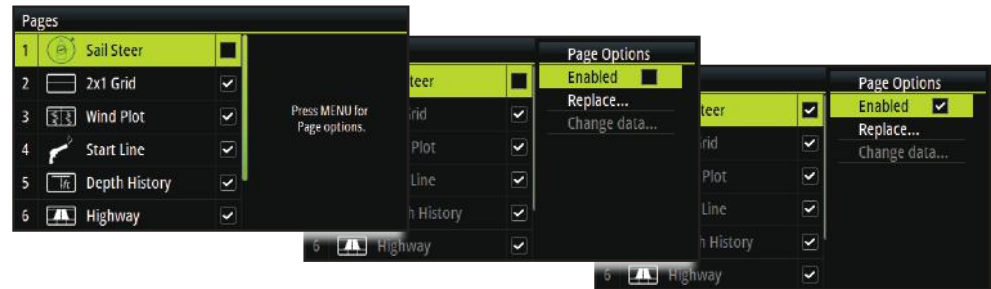

Menus

From a data page a single press of the **MENU** key will open the **Page menu** for that specific page. A double press of the **MENU** key will open up the **Settings menu**.



Page menu

The **Page menu** options vary from page to page. All Page menus have a race timer and settings option to access the **Settings menu**. All other options listed will relate directly to the current data page.

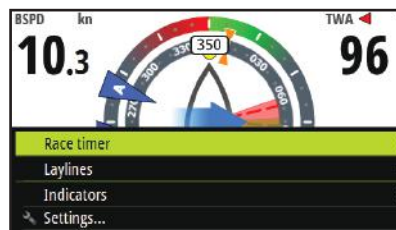

Settings menu

The **Settings menu** is where display options, display and system settings and calibration can be accessed.



Example menu structure

- 1 Select a menu as above.
 - 2 Use the **UP/DOWN** and **ENTER** keys to navigate through the menu options.
- **Note:** Whilst navigating a menu a single press of the **PAGE** key will return to the previous menu option.

Example below: How to access the Time dialog via the Settings menu.

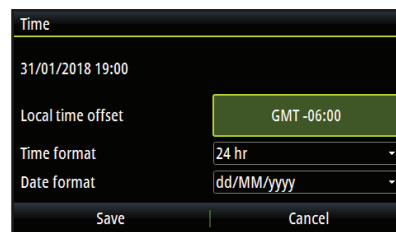
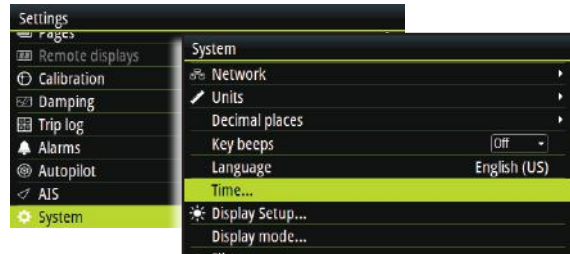

Race timer



The race timer can be used to countdown to zero from a specified time, ideal for counting down to a race start. It can also be used to count up from zero to record the elapsed time. The timer can be started at any time by selecting Start Timer from the timer setup menu. If the start value is set to zero (00:00) when the timer is started the timer will begin counting up, recording the elapsed time.

- **Note:** The timer is shared between all displays on the network. All timer values are synchronized.



- **Note:** The timer set value is in Hours : Minutes (hh:mm), the timer counter will show Minutes : Seconds (mm:ss) with the hours shown in the top right hand corner of the display.

Countdown timer

To count down to a race start, a time value can be set in the Set start value field in the Race Timer setup menu.

Set start value

- 1 Select the Start Time field.
- 2 Use the **UP & DOWN** keys to set the desired number
- 3 Press the **ENTER** key to move to each consecutive number.
- 4 Press the **PAGE** key to exit the number edit field.

5 Once complete select OK to confirm.

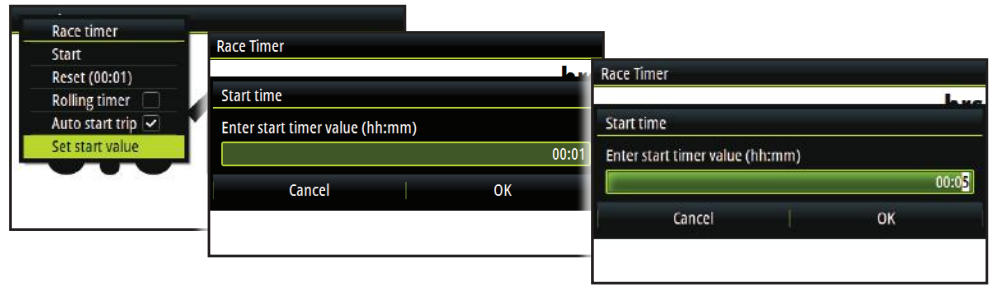

→ **Note:** Selecting Cancel or navigating away using the **PAGE** key will lose any changed settings.

When a time is present in the start value field the timer will begin to count down from that number when the timer is started. Once the time reaches zero it will begin counting up recording the elapsed time.

Start/Stop timer

To start the timer, select Start in the Race Timer menu. When the timer is started it will return to the previous data page. To stop the timer from counting select Stop in the Race Timer menu.



Sync

When the timer is counting down selecting Sync will synchronize the time up or down to the nearest full minute.

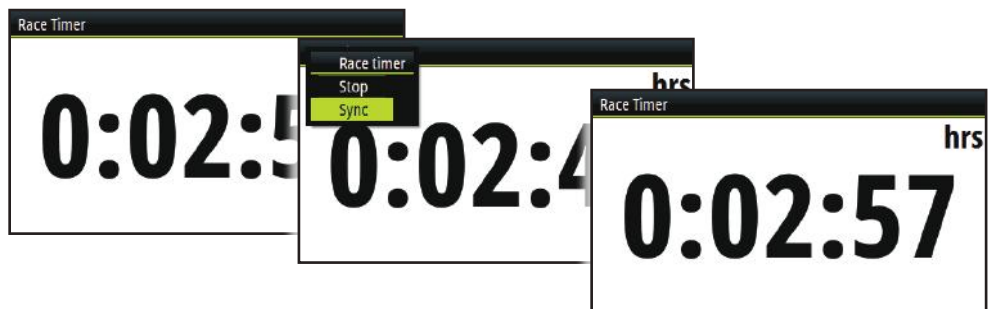

Reset

Selecting Reset will reset the timer to the start value. If the timer was running, it will continue to run from the start value.

Rolling timer

Selecting Rolling timer will restart the countdown timer every time it reaches zero. It will continue to do this until the timer is stopped.

Auto start trip

Selecting Auto trip start will enable the Trip Log to record your time and mileage from the moment the countdown timer begins counting up from zero.

Man Over Board

If an emergency situation should occur and a man over board event is triggered, the display automatically switches to the MOB screen.

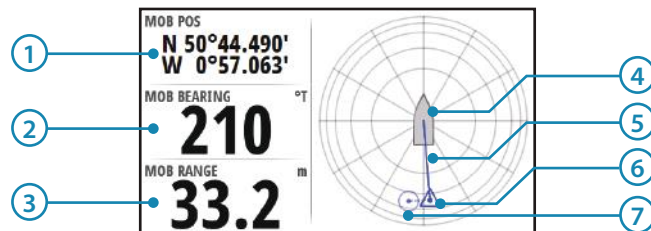

Displayed data

No.	Description	No.	Description
1	Last known MOB position	5	Direction to MOB from vessel
2	Bearing to MOB	6	Dead reckoned MOB position
3	Range to MOB	7	Last known MOB position
4	Vessel (Always points up)		

- A waypoint becomes active at the position the man over board is activated. This is indicated with a circular symbol. If the man over board event is activated via an AIS-SART then this position will update via the AIS-SART signal.
- The GPS longitude and latitude co-ordinates of the last known position are shown in the top left of the screen with the bearing and range MOB waypoint data listed below.
- If you have an H5000 CPU on the network the CPU will perform dead reckoning calculations to provide the estimated position of the man over board. This position will be displayed as a triangle symbol.

	Vessel
	Last known MOB position (H5000 CPU or MFD required)
	Dead reckoned MOB position (H5000 CPU required)

→ **Note:** To cancel the man over board event press **MENU** and select cancel.

AIS

If a compatible AIS system or an NMEA 2000 VHF that can do AIS (Automatic Identification System) is connected to the network, then any targets detected by these devices can be displayed on the AIS page. You can also see messages and position from SARTs and AtoNs within the defined range.

The AIS page

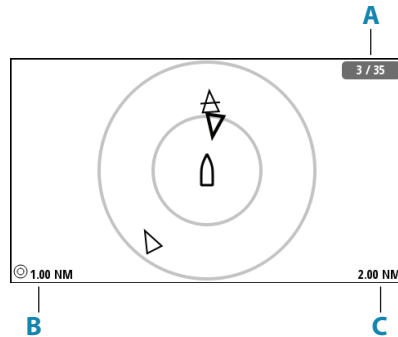

The AIS page shows:

- own vessel in the center of the page
- AIS targets within set range
- number of displayed icons versus total number of targets (**A**)
- distance between range rings (**B**)
- selected range (**C**)

AIS target symbols

The system uses the AIS target symbols shown below:

	Sleeping AIS target (not moving or at anchor).
	Moving and safe AIS target with course extension line.
	Dangerous AIS target, illustrated with bold line. A target is defined as dangerous based on the CPA and TCPA settings. Refer to "Defining dangerous vessels" on page
	Lost AIS target. When no signals have been received within a time limit, a target is defined as lost. The target symbol represents the last valid position of the target before the reception of data was lost.
	Selected AIS target, activated by selecting a target symbol. The target returns to the default target symbol when the cursor is removed from the symbol.
	AIS SART (AIS Search And Rescue Transmitter).

Selecting a target

You use the arrow keys to select individual AIS targets on the AIS page. When selected the target symbol change to a selected AIS target symbol.

AIS page display options

The following options are available for displaying the AIS targets:

Range

Defines the display range on the AIS page. Selected range is indicated in the lower right corner of the AIS page.

Icon filters

By default, all targets within the selected range are shown on the AIS page. You can select to hide safe AIS vessels, and to not show targets based on vessel speed.

Extension lines

Defines the length of course over ground and heading extension lines for your own vessel and for other vessels.

The length of the extension lines is set to indicate the distance the vessel will move in the selected time period.

Your own vessel heading information is read from the active heading sensor, and COG information is received from the active GPS. For other vessels COG data is included in the message received from the AIS system.

Displaying target information

Displaying information for a single target

When a target is selected, you press the **Enter** key to display detailed information about the selected target.

Target list

The Target list displays basic information for all received AIS targets.



Name	Distance Bearing	EPA TCRA	Type Status
2320722	19.7 NM	11.6	AIS safe
2320829	14.8 NM	0.28	AIS safe
AVON	1.27 NM	181	AIS safe
BAREFOOT	2.05 NM	0.13:49	AIS safe
BLUE VOYAGER	1.04 NM	0.24	AIS safe
	3.05 NM	0.05:54	AIS safe
	2.81 NM	0.02	AIS safe
	3.07 NM	0.15:38	AIS safe
	1.82 NM	0.96	AIS

By pressing the **MENU** key you can sort the target list by the different information. You can also select to include all targets or only dangerous targets in the list.

AIS messages

Receiving a message

A message received from an AIS vessel will immediately be displayed on any page if the Vessel message is turned on in the Alarm settings dialog. Refer to "Vessel alarms" on page 34.

List of all AIS messages

All received messages are listed in the Message listing, activated by pressing the MENU key when the AIS page is displayed.

Select a message and press the MENU key to display the original message.

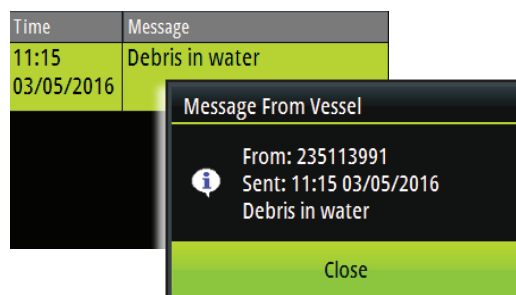

Calling an AIS vessel

If the system includes a VHF radio supporting DSC (Digital Select Calling) calls over NMEA 2000, you can initiate a DSC call to other vessels from the graphic display.

From the Call dialog you can change channel or cancel the call. The Call dialog is closed when the connection is established.

AIS SART

When an AIS SART (Search and Rescue beacon) is activated, it starts transmitting its position and identification data. This data is received by your AIS device.

If your AIS receiver is not compliant with AIS SART, it interprets the received AIS SART data as a signal from a standard AIS transmitter. An icon is positioned on the AIS page, but this icon is an AIS vessel icon. If your AIS receiver is compliant with AIS SART, the following takes place when AIS SART data is received:

- An AIS SART icon is located on the page in the position received from the AIS SART
 - An alarm message is displayed if you have enabled the siren, the alarm message is followed by an audible alarm.
- **Note:** The icon is green if the received AIS SART data is a test and not an active message.

Vessel alarms

You can define several alarms to alert you if a target shows up within predefined range limits, or if a previously identified target is lost.

The alarms are activated from the Alarm Settings dialog.

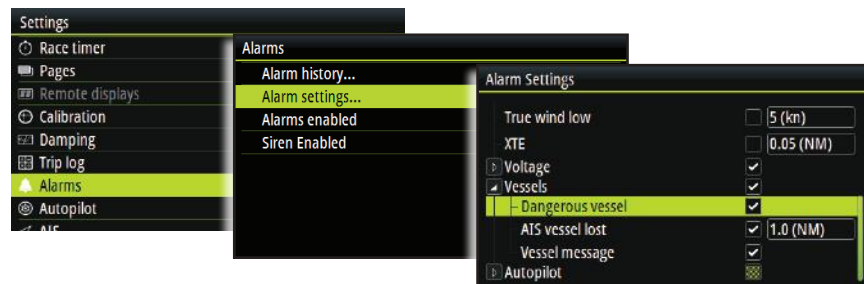

For more information about alarms, refer to “Alarms” on page 36.

Dangerous vessel

Controls whether an alarm will be activated when a vessel comes closer than the distance for CPA within the time limit for TCPA. Refer to “Defining dangerous vessels” on page 35.

AIS vessel lost

Sets the range for lost vessels. If a vessel is lost within the set range, an alarm occurs.

- **Note:** The check box controls whether the alarm pop-up box is displayed and if the siren goes on. The CPA and TCPA define when a vessel is dangerous regardless of the enabled or disabled state.

Vessel message

Controls whether an alarm will be activated when a message is received from an AIS target.

AIS settings

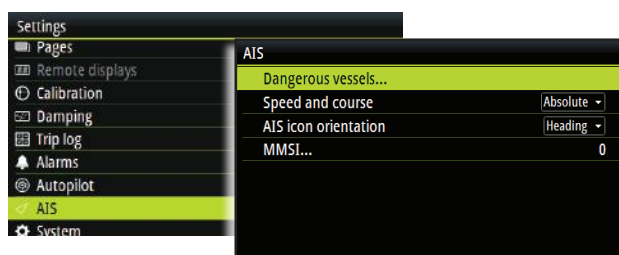

Defining dangerous vessels

You can define an invisible guard zone around your vessel. When a target comes within the set limits, the symbol changes to the Dangerous target symbol. An alarm is triggered if activated in the Alarm settings panel.



Speed and course indication

The extension line can be used to indicate speed and course for targets, either as absolute (true) motion or relative to your vessel.

AIS icon orientation

Sets the orientation of the AIS icon, either based on heading or COG information.

Your vessel's MMSI number

Used for entering your own MMSI (Maritime Mobile Service Identity) number into the system. You need to have this number entered to receive addressed messages from AIS and DSC vessels.

HV display support

Any compatible B&G HV display e.g. 20/20 HV mast display connected to the network can be configured via the H5000 CPU webserver, Graphic Display or Race Display to show desired data e.g. speed, depth, wind speed.

→ **Note:** When a new HV display is added to the network the default data displayed will be boat speed. If no boat speed data source is available the display will show the word 'OFF'

Remote displays

The remote display page can be accessed from the **Settings menu**. Here all HV Displays will be listed by size. Any displays that are not present on the network will be greyed out.

To change what data is shown on a HV display, highlight the display in this menu, press the **ENTER** key and select the required data type from those listed.

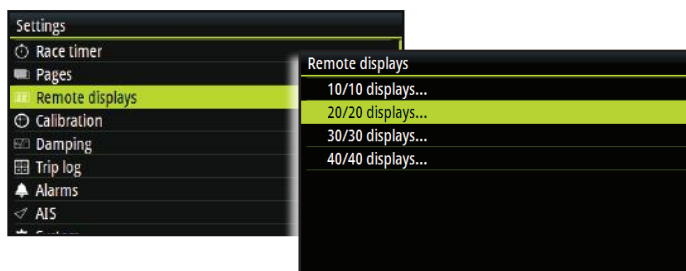

Configuring an HV display

From the remote display menu, select the HV display that you wish to configure.

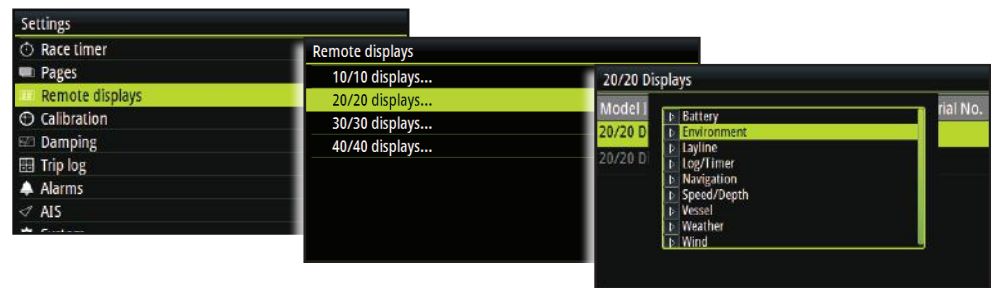

Select the information source you wish to show on the selected HV display.



Once selected the screen will revert to the remote display page.

Alarms

If you have the relevant sensor connected to the network you can enable that alarm by selecting it/them from the alarm list.

Alarm on / off

Turn an alarm on or off from the alarm list. A tick symbol next to the alarm in the alarm list will indicate that the alarm is on.

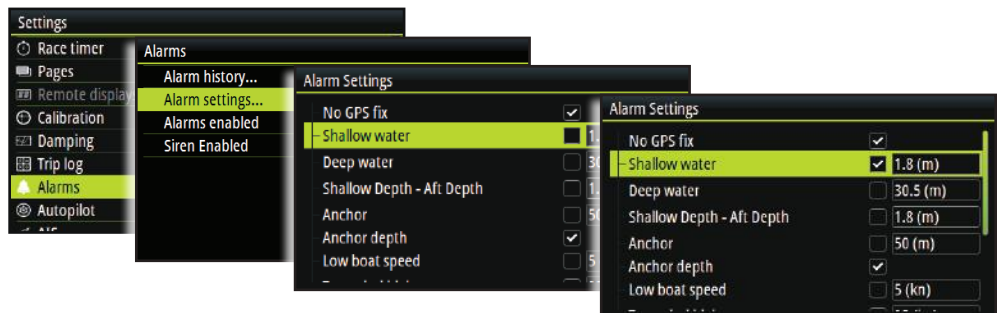

→ **Note:** It is possible to enable / disable all alarms by selecting the 'Alarms Enabled' field from the Alarms menu.

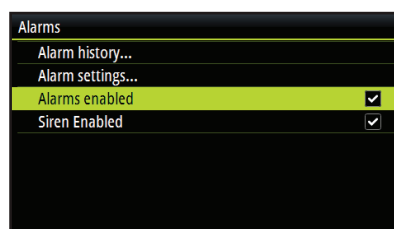

Alarm settings

- 1 Press **MENU** on an alarm that requires parameters to be set will take you to the Enabled / Set limit menu.
- 2 Select Set limit
- 3 Set the required alarm parameter
- 4 Press the **PAGE** key once you have finished editing
- 5 Select OK to confirm.



Alarm indication

The alarm system is activated if any alarm settings are exceeded. Alarms are indicated with an alarm text and with an audible alarm (optional).



- ➔ **Note:** See Alarm settings for further details on how to set an alarm. If an autopilot is not on the network, autopilot alarms will not be accessible.

If no specific alarm text is available, an alarm code will appear.

Acknowledging an alarm

An alarm is acknowledged by pressing the **ENTER** key. This will remove the alarm notification, and silence the alarm from all units that belongs to the same alarm group. A reminder will reappear at given intervals for as long as the alarm condition exists.

- ➔ **Note:** An alarm received from non B&G units on the network must be acknowledged on the unit generating the alarm.

Alarm history

The alarm history can be accessed via the Alarm history menu. This stores alarm messages until they are manually cleared.

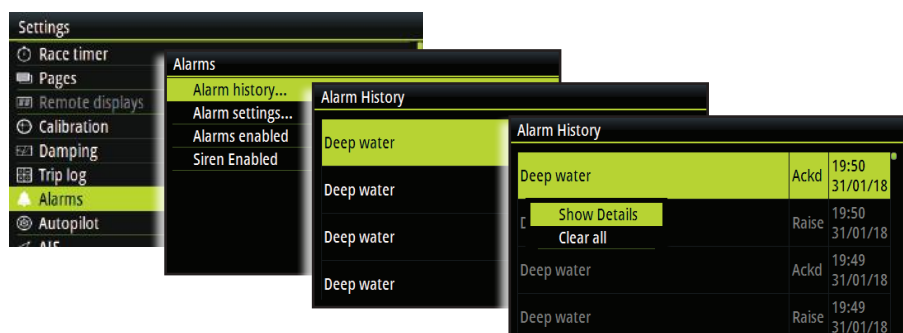

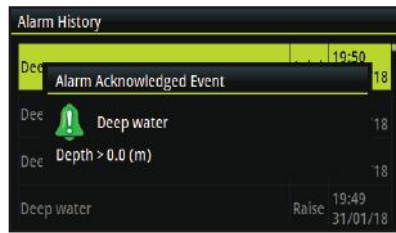

Clear alarm history

To clear the alarm history list, select 'Clear All' from the Alarm history menu.

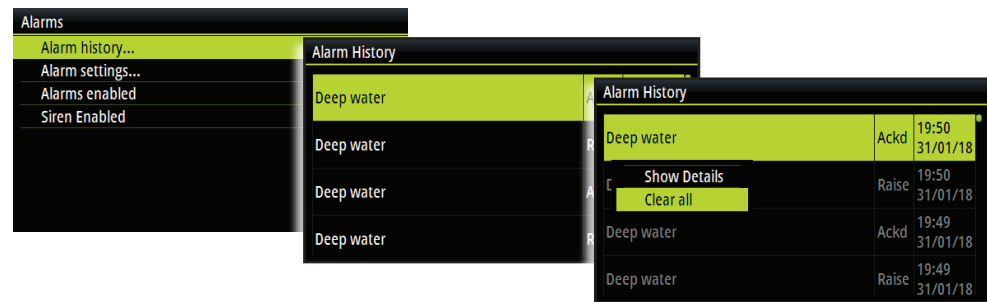

Damping

The damping rate affects the frequency that the sensor data is updated, the greater the damping value the smoother the number change will be but the slower the response will be to data change.



Damping parameters

Below is a list of parameters that a damping value can be applied to. Set the damping value (response rate) for each parameter from 0 to 9 seconds.

- Heading
- Apparent wind (angle & speed)
- True wind speed*
- True wind direction*
- Boat speed
- Speed Over Ground (SOG)
- Course Over Ground (COG)
- Heel angle
- Trim angle
- Dynamic boat speed (Bspd) Hercules & Performance only!*
- Tide

→ **Note:** * only available if a H5000 CPU is connected.

Dynamic boat speed

With Dynamic Damping the damping value applied to boat speed will reduce to almost zero during conditions when the data is changing rapidly.

The boat speed damping value is set (in seconds) to a steady state value, the Dynamic Damping is set to a value between 0 (off) and 9 (maximum), the higher the value, the more sensitive the boat speed is to rates of change and the quicker the damping value is lowered. This allows the effects of the change to be more readily seen on the instruments. As the rate of change of the function reduces, so the damping value is allowed to rise to the preset damping value.

- **Note:** Damping should not be confused with the update rate, which is the number of times per second that the function value is sent to the display. The update rate is fixed for all the functions.

Trip log

There are two recorded trip logs. Trip log 1 records distance traveled through the water, trip log 2 records distance traveled via GPS input.

- **Note:** Trip log 2 requires a compatible GPS connected to the network.



No.	Description	No.	Description
1	Trip distance	3	Trip time
2	Average speed	4	Maximum speed

- **Note:** Correctly calibrated boat speed is essential for accurate trip records.



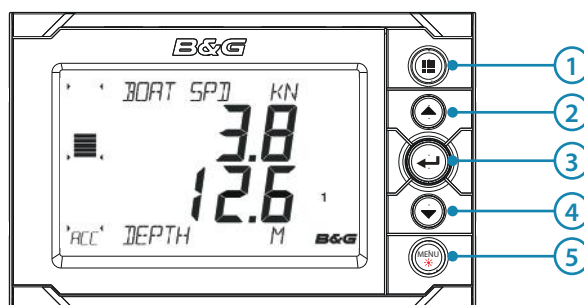

Log

Shows total miles run from installation. This is based on distance over the water.

Race display



Basic operation

- 
1 PAGE
 Each press of the **PAGE** key scrolls through the data pages in rotation or navigates back to the display pages from within any menu. Press and hold the **PAGE** key to save the current page configuration.
- 
2 UP
 Selects the upper half of the display to change variables; scrolls through menus and variables; increases / decreases values.
- 
3 ENTER
 Used to enter the selected sub menus and confirm selections.
- 
4 DOWN
 Selects the lower half of the display to change variables; scrolls through menus and variables; increases / decreases values.
- 
5 MENU / LIGHTS
 Used to enter the **Settings menu** and scroll through the menu options. Long press enters the lights settings page.

Display information

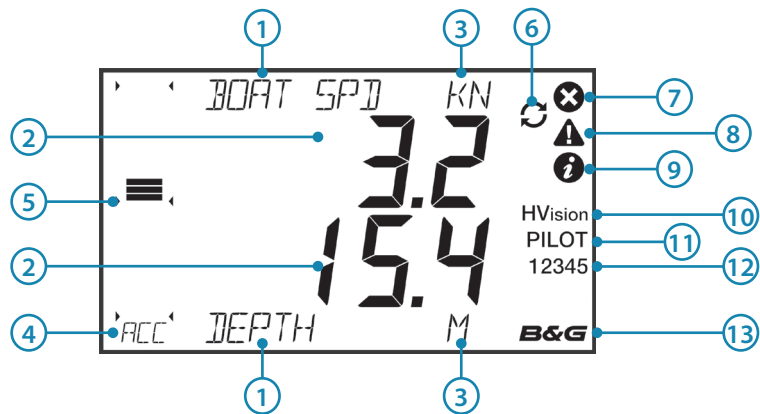

No.	Description	No.	Description
1	Data variable name	8	Alarm - Warning
2	Display data value	9	Alarm - Info
3	Units of measure	10	Controlling remote (HV) Displays
4	Bargraph data type	11	Autopilot engaged
5	Bargraph data	12	Active page number
6	Page stored / Source select	13	B&G H5000 CPU on the network
7	Alarm - Critical		

Menus

To enter the menu function press the **MENU** key. To operate a menu use the **UP** and **DOWN** directional keys and press the **ENTER** key to select a menu item. Press the **PAGE** key to navigate back to the display pages.

Pages

The display shows five configurable data pages. Data pages show a variety of data and information available from sensors and devices on the network.

- **Note:** All of the default pages can be edited to show the users preferred boat data. Each press of the **PAGE** key will change the current data page to the next page in the cycle.
- **Note:** Pressing the **PAGE** key will change the data pages in sequence and in continuous rotation from pages 1 to 5.

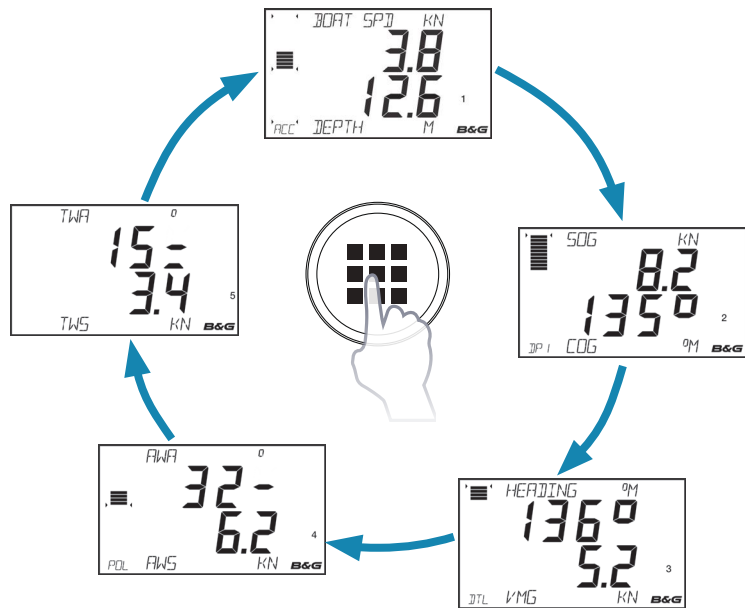

Edit data page contents

You can edit any of the five data pages so that they display the specific boat data that you require.

Page data editing

Select the page you wish to edit. Press the **UP** key to select the top data field or the **DOWN** key to select the bottom data field.

Once selected the chosen data field text will flash to indicate the menu has been selected.

Using the **UP** and **DOWN** keys choose the required data type required, once selected press the **ENTER** key. The field text will stop flashing and return to the data page. A long press of the **PAGE** key will save the display configuration.

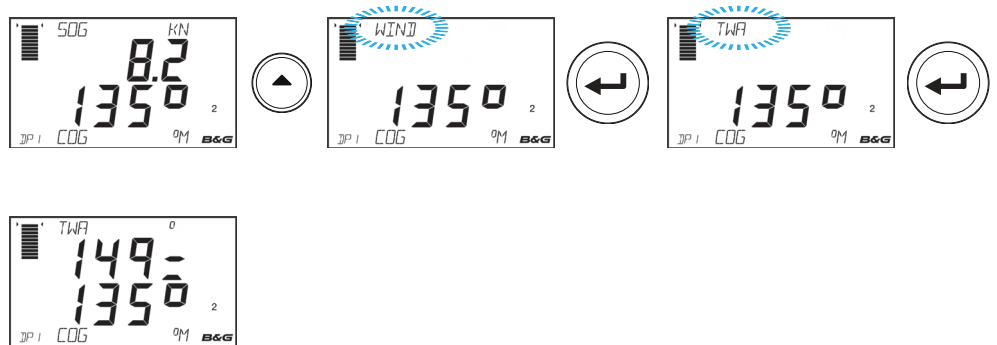

Bargraph data editing

Select Bargraph menu option, use the arrow keys to select the required bargraph variable. Press the **PAGE** key to save the change and return to the data page screen.

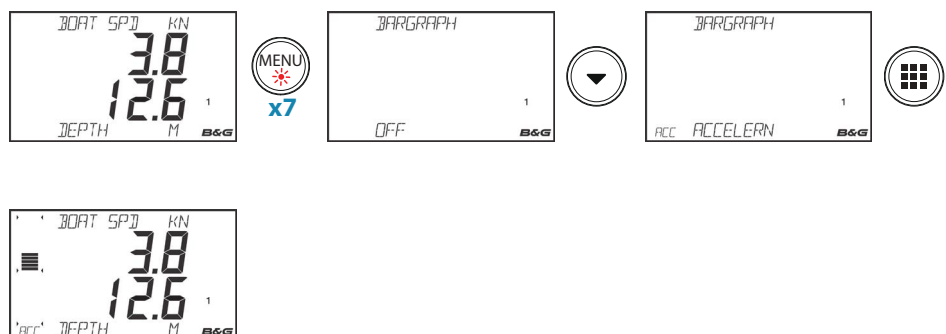

Race timer

The race timer can be used to countdown to zero from a specified time, ideal for counting down to a race start. It can also be used to count up from zero to record the elapsed time.

- **Note:** Once the countdown timer reaches zero it will start counting up showing the elapsed time from zero. The timer will continue to count until it is stopped.

Set

Sets the value of the timer.



Once set is selected, use the directional keys to set the required time.

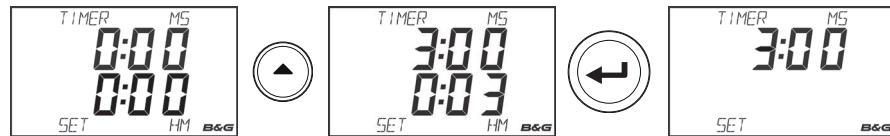

- **Note:** The timer can only be set to whole minutes.

Start

Starts the timer. If a time value is preset the timer will countdown. If the timer is on zero it will count up.



Synchronize

Synchronizing the timer will cause the timer to reset to the nearest whole minute.

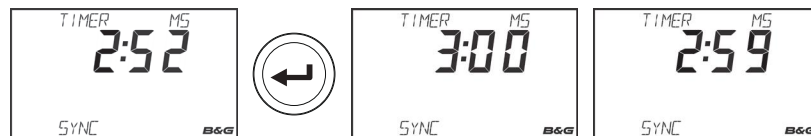

Stop

Stops the timer. Press the **ENTER** key again to restart the timer.

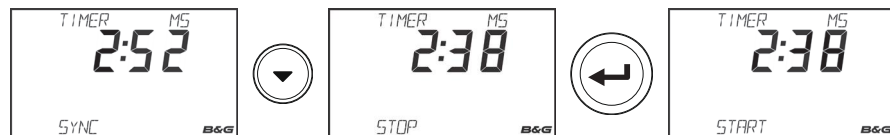

Reset

If the timer is running, selecting reset will automatically start counting down from the originally set value for the race timer. If the timer is stopped when reset is selected it will set the clock to the originally set value and will not begin the countdown until start is selected.



Remote displays

Remote displays can be individually set via the race display to show a single variable.

Configuring remote display data

Select the remote menu, then select the remote display (e.g. 20/20 HV) you wish to configure.

→ **Note:** The remote display will flash on and off to indicate it has been selected for editing by the race display.

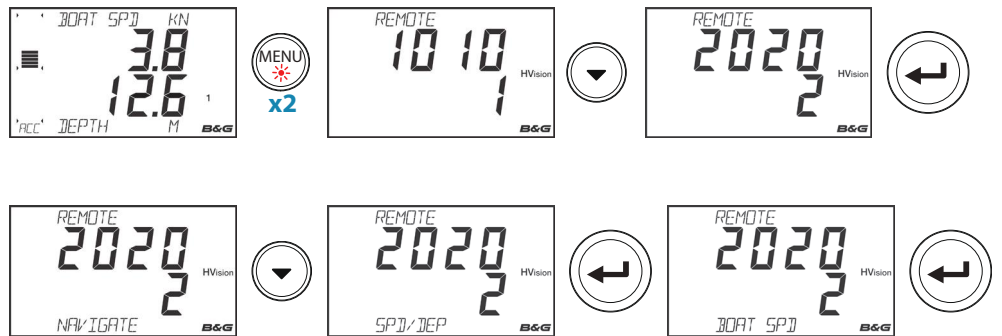

Use the **UP/DOWN** and **ENTER** keys to navigate to a variable and select the variable to display. Exit by pressing the **PAGE** key.

Lighting zone selection

Set the lighting zone on the display. All units in the selected lighting zone will mirror each others light settings. Default setting is network.



→ **Note:** Press and hold the **MENU / LIGHTS** key to get to the Lighting menu.

Backlighting

Set the desired lighting level on the display.

→ **Note:** All units in the selected lighting zone will mirror each others light settings. Default setting is network. To change the lighting zone select the lighting menu and press **DOWN** the lighting zone type will flash. Select the desired zone and press the **ENTER** key.

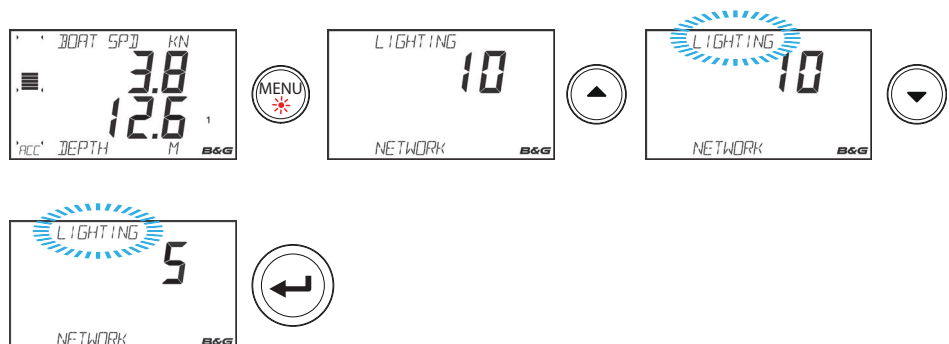

Trip log

There are two recorded trip logs. Trip log 1 records distance traveled through the water, trip log 2 records distance traveled via GPS input.

→ **Note:** Trip log 2 requires a compatible GPS connected to the network.

Start trip log



Stop trip log



Reset trip log



Alarms

When alarms are set to 'On' the race display will show alarm messages when predefined alarm parameters on the network are triggered. When the race display alarm is set to off, no alarm message will be displayed on the race display.



Alarm notification

When an alarm event is received the display will change to show the variable name that is alarming and the current value. An icon will be highlighted to indicate the severity of the alarm.

Alarm icons

There are three alarm icons for the three levels of alarm severity as shown below.

	Important / Critical
	Warning
	Information

Depth alarm example



Acknowledging an alarm

An alarm is acknowledged by pressing the **ENTER** key twice in quick succession. This will remove the alarm notification (text, light and sound) from all units on the network. A reminder will reappear at given intervals for as long as the alarm condition exists.



Diagnostics

The diagnostic pages show details of the display, instance number, software version, LCD test and reset options. To access the diagnostic pages, press and hold the **MENU** key when you power on the display. Use the **UP/DOWN** keys to scroll through the pages.

Version

Software version number. Check the B&G website for the current available software version.

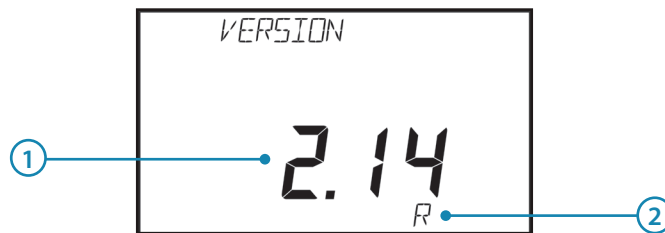

No.	Description	No.	Description
1	Software version number	2	R = Indicates released version. Any other identification is used for internal testing only

Checksum

Additional version information in hexadecimal format. This information is for B&G support only.

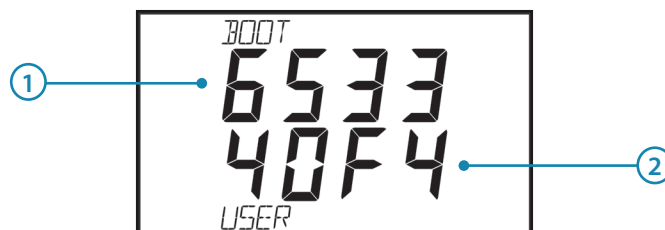

No.	Description	No.	Description
1	Boot code	2	User code

Full reset

Factory reset of the display. All settings will revert to factory default. Select the full reset page, press the **ENTER** key and a full reset will take place and return the display back to the default speed and depth page.



User reset

Resets page configuration to their default settings. All other settings will remain unchanged. Select user reset, press the **ENTER** key. The display will show complete once finished.

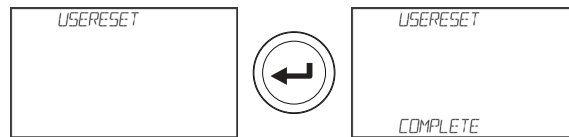

LCD segment test

When the LCD segment test page is selected the display will automatically begin the LCD test. This is a visual test that needs to be performed by the user. Each segment will switch on in sequence until all segments are lit. It is the responsibility of the user to visually spot any faulty / missing LCD segments.

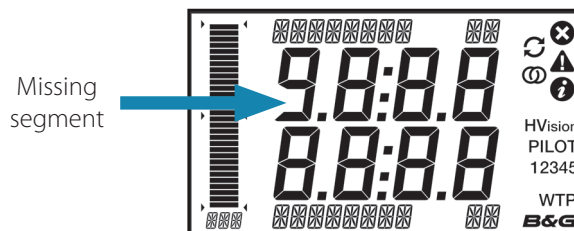
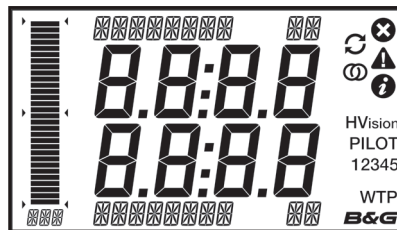

Lights test

Select the lights page. Press the **ENTER** key, the display will go through each of the light settings in sequence. It is the responsibility of the user to visually check the light levels.

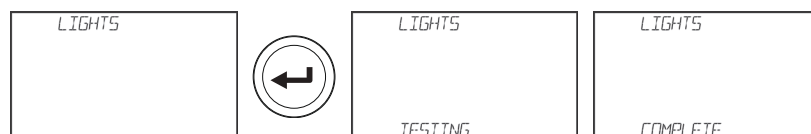

Instance

The display instance is a number that can be set as a reference for the user to distinguish between different displays. By default the display instance is set to zero.

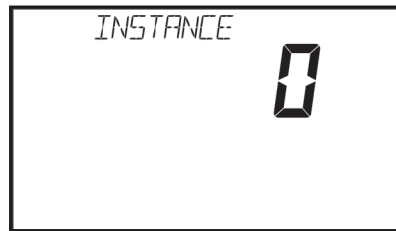

Voltage

Shows the current voltage supply to the display.



H5000 Pilot Controller

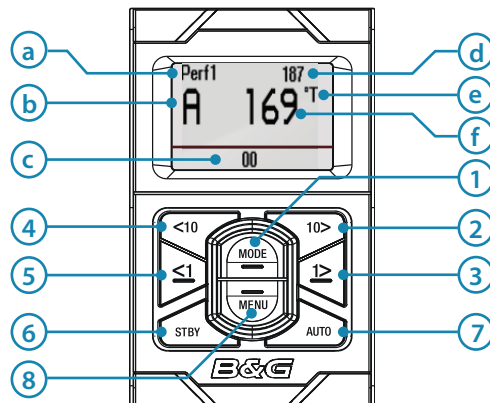

Display

The displayed information will change depending which mode is selected.

<i>X</i>	Description	<i>X</i>	Description
a	Performance level	d	Target
b	Autopilot mode	e	Compass: °T = True °M = Magnetic
c	Rudder angle indicator	f	Heading

Keys

The H5000 Pilot Controller is operated by 8 keys. These are used to operate the autopilot and adjust autopilot parameters.

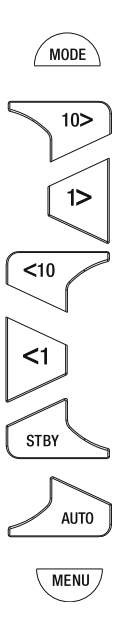
- 
- 1 MODE**
Changes the autopilot mode / Scrolls up in menu options / Increases values. With active autopilot: Toggles between Wind mode and Auto mode
 - 2 10° COURSE CONTROL STARBOARD (10° RIGHT)**
Changes target course 10° Starboard
 - 3 1° COURSE CONTROL STARBOARD (1° RIGHT)**
Changes target course 1° Starboard / Activates Non Follow Up (NFU) mode when in Standby mode / Enter menu
 - 4 10° COURSE CONTROL PORT (10° LEFT)**
Changes target course 10° Port
 - 5 1° COURSE CONTROL PORT (1° LEFT)**
Changes target course 1° Port / Activates Non Follow Up (NFU) mode when in Standby mode / Exit menu
 - 6 STBY**
Disengages the autopilot
 - 7 AUTO**
Engages the autopilot
 - 8 MENU**
Enter the **Main menu** / Scrolls down in the menu options / Decreases values. Press and hold for 3 secs enters the lighting settings.

⚠ Warning: The installation settings must be performed as part of the commissioning of the autopilot system. Failure to do so correctly may prohibit the autopilot from functioning properly! The Installation menu can only be accessed in Standby mode.

Setup

Adjust the display settings, enable the alarm buzzer, change the language, key beeps and enable advanced mode.



Display

Day mode

Day is the default display mode. The following parameters can be manually adjusted.

- Red backlight
- Inverse display
- Contrast

Night mode

Change the display to night mode color pallet. Lighting adjustments can be made as per the day mode settings. All displays in the selected lighting zone will also change to night mode.

Lighting group

Set the lighting group on the display. All units in the selected lighting group will mirror each others light settings. Default setting is Network.



Light level adjustment

Press the **MENU** key for 3 seconds to access the backlight level screen. The **MODE** key will increase the brightness level, the **MENU** key will decrease the brightness.

→ **Note:** Brightness level (1-10). The light level selection times out after 2 seconds.

Alarm buzzer

Enable / disable the H5000 Pilot Controller alarm buzzer.

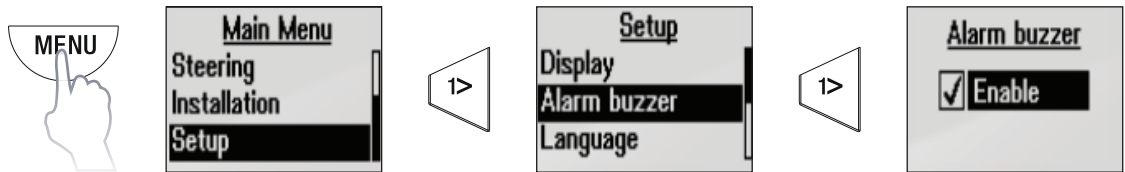

Language

Set the desired language

Local

- Reset the H5000 Pilot Controller settings without resetting the autopilot. This will return the H5000 Pilot Controller to its default sound and light settings
- Advanced settings menu - Enable / Disable

Key beeps

Enable / disable H5000 Pilot Controller key beeps

Software info

- H5000 Pilot Controller serial number
- Software version
- Software release date

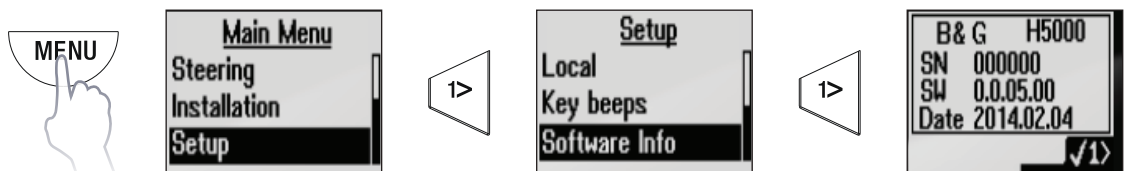

→ **Note:** For autopilot operation see "Autopilot" on page 66.

5

Sensor calibration

Once the display is setup and before you proceed with calibration ensure all network sources are selected and configured as shown in section 6.

Calibration example:

Depth

A typical transducer installation is through the hull in front of the keel. A datum (offset value) can be set, such that the depth display refers to either the water line or the base of the keel.

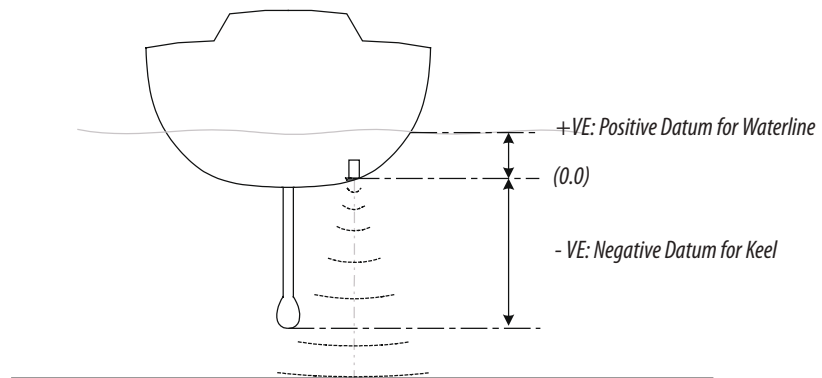

Setting the depth offset displays depth readings from directly below the keel or propellers of the boat, or from the waterline to the seabed. This makes it easier to see the available depth, taking into account the draught of the boat.

The offset value to be entered should represent the distance between the face of the depth transducer, and the lowest part of the boat below the waterline, or the distance between the face of the depth transducer and the water surface.

Depth offset value

- 1 Enter the **Settings menu**.
- 2 Select depth via the calibration menu.
- 3 Select Offset.

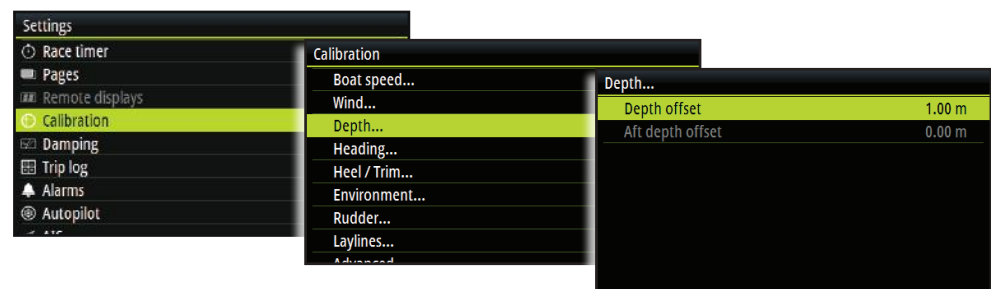

- 4 A dialog box will appear showing the current depth offset value.

→ **Note:** The default value is zero

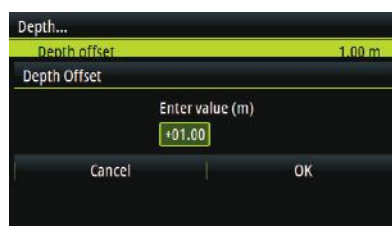

Setting a calibration value

- 1 Highlight the value field.
- 2 Press the **MENU** key to enable editing of the calibration value. The cursor will flash in the value field.
- 3 Use the **UP/DOWN** Keys to adjust the value or toggle between plus and minus (+ / -).
- 4 Press the **ENTER** key to move to the next number in sequence. The current number will flash when selected.
- 5 Press the **ENTER** key when the last digit is highlighted in the calibration field to exit.
- 6 Select OK.
- 7 Press **ENTER** to confirm and exit. The offset will then be set to the desired value and the display will return to the calibration page.



- **Note:** If the calibration offset value fails an error message will appear “Setting offset failed”. Check sensor connection and source selection and retry.
- **Note:** The same statement applies for Aft Depth.

Boat speed

Speed calibration is necessary to compensate for hull shape and paddlewheel location on your boat. For accurate speed and log readings, it is essential that the paddlewheel is calibrated. Boat speed values can be shown in knots, kph or mph. Your preferred unit of measurement can be set in the units page of the setup menu.

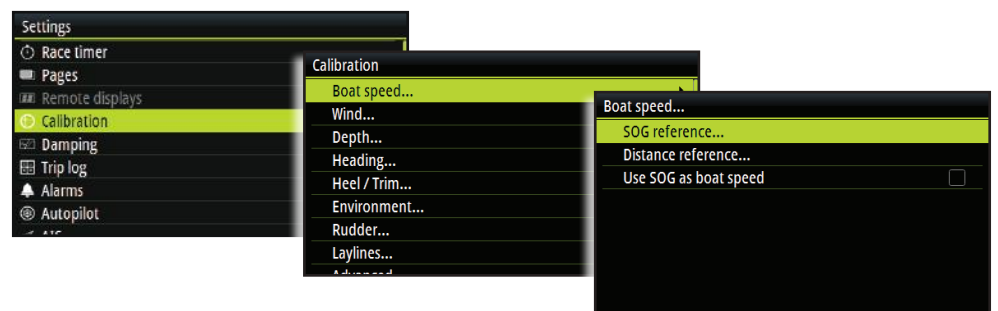

Auto - Calibration via reference to GPS SOG value

This is an AutoCal facility that uses speed over ground (SOG) from your GPS and compares the average of SOG against the average boat speed from the speed sensor for the duration of the calibration run.

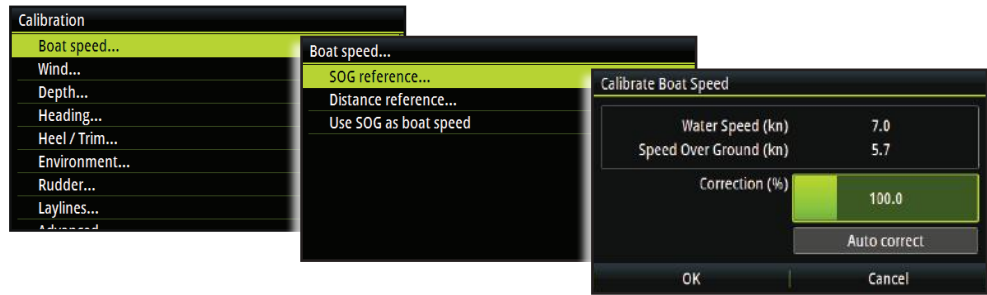

→ **Note:** This calibration should be made in calm sea with no effect from wind or tidal current.

- 1 Bring the boat up to cruising speed (above 5 knots)
- 2 Select Auto correct on the Calibrate boat speed page
- 3 When the calibration is completed the Boat speed calibration scale will show the adjusted percentage value of the boat speed.
- 4 Select OK once complete to confirm correction and exit.

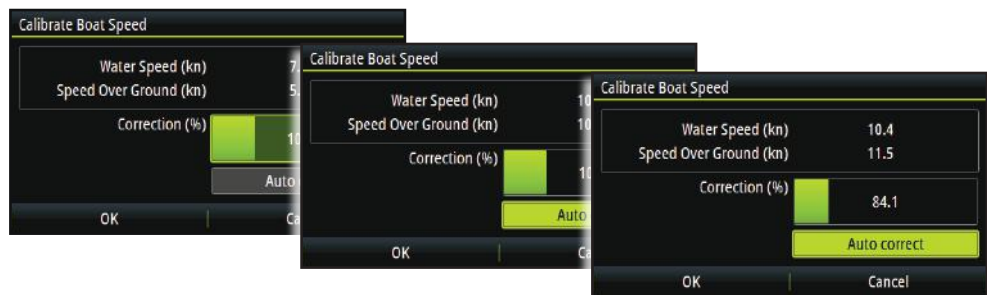

Manual adjustment of boat speed

Adjust the boat speed manually by selecting the Boat speed percentage slider. Adjust the percentage up or down as desired via the calibrate boat speed page. Confirm the value. Select OK once complete.

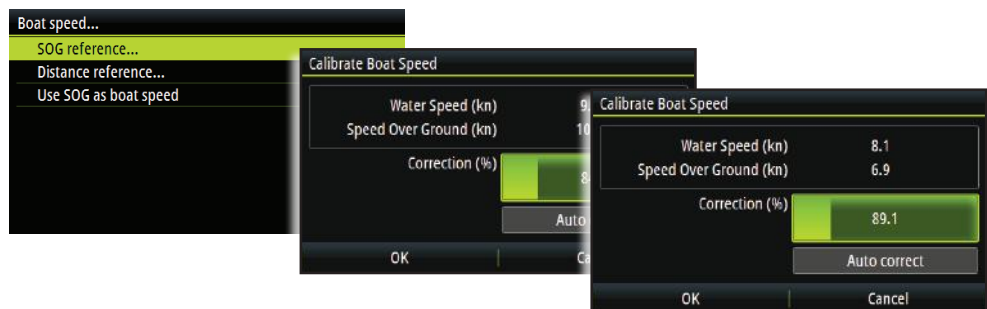

Distance reference

This facility enables the user to calibrate the log accurately and simply. Calculations are performed by the display that works out the boat speed over a known distance.

To calibrate the boat speed via a distance reference you will need to complete consecutive runs, under power at a constant speed made along a given course and distance.

- **Note:** To eliminate the effect of tidal conditions it is advisable to perform at least two runs, preferably three, along the measured course.

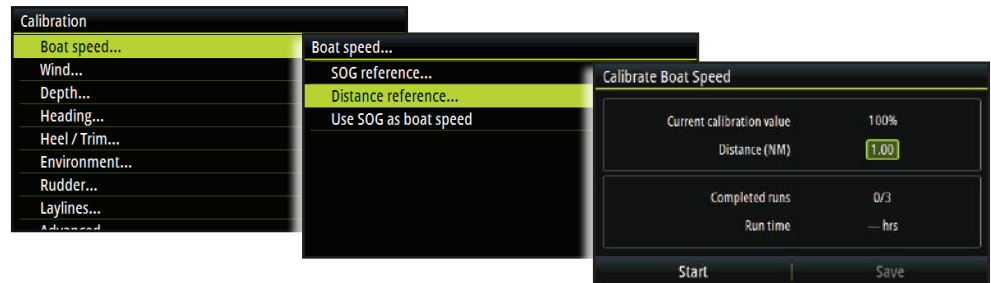

How To Calibrate boat speed via Distance Reference

- 1 Enter the desired distance in nautical miles that you would like to calculate the distance reference over.
- 2 When the boat gets to the predetermined starting position of the distance reference calculation start the calibration timer.
- 3 As the boat passes marks A and B on each run, instruct the system to start (Start Run) and stop (Stop Run) and finally OK to end calibration (End Cal Runs).
- 4 After the last run is completed and OK has been selected, Select save to store the calibration.
- 5 A pop up warning will ask you if you wish to replace the current calibration with the new one. Select Yes to complete or cancel to not replace the calibration value.

Distance reference diagram

Referring to the diagram, A and B are the markers for each run and X is the actual distance for each run as measured from a suitable chart.

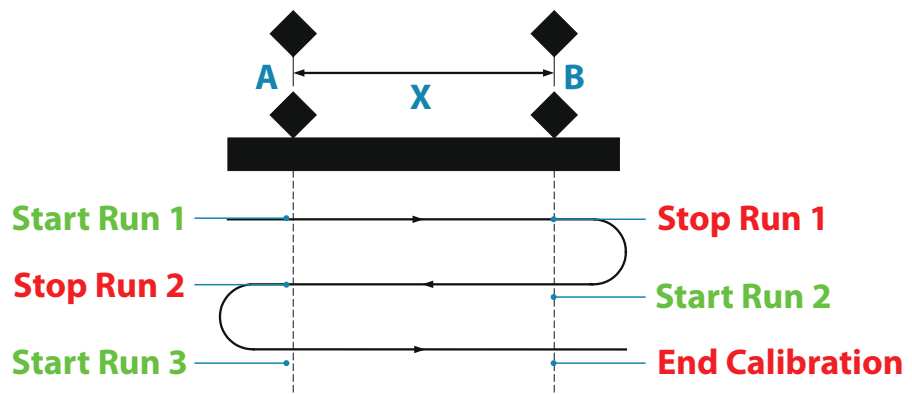

- **Note:** It is important to maintain the same constant boat speed over each run.

Use SOG as boat speed

If boat speed is not available from a paddle wheel sensor it is possible to use speed over ground from a GPS. SOG will be used in the true wind calculations.

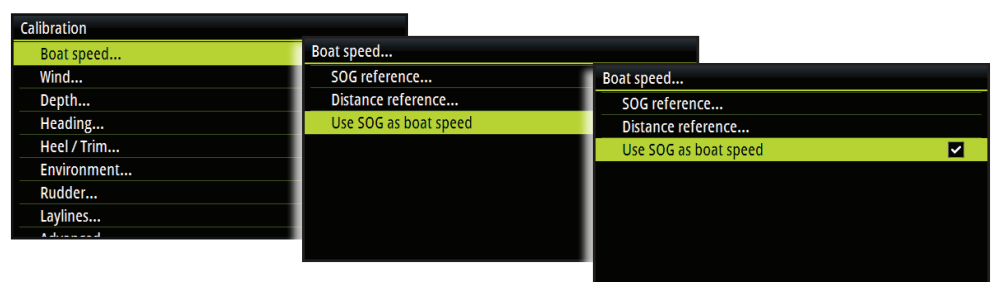

Dual boat speed calibration

When using dual boat speed sensors (port & starboard) calibrate each sensor individually by selecting Port or Starboard boat speed from the calibration menu.

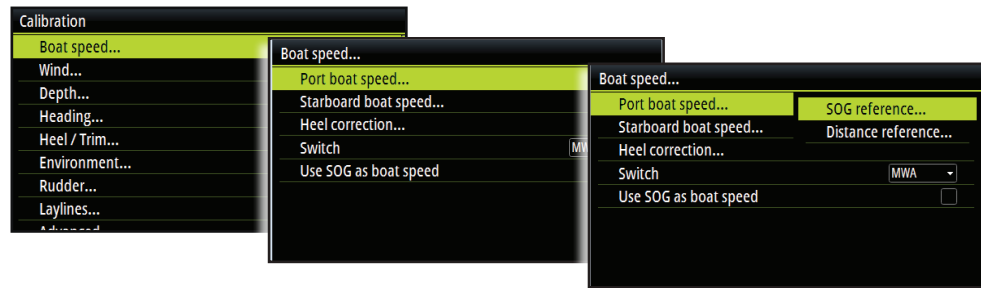

- **Note:** To enable dual sensors, see Dual sensor support / Measured sources for more information.
- **Note:** These options can be set via the H5000 Calibration menu on a compatible B&G Multi Function Display (MFD)

Heel correction



Edit the heel correction table to improve the accuracy of boat speed data when the boat is heeled over.



- **Note:** These options can be set via the H5000 Calibration menu on a compatible B&G Multi Function Display (MFD)
- **Note:** Advanced heel correction options are available in the webserver.

Measured sources

Measured sources allows the user to have a two boat speed sources and two wind sensor sources active on the network at the same time. The CPU will automatically switch between them giving more accurate data from tack to tack.

Dual Boat speed

Set the quantity and type of boat speed sensor via the measured sources menu. After setting the number and type of sensor ensure they are calibrated correctly. Follow the standard boat speed calibration procedure for each sensor Port & Starboard.

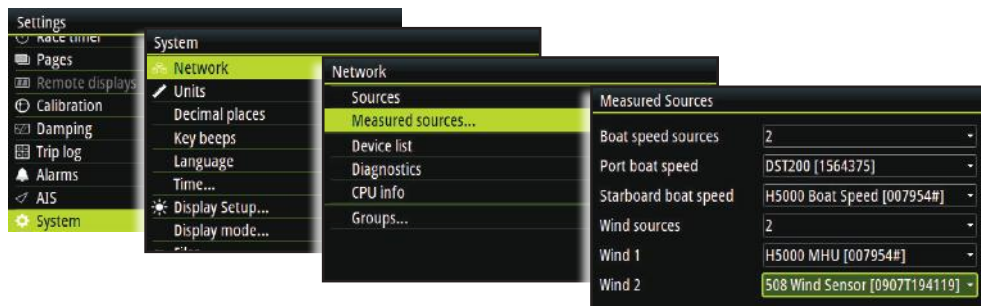

- **Note:** These options can be set via the H5000 Calibration menu on a compatible B&G Multi Function Display (MFD)

Switching between boat speed sensors

The CPU can handle sensor switching in a variety of different ways. Change this setting via the Switch dialog in the boat speed calibration menu.

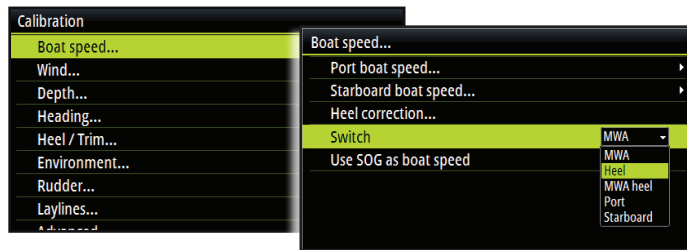

Switch option	Description	
MWA	Uses the Measured Wind Angle (MWA) to determine the current tack	
	Port tack	Use starboard sensor
	Starboard tack	Use port sensor
Heel	Uses the heel of the vessel to determine whether to use the port or starboard sensor. A heel sensor is required for this option	
MWA Heel	If the measured wind angle is less than 90° the CPU will use heel to determine whether to use the port or starboard sensor. If the MWA is greater than 90° the CPU will use the MWA to determine whether to use the port or starboard sensor.	
Port	Port sensor only	
Starboard	Starboard sensor only	

→ **Note:** These options can be set via the H5000 Calibration menu on a compatible B&G Multi Function Display (MFD)

Dual Wind sensor

||| PERFORMANCE |||

Set the quantity and source of wind sensor via the measured sources menu. After setting the number and source of sensor ensure they are calibrated correctly. Follow the standard wind sensor calibration procedure for each sensor.

→ **Note:** These options can be set via the H5000 Calibration menu on a compatible B&G Multi Function Display (MFD)

Switching between wind sensors

The CPU handles sensor switching automatically.

MHU - Wind Sensor	Sensor priority
MHU 1 (Wind sensor 1)	Used when the measured wind angle is less than 90° on MHU 1
MHU 2 (Wind sensor 2)	Used when the measured wind angle is greater than 90° on MHU 1

Environment

Sea / Air Temperature & Barometric pressure

If a suitable sensor is fitted, the system will monitor the current sea / air temperature and barometric pressure.

The offset value to be entered should adjust the reading from the sensor to match a calibrated source, i.e. adjust sea temperature to match reading from a thermometer when submersed in the water.

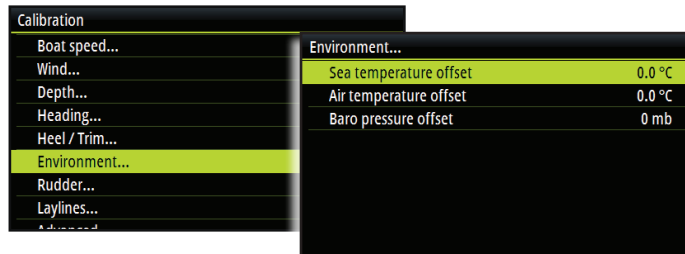

Masthead unit adjustment

This provides an offset calibration in degrees to compensate for any mechanical misalignment between the masthead unit and the center line of the vessel.

To check the masthead unit alignment error we recommend you use the following method which involves a sailing trial.

Sail on a starboard tack on a close hauled course and record the wind angle, then repeat the process on a port tack. Divide the difference between the two recorded numbers and enter this as the wind angle offset.

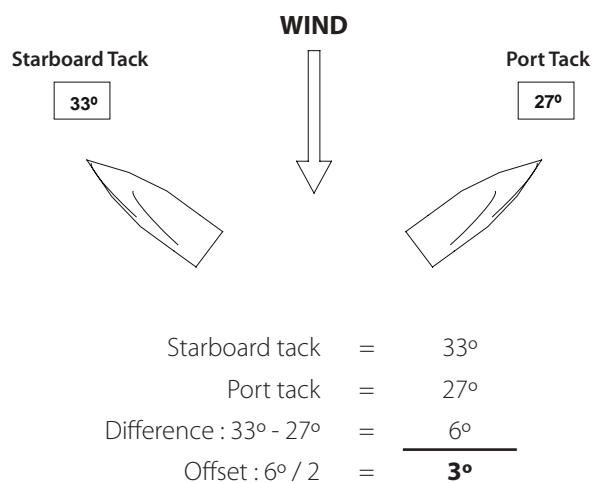

If the starboard apparent wind angle is greater than the port angle then divide the difference by 2 and enter this as a negative offset. If the port angle is greater than the starboard then divide the difference by 2 and enter this as a positive offset.

MHU Align

Once the offset has been calculated enter it into the MHU Align calibration field

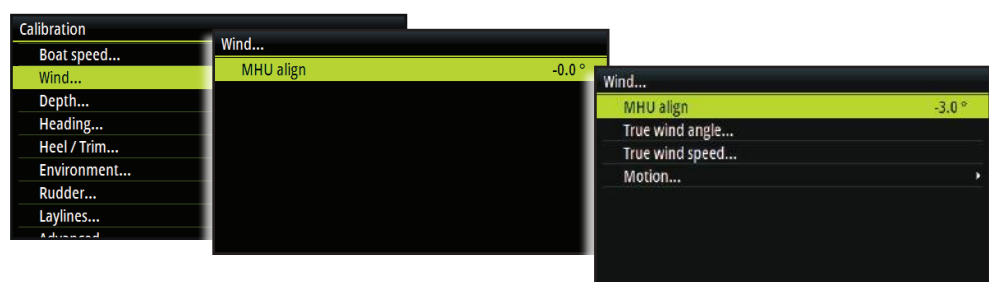

Motion correction

When the wind is measured it is initially corrected for masthead unit alignment offset and mast rotation. Set the mast height and tick Motion Correction for motion correction to be applied to measured wind speed and wind angle.



- **Note:** A 3D Motion sensor and mast height value is required in conjunction with a CPU running Hercules level software or greater to use this feature.

TWA / TWS Correction tables

The TWA and TWS Correction tables receive their information from the H5000 CPU. This information is not stored in the CPU.



- **Note:** TWA / TWS correction tables can also be adjusted from the webserver and the Zeus family MFDs.
- **Note:** Advanced true wind correction options are available in the webserver.

Editing a correction table

- 1 Highlight the field that requires editing and press the **ENTER** key
- 2 Adjust the correction value to the desired number
- 3 Select OK once complete to return to the correction table



True Wind Angle calibration

There are two methods of calibrating TWA, monitoring true wind direction from tack to tack or use the compass to verify the angles the yacht is tacking or gybing through.

Start the TWA calibration process for either method by setting the boat up to do a number of tacks upwind or gybes downwind in as steady conditions as possible.

Method 1 - Monitor True Wind Direction changes

If an error is seen in true wind direction, then the following rule applies:

- If true wind direction is being shown as a lift each time you tack then True Wind Angle is reading too wide, half the error must be subtracted from the TWA correction table.
- If true wind direction is being shown as a header each time you tack then True Wind Angle is reading too narrow, add half the error to the TWA correction table.

Method 2 - Monitor tacking angles

If according to the compass you are tacking through an angle different than the sum of the True Wind Angles on each tack (Port TWA + Starboard TWA) then the following rule applies:

- If the tack angle < the sum of the TWA's, the True Wind Angle is reading too wide, half the error must be subtracted from the TWA correction table.
- If the tack angle > the sum of the TWA's, the True Wind Angle is reading too narrow, add half the error to the TWA correction table.

→ **Note:** Ensure your compass is correctly calibrated before carrying out TWA calibration using either method.

True Wind Speed calibration

True Wind Speed errors are seen from sailing upwind to downwind. This is due to the acceleration of the airflow over the top of the mast and around the sails when sailing downwind. -10% is the default value for TWS calibration. Monitoring the change in True Wind Speed from close hauled to broad reaching will enable further refinement of this calibration value.

→ **Note:** Advanced option to correct TWS at user defined angles upwind, reaching and downwind are available in the MFD and webserver.

Auto Calibration via webserver

It is possible to auto calibrate via the Webserver. See the Webserver help files for more details.

Heading (compass)

Auto Cal

The compass Auto Cal process records the magnetic fields in the yacht that cause deviation errors. It calculates the corrections when the compass calibration is started provided the following conditions are met:

- The 360° turn - For example, RC42 compass or 2 x 360° turn Halcyon Gyro Stabilized compass is completed in the same direction.
- The rate of change of heading does not exceed 3°/s; i.e. the turn should take about 2 minutes to complete.
- The rate of change of heading must not fall below 0.2 °/s during the 360° turn, i.e. the turn must not take longer than 12 minutes.
- The rate of change in heading is reasonably constant.
- The compass is installed in a location a safe distance from magnetic interference such as iron keels, engines, loudspeakers etc.
- Consideration should also be given to electrical cables which may carry high currents (e.g. large motors).
- The compass is installed in a location as close to the centre line of the boat as possible. Avoid areas such as the fore peak and the sides of the hull where the effects of pitch and roll are at their greatest.
- On steel hulled vessels, the compass will need to be installed above decks away from the effects of the hull.

1 Select Auto Cal

2 Select Calibrate

3 Steer the vessel through 360° maintaining a steady rate of turn



Offset

The compass offset compensates for fixed errors (misalignment) between the compass sensor and the direction of the boat.

To accurately enter a compass offset, the boat's heading must be referenced to, for example: a calibrated bowl compass. The offset value will be the difference between the known source and the currently displayed heading. Enter this value as the offset in the compass heading field as a plus or minus number up to 180°

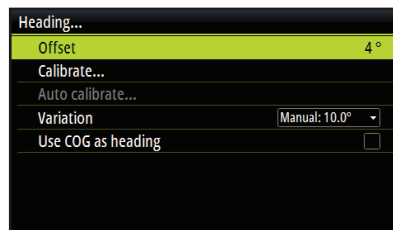
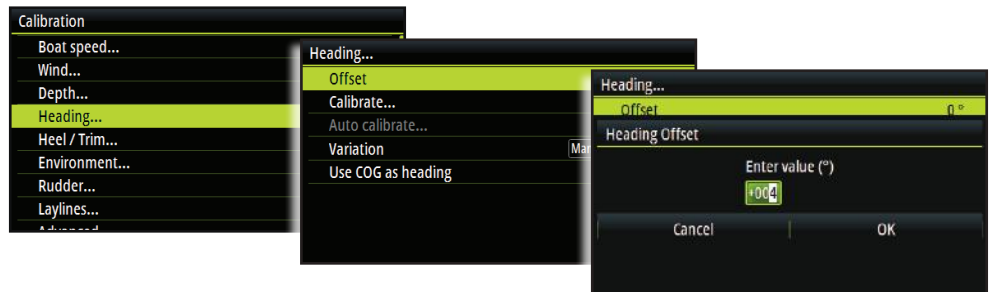

Magnetic variation

Adjust how the system handles magnetic variation.

Auto

Receives variation data from a network source.

Manual

If variation is not available enter a value manually.

Use COG as heading

If heading data is not available from a compass sensor it is possible to use course over ground from a GPS. COG will be used in the true wind calculations.

→ **Note:** The autopilot cannot be operated using COG as the heading source. COG cannot be calculated when stationary.



B&G Multi Function Display (MFD)

H5000 Polar data, measured sources and calibration features can be accessed, modified and updated via a compatible B&G MFD. This data can be found in the H5000 Calibration menu via the tools option on the MFD.



Polars

The H5000 polar tables can be loaded, edited and backed up via a compatible B&G MFD. Access the MFD's Polars menu via the H5000 Calibration menu.

Loading polar tables to an MFD

- 1 Save the polar file to a suitable portable media device (memory card / USB stick) that is compatible with the MFD
- 2 Place the device into the media slot on the MFD
- 3 Find the polar file via the Files folder on the Tools page
- 4 Copy the file from the portable media to the Polars directory
- 5 The new Polar file will now be available via the Polars menu of the H5000 Calibration page



Editing polar tables

- 1 Open the table you wish to edit
 - 2 Select the number and adjust. This is a live update and will change data immediately
- **Note:** TWA Correction table, TWS Correction table, Heel Correction table and measured sources can also be updated via the H5000 Calibration menu on an MFD.



H5000 Calibration options via MFD



Polars



TWA Correction



TWS Correction



Heel Correction



Measured Sources



CPU Info



CPU Settings

6

System setup

From the system menu there are several display and system options as listed in the following section.

- **Note:** The graphic display can do most system settings, however the webserver should be used for more detailed system setup.

Network

Before the system can be used, the data sources need to be configured.

Sources

A data source can be a sensor or a device connected to the network, providing information and commands to other networked devices. The data sources are normally configured at first time turn on. It should only be necessary to update this data if a new source is added, source is missing (sensor failure), source has been enabled/disabled, sensor replaced or a network reset.

Auto select

The Auto select option will look for all sources connected to the instrument system. If more than one source is available for each item, the display will automatically select from the internal device priority list.

- **Note:** Auto select can be performed via a Graphic Display, Webserver or one of the Zeus family of MFDs.

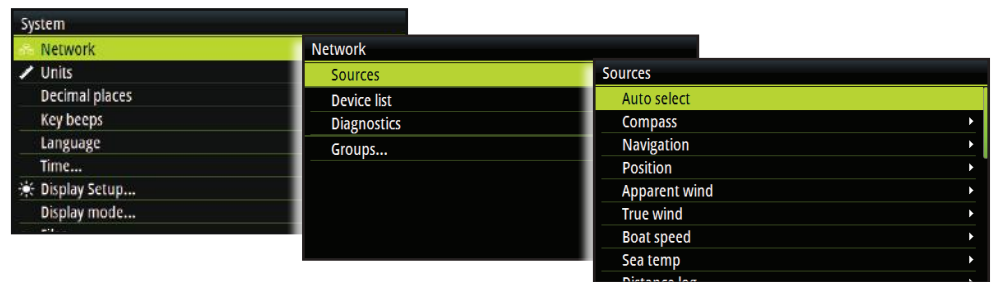

- 1 Verify that all interfaced units are powered on
- 2 Press the **ENTER** key to start the auto select procedure

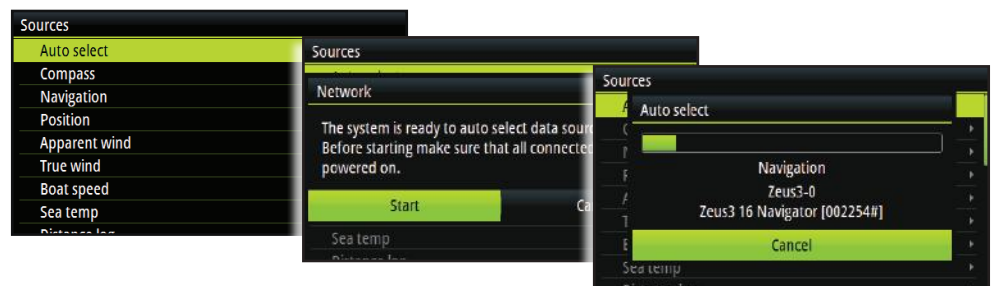

The operator will be informed when the auto select process is completed.

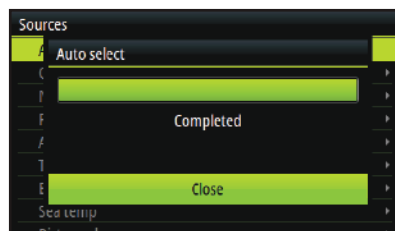

- **Note:** If more than one source is available on the network you can choose your preferred source from the sources menu. See Manual source selection below for more information.

Manual source selection

If more than one source is available for an item, the preferred source may be selected manually. As an example, the following illustrations show how the compass source is changed.



Select the preferred data source. The selected source will be indicated by a tick in the check box.

Device list

Shows a list of all devices connected to the Network.

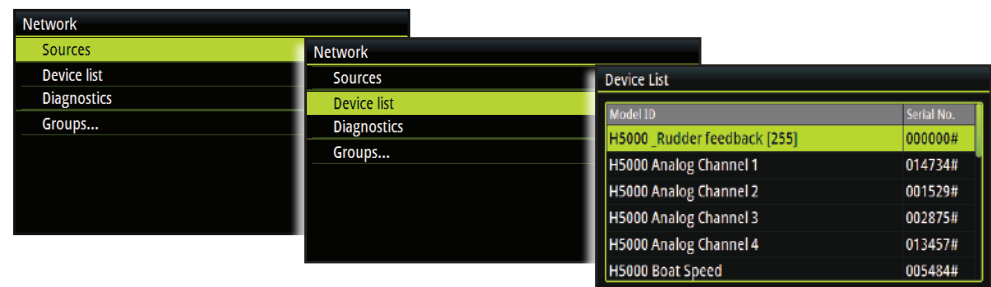

Diagnostics

Diagnostic data on the network.



H5000 CPU info

H5000 CPU software version and IP address.

→ **Note:** IP address is required for Webserver login.

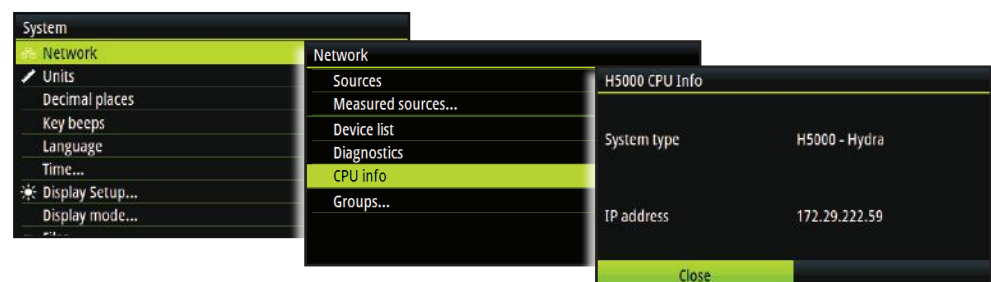

Groups

The group function is used to globally control parameter settings in groups of units. By assigning several units to the same group, a parameter update on one unit will have the same effect on the rest in that group.

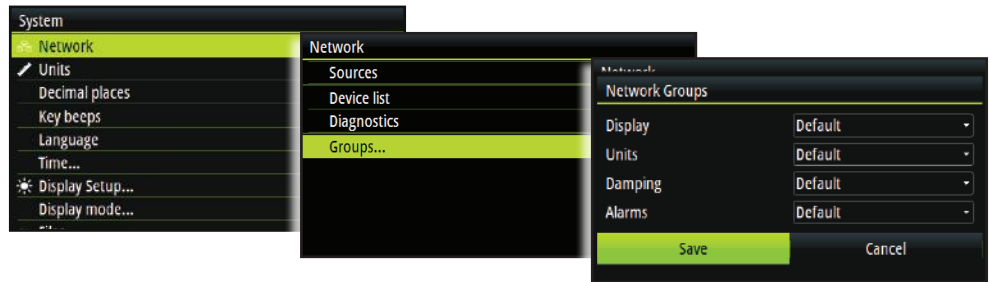

→ **Note:** All groups are shipped from the factory set to 'Default'.

Units

Set the preferred unit of measurement you want data to be displayed in.

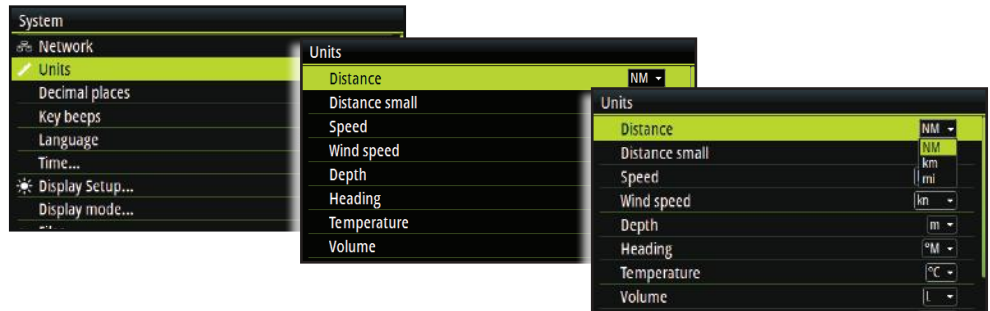

→ **Note:** This can be performed via a Graphic Display, Webserver or one of the Zeus family of MFDs.

Decimal places (boat speed and sea temperature)

Set the number of decimal places that boat speed and sea temperature will be shown in.

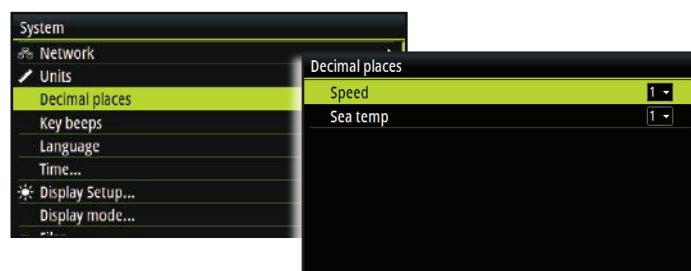

Speed decimal places

Set the decimal places speed will be displayed in. 1 or 2.

Sea Temperature decimal places

Set the decimal places sea temperature will be displayed in. 0 to 2

Language

Set your preferred language for the display.

→ **Note:** This is not a network function. You will need to change all displays separately.

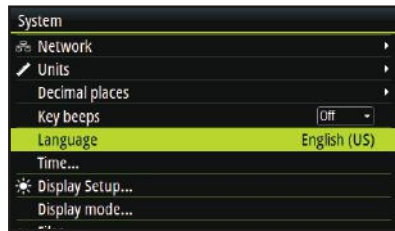

→ **Note:** Once the required language is selected the unit will automatically restart and continue with step 2 of the startup wizard.

Time

From the time menu you can set the preferred time / date format and local time offset. Once complete select Save to save the settings and return to the settings menu.

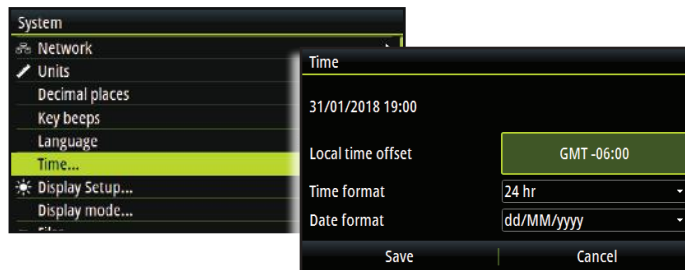

Simulate

Simulator mode sends simulated data to the display.

→ **Note:** All other displays on the network will remain to display the current boat data and will not change to simulate mode.

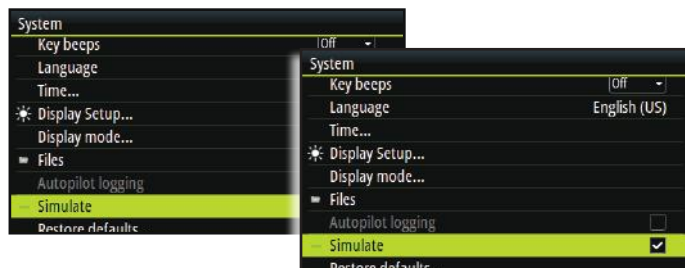

⚠ Warning: It is not advisable to enter simulator mode when using your instrument system as a navigation aid.

Restore defaults

Restore Defaults has the option to wipe all settings or partial settings out of the Graphic Display. Select the data from the list that you wish to delete.

- **Note:** This is not a network function. This will only reset and delete history on the display that 'Restore defaults' is selected on.

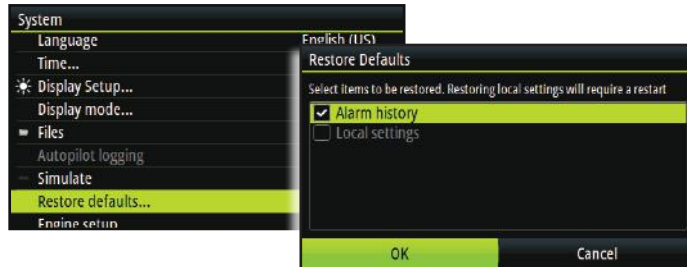

Global reset

The global reset will reset all settings in all displays along with performing a network reset removing all source selection.

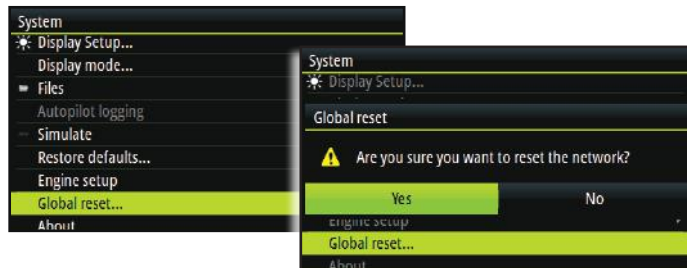

- **Note:** After performing a global reset the Graphic Display will ask to do an auto source selection. A global reset will reset all system modules and devices back to default settings and will need to be re-configured before use.

About

Shows the device information and software version currently installed on the display. Press the **ENTER** key to navigate back to the menu



7

Autopilot

If an H5000 autopilot computer is connected to the network as per the instructions in the H5000 installation manual then the pilot can be controlled from either a H5000 Pilot controller or Zeus / Vulcan MFD.

→ **Note:** See installation manual for the H5000 autopilot setup and commissioning.

Autopilot operation

Turning the autopilot on / off

Engaging the autopilot

At anytime while the autopilot is disengaged press the **AUTO** key to engage the autopilot. The autopilot will steer the boat on the current selected heading.

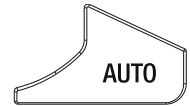

Disengaging the autopilot

At any time the autopilot is engaged press the **STBY** key to disengage the autopilot. The autopilot will go into Standby mode and you will be required to take manual control of the helm.

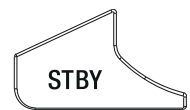

⚠ Warning: In Standby mode pressing either of the 1° directional keys will engage the autopilot in Non Follow Up mode!

Menu navigation

Single press of the **MENU** key will open the **Main menu**.





→ **Note:** Whilst navigating the menu system If no selection is made after 10 seconds the screen will revert to the autopilot status screen



Key	Action
	1° RIGHT Opens highlighted menu option
	1° LEFT Return to previous menu - Continued presses will return the display to the navigation screen.
	MODE Scroll up
	MENU Scroll down

→ **Note:** At anytime a single press of the **STBY** key will exit the menu and switch the autopilot to Standby mode!

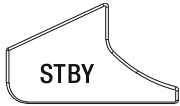
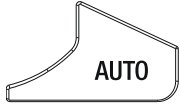
Autopilot modes

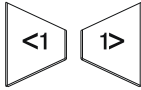
The current heading and Set heading information will change on the display depending on which mode the autopilot is in. Below is a list of the autopilot modes, autopilot mode symbol and the current/target data that will be displayed.

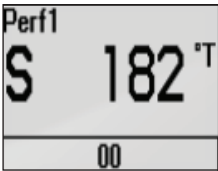
	Mode	Symbol	Description	Required Input
	Standby	S	Passive mode used when manually steering the boat at the helm	
	Auto	A	Keeps the boat on set heading Cancels a turn and continues on the heading read from the compass. Press the MODE key to enter Wind mode. Press MODE key again to revert to Auto mode	Heading
	Wind	W	Steers the boat to maintain the set wind angle. Press MODE key to enter to Auto mode. Press MODE key again to revert to Wind mode	Heading, Speed, True Wind Angle
Press & Hold 3 sec +  to enter mode menu then select required mode	NoDrift	ND	Steers the vessel on a straight bearing line by compensating for drift	Heading, Position
	Navigation	N	Steers the boat to a specific waypoint location, or along a route	Heading, Speed, Position, Waypoint, Route information (MFD)
	Non Follow Up	NFU		Steer the boat manually using the H5000 Pilot Controller

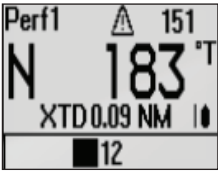
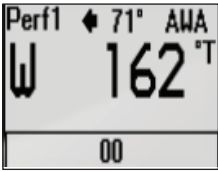
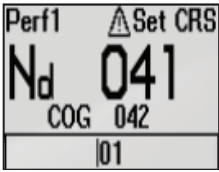
Standby	NFU	AUTO
		
<ul style="list-style-type: none"> • Heading (True or Magnetic) • Rudder angle 		<ul style="list-style-type: none"> • Set heading • Heading
NAV	WIND	NoDrift
		
<ul style="list-style-type: none"> • Bearing to next waypoint • Cross track distance (XTD), analog and graphical 	<ul style="list-style-type: none"> • Set wind angle • Heading 	<ul style="list-style-type: none"> • Set course • Course Over Ground (COG)

Mode selection

From Standby mode, press the **AUTO** key once to enter Auto mode. Whilst in Auto mode a single press of the **MODE** key will set the autopilot to Wind mode. Press the **MODE** key again to revert to Auto mode.



To access other autopilot modes press and hold the **MODE** key for 2 seconds. Highlight the required mode and press the **1° RIGHT** key to confirm.

- **Note:** The mode selection menu will time out after a few seconds. Whichever mode is highlighted at this time will be selected.

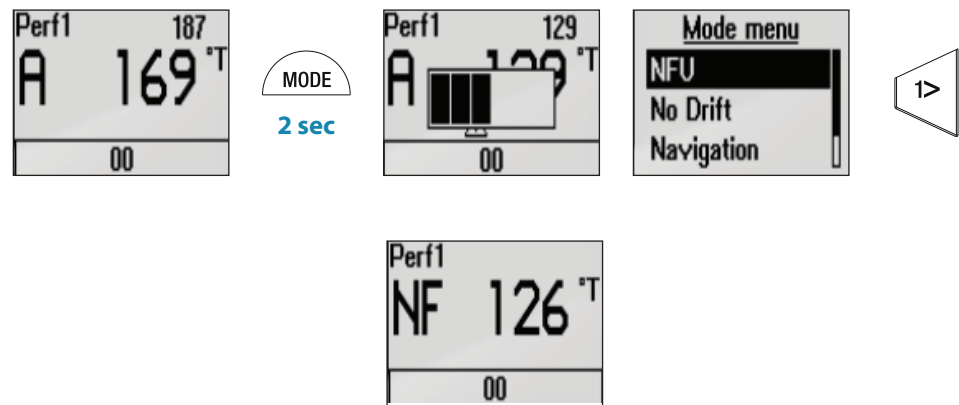

Non Follow Up mode

Whilst in Standby mode, pressing any of the **1° LEFT / RIGHT** keys will move the rudder to your desired angle and change the autopilot mode to Non Follow Up.

Non Follow Up mode allows you to control the rudder position manually via the autopilot controller.

- **Note:** The autopilot will remain in Non Follow Up mode until it is disengaged by pressing the **STBY** key or a new mode is selected.

Tacking & Gybing in Wind mode

Tacking & Gybing in Wind mode can be performed when sailing with apparent or true wind as the reference; in either case the True Wind Angle must be less than 90 degrees (tacking) and more than 120° (gybing).

The tacking/gybing operation will mirror the set wind angle on the opposite tack and a tack confirmation window will appear on the display.

To tack or gybe in wind mode press both **1° COURSE CONTROL** keys on the H5000 Pilot Controller simultaneously. Hold them down until the confirmation window appears. Press **1° RIGHT** to confirm, **1° LEFT** to cancel.

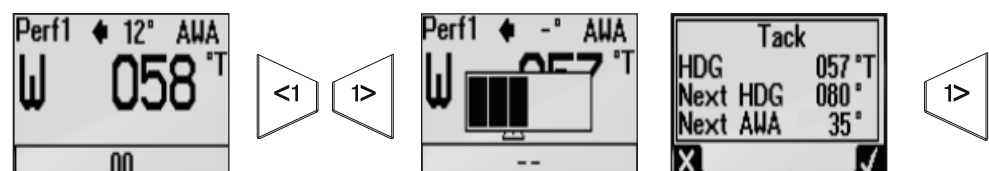

The rate of turn during the tack/gybe is set by the Tack time parameter in the Setup/Sailing menu. The tack/gybe time is also related to the speed of the boat to prevent excessive loss of speed during a tack.

- **Note:** The autopilot will temporarily add a 5 degree bear-away on the new tack to allow the boat to pick up speed. After a short period the wind angle will return to the set angle. If neither tack/gybe or cancel is selected the tack/gybe pop up will close after 10 seconds and the requested tack/gybe will not be initiated.

Tacking & Gybing in Auto mode

To tack in Auto mode press and hold the Port **10 & 1° COURSE** Keys to set a tack to Port and the Starboard **10 & 1° COURSE** keys to set a tack to Starboard.

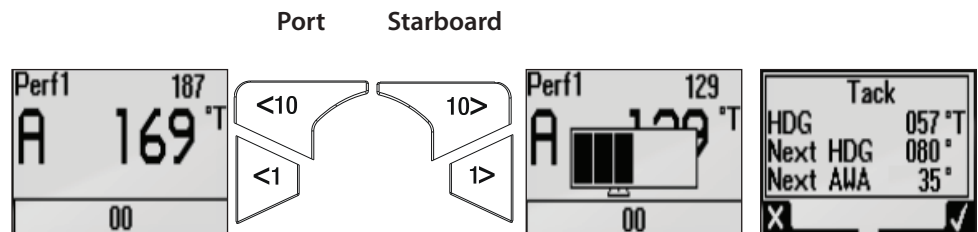

The rate of turn during the tack/gybe is set by the Tack time parameter in the Setup/Sailing menu. The change in heading is controlled by the tack angle parameter in the Setup/Sailing menu.

- **Note:** Default tack angle setting is 100 degrees.

Response

The Response Mode controls the response of the autopilot steering. There are five levels of performance response modes. Level one consumes the least amount of power when steering the autopilot and offers the slowest response. Level five consumes the most power and has the highest response.

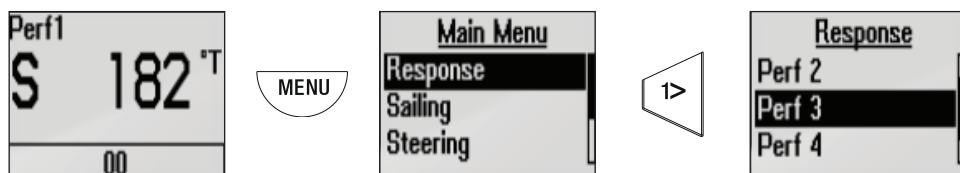

Sailing

The sailing specific autopilot features are only available if advanced is enabled in the local menu.



Once enabled the sailing autopilot features can be accessed via the **Main menu**.

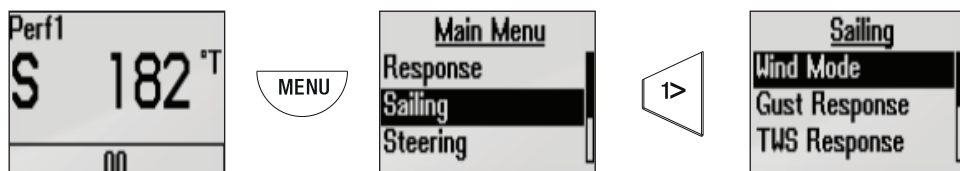

Wind mode

Select what wind function the autopilot will use when in wind mode.

- Auto - In auto if the AWA is $\leq 60^\circ$ Wind mode will use apparent wind. $>61^\circ$ Wind mode will use TWA (True).
- Apparent
- True
- Polar

→ **Note:** The current selection will be highlighted when you enter the menu.

Gust response

Effects how the autopilot will react to rapid changes in heel angle caused by gusts.

To activate this feature select 'Enable'

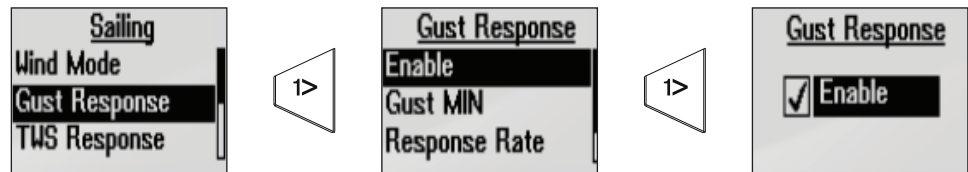

Gust response settings

- Gust Min** Minimum gust in knots before gust compensation is applied.
- Response rate** How aggressively the autopilot will react to gusts.
- TWA response** Controls the size of the window in which gust response will operate.

TWS response (True Wind Speed)

True Wind Speed response is used to compensate for long term changes in wind speed. If the average wind speed increases and stays high, the boat will bear away accordingly, and remain low to the wind until the wind decreases.

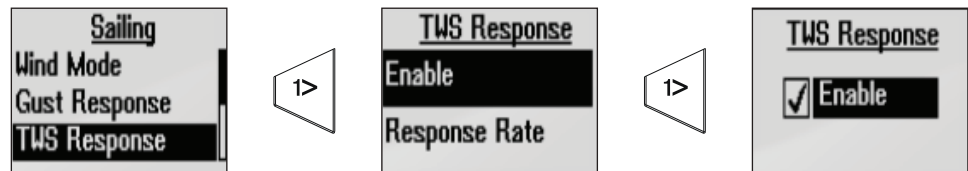

Response rate

Set the rate of TWS response 1 to 10. 1 = slowest response, 10 = quickest response.

Tack time

Controls the rate of turn (tack time) when performing a tack in wind mode.

Range	Change per step	Default	Units
2 - 50	1	12	Second

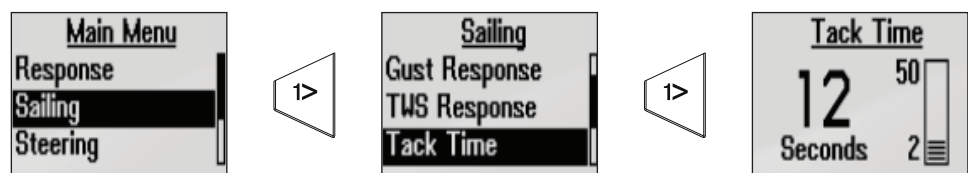

Tack angle

Controls the angle that the boat will tack to between 50° - 150°

→ **Note:** Only works in Auto mode.

Range	Change per step	Default	Units
0 - 180°	1	100°	Degrees

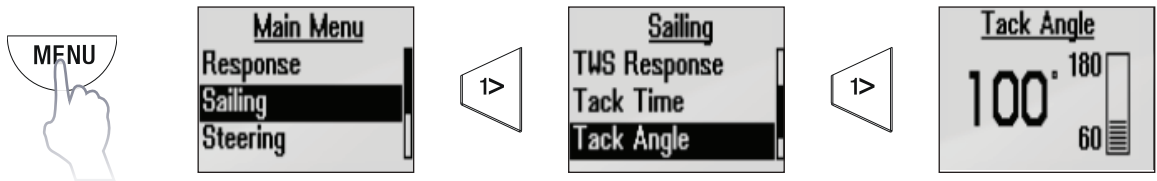

Heel compensation

Heel compensation provides protection against roll induced broaching in heavy seas or high gust conditions, by applying the correct amount of rudder compensation before adverse events become dangerous.

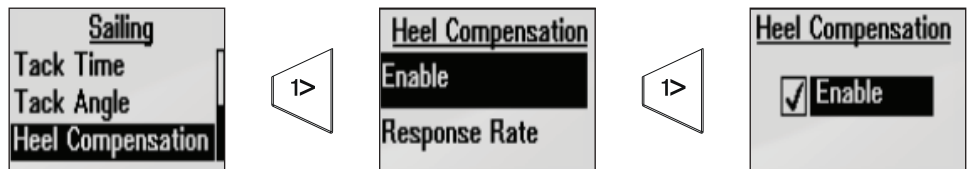

Response rate

Set the rate of heel compensation 1 to 10. 1 = slowest response, 10 = quickest response.

Steering

Auto response

The Auto response mode controls the rate that which the autopilot reacts to any environmental influences on the vessels desired course.

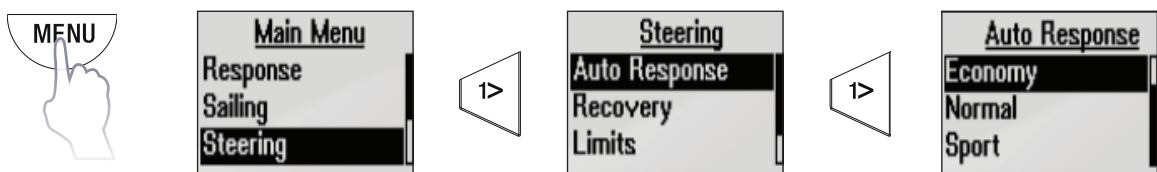

There are four auto response options available:

Off	The autopilot will always remain in the response mode selected.
Economy	The autopilot will need to sense large environmental changes before increasing the response setting.
Normal	The autopilot will need to sense moderate environmental changes before increasing the response setting.
Sport	The autopilot will be most sensitive to changing conditions and will automatically increase its response rate to counter environmental changes.

Recovery

Recovery Mode allows the user to set the sensitivity to course errors and how the autopilot will react to unexpected events, for example sudden wave or wind shifts. This function allows the autopilot to instantaneously increase the steering response to its maximum setting (Perf 5), and make a rapid recovery.

The Recovery Mode will automatically switch off after 15 seconds or when the heading error has been corrected. The autopilot will then resume the previous response setting and continue normal operation.

There are four options available.

Off	The Recovery Mode function is switched off.
Narrow	The autopilot is most sensitive to sudden course changes corrected.
Medium	The autopilot is configured to the medium value when correcting sudden course changes.
Wide	The autopilot is least sensitive to sudden course changes.

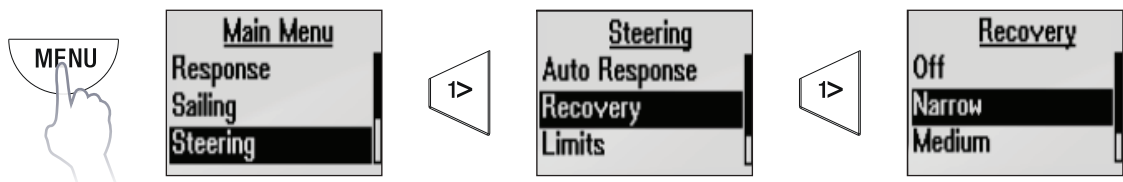

Limits

This allows control of the True Wind Angle range where Gust and True Wind Speed response can be configured and controlled.

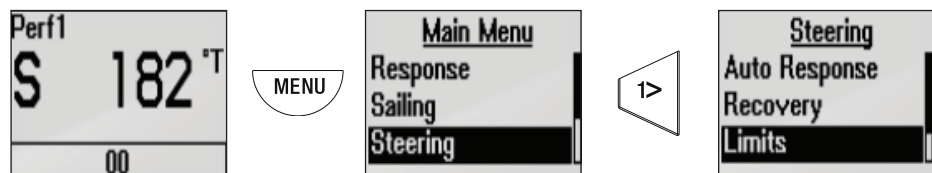

TWA minimum

Sets the minimum True Wind Angle that gust and True Wind Speed response operate in.

Use the **MODE / MENU** keys **UP/DOWN** to set the desired value. Press the **1° LEFT** key to return.

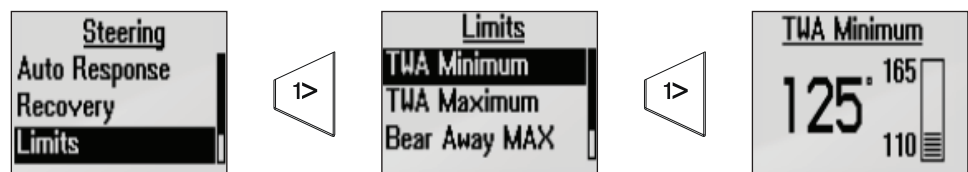

TWA maximum

Sets the maximum True Wind Angle that gust and True Wind Speed response operate in.

Use the **MODE / MENU** keys **UP/DOWN** to set the desired value. Press the **1° LEFT** key to return.

Bear away max

The maximum angle the vessel will bear away during stability control. 0° to 20°

Speed source

The Autopilot will automatically prioritize which speed source it uses.

Automatic speed source priority

- 1 Boat speed - Paddle wheel sensor
- 2 Speed Over Ground (SOG) - GPS sensor (Only used if there is no boat speed source)
- 3 Cruising speed - Used if no speed info is available. It is used by the autopilot system to calculate steering parameters. Decrease this value if the pilot is over active.

Manual speed source

If neither boat speed or SOG data is available and or deemed reliable a manual value for speed source can be entered and used by the autopilot to aid steering calculations.

- **Note:** Entering a speed source in the manual field will automatically make the autopilot use the manual speed source. Set the value back to zero to return to automatic speed source selection.

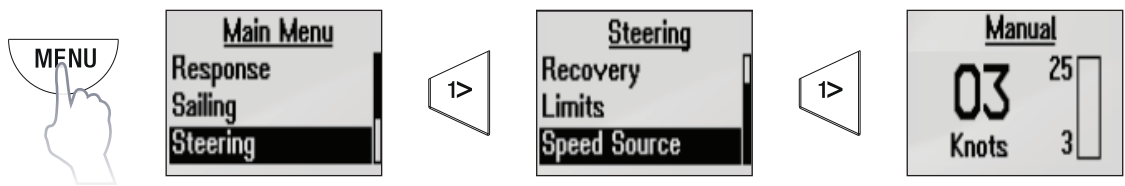

- **Note:** It is important that a close approximation of the vessel's boat speed is used.

8

Webserver

The B&G Webserver is an easy to use web-style portal that lets you calibrate instruments, configure displays and choose from an array of features. You can also access product manuals, data backups and system diagnostics.

- **Note:** An up to date web browser that supports websockets must be used to access the B&G webserver.

Connecting to the webserver

- **Note:** Before you can use the B&G webserver you will need to connect your PC directly to the H5000 CPU via an ethernet cable or wirelessly via a WiFi-1 router.

Direct via Ethernet

Connect a computer directly to the H5000 CPU via an ethernet cable.

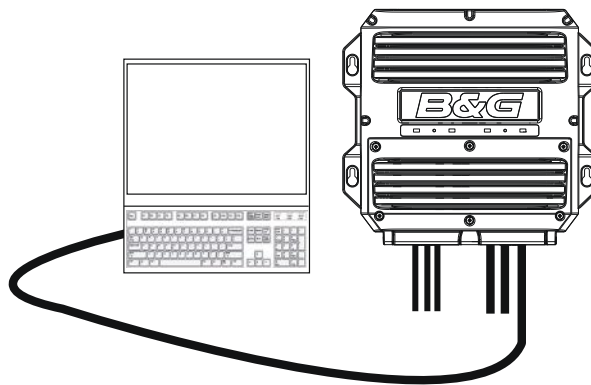

Wireless via a WiFi-1 router

Connect wireless devices to the CPU via a WiFi-1

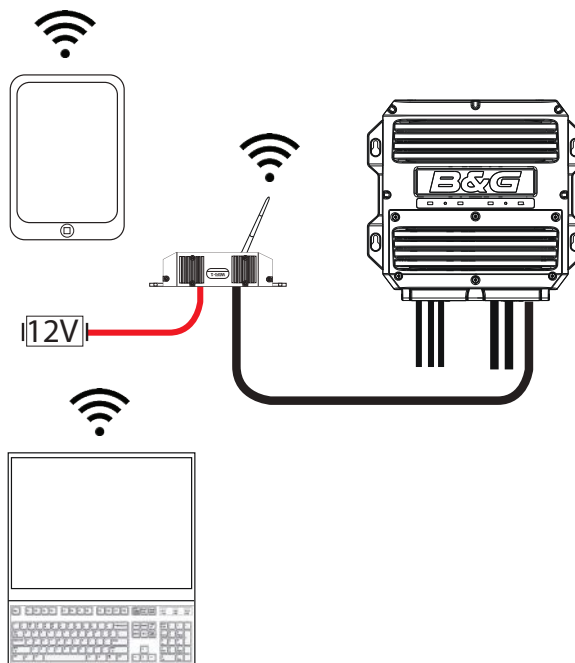

- **Note:** To connect the WiFi-1 router to the H5000 CPU an Ethernet to RJ45 converter cable is required.

Accessing the webserver

An up to date web browser that supports web sockets must be used to access the B&G H5000 Webserver.

Via Ethernet

- 1 Connect device to the CPU (as shown previously).
 - 2 Make sure the computer you wish to connect with is within the same IP address range as the CPU [192.168.0.XX].
 - 3 Open web browser on the connected computer or device.
 - 4 Type the IP address [192.168.0.2] into the web browser address bar
- **Note:** Unit will attempt to select a DHCP server for 2 minutes after power on. If the server is not detected the unit will revert to IP address [192.168.0.2]
- 5 Once connected correctly the B&G H5000 Webserver home screen will appear.



- **Note:** It will say “Websocket: Connected” in the top right-hand corner of the screen next to the help tab. If it says “Websocket: Not Connected” then check the CPU and router power and connections.

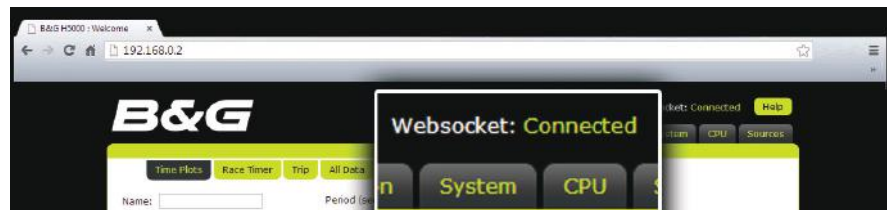

Via wireless WiFi-1 router

- 1 Connect device to the CPU (as shown previously).
 - 2 Open web browser on the connected computer or device.
 - 3 Find the IP address of the CPU via a Graphic Display.
- **Note** The CPU IP address can be found via the Graphic displays system network menu under CPU info. Make a note of this IP address.

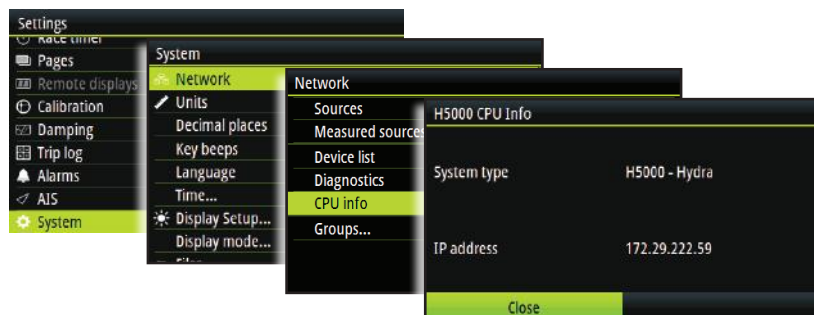

- 4 Type the CPU IP address into the web browser address bar
- **Note:** Unit will attempt to select a DHCP server for 2 minutes after power on. If the server is not detected the unit will revert to IP address [192.168.0.2]
- 5 Once connected correctly the B&G H5000 Webserver home screen will appear.

Webserver menus

The Webserver menu tabs can be found at the top of the web page. Select the desired main menu and the available sub menu tabs will be shown directly below as indicated.

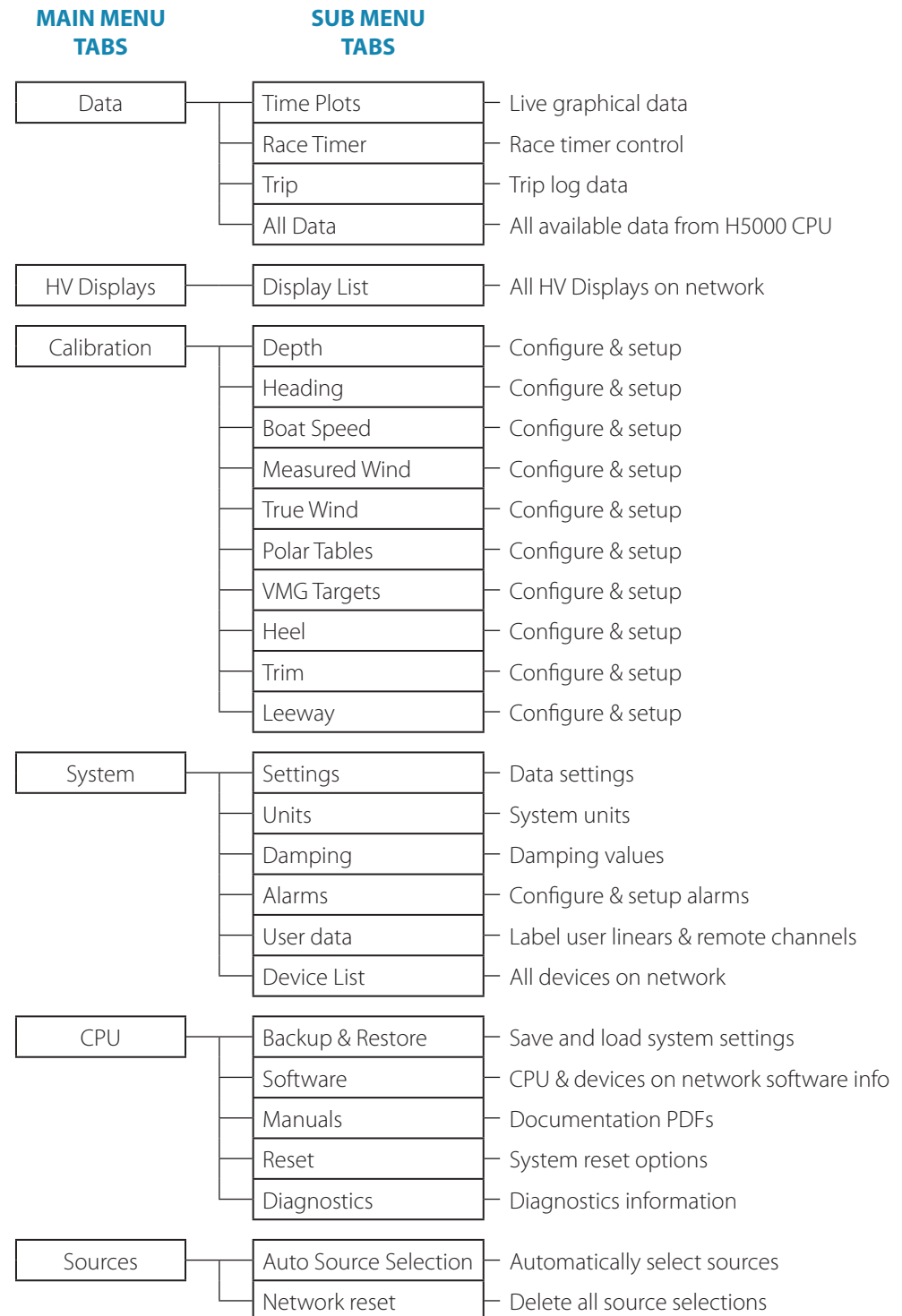

CPU software upgrade

Unlock code

Contact your local dealer to purchase an upgrade unlock code for Hercules or Performance systems. A list of B&G approved dealers can be found at www.bandg.com

Unlock CPU Software via Webserver

- 1 Open the webserver
- 2 Select CPU / Software tab
- 3 Check feature level for current software version

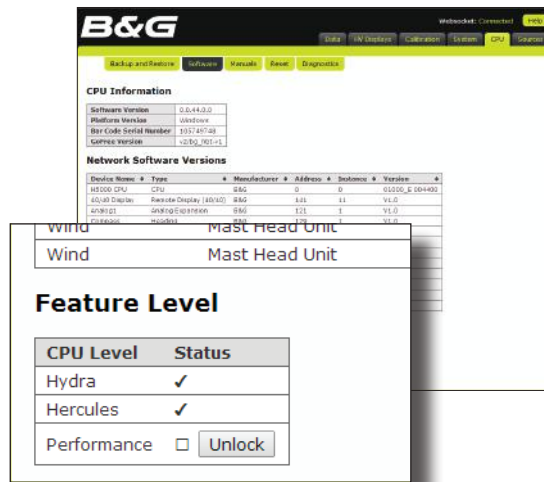

- 4 Purchase desired CPU level from an approved B&G dealer

→ **Note:** The CPU Bar Code Serial Number will be required to generate the unlock code. This number can be found under CPU Information on the software page.

- 5 Select 'Unlock' next to the CPU level your unlock code relates to
- 6 Enter the unlock code in the dialog box
- 7 Select 'OK' to complete
- 8 Once the upgrade is complete reboot the CPU by cycling the power

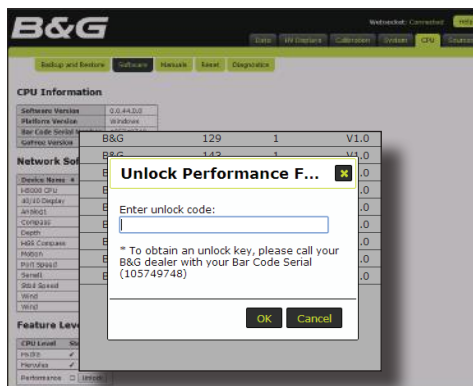

Webserver help files

Selecting the help tab located in the top righthand corner of the screen will show the help files related to the current page or feature.

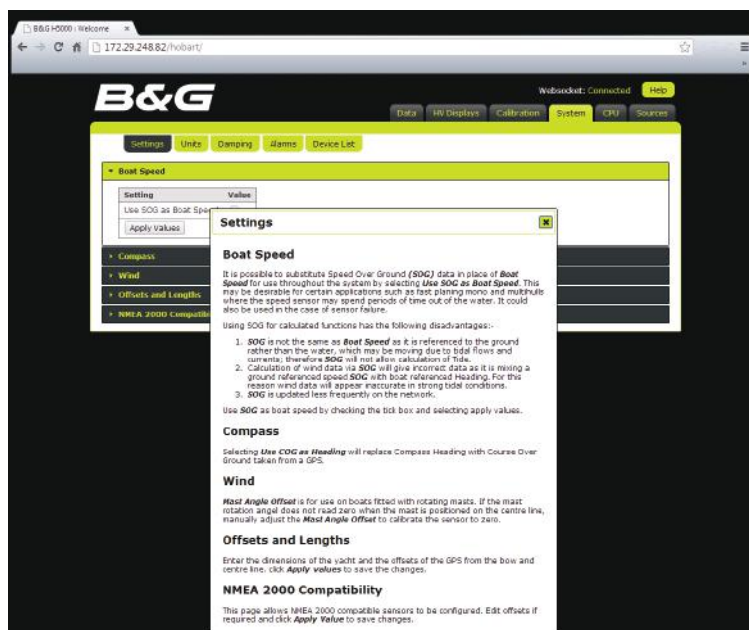
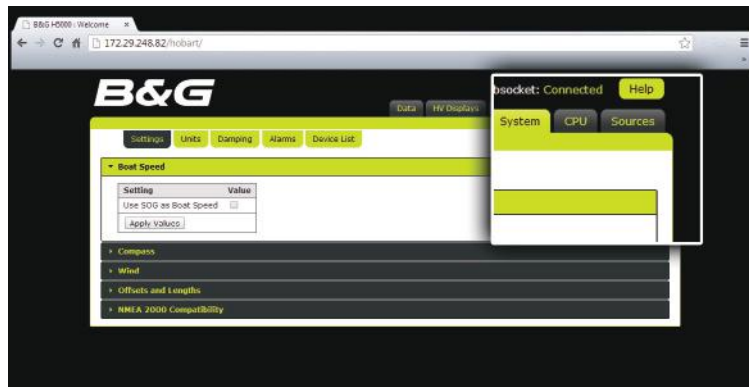

9

Operating variables

This section details the operating functions within the H5000 system.

The System Requirements sections advise of any additional requirements over a standard system.

For this purpose a standard system is taken as being a Graphic display and CPU with Wind, Speed, Depth and Compass sensors.

Where a function is obtained from a NMEA source the update rate published is the maximum, if the incoming NMEA data is slower this will affect the displayed data.

All variables described in this section refer to the standard Hydra processor settings unless indicated with a Hercules or Performance logo.



Indicates that the information listed relates to Hercules processor functionality which includes Hydra functions.



Indicates that the information listed relates to Performance processor functionality which includes Hydra & Hercules functions.

Please contact your local dealer if you wish to upgrade your processor. A list of B&G approved dealers can be found at www.bandg.com

Aft Depth

Aft Depth is an auxiliary depth function which allows the system to display two depth readings side by side.

Aft Depth is declared by the system when a valid source has been configured. The function name is Aft Depth by default, but it can be changed via the Webserver to suit the configuration (e.g. Forward Depth).

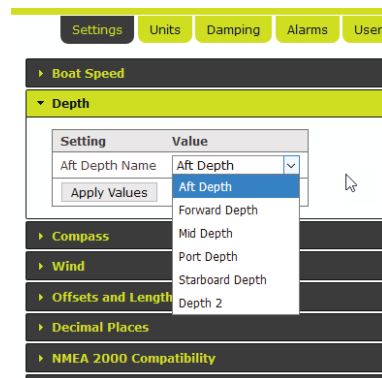

→ **Note:** Aft Depth is calibrated in the same manner as the standard depth. See "Depth" on page 50 for more details.

Variable name (default)	Aft Depth (ADep)
Function name (Race & HV Display)	DEPTH-A
Units	m, ft, fm
Alarms	Low (Shallow)
Calibration	Datum (offset)
Damping	N/A

Analog

There are four analog channels built into the CPU and multiple analog modules can be added to the network.

Once a device is wired into an analog channel it must be configured before it will provide the correct data.

Calibration of analog (linear) functions

For all linear functions it is necessary to set the Type value (see table below or one of the predefined functions listed in this section).

Description	Function declared
0 to 10 Linear	None
0 to 100 Linear	None
0 to 1000 Linear	None

The recommend procedure to calibrate is to set the linear function to a known position (i.e. "0.0" for daggerboard being fully up) and then record the voltage at this point. Then repeat the process for a different known position (i.e. "100" for daggerboard being fully down) and record this voltage. Once these points are known, enter them into the calibration options.

If the linear function is set to either of the above types, then you need to define a User Channel to send this data too. This channel can be renamed to suit the installation. See "User" on page 107 for more details.

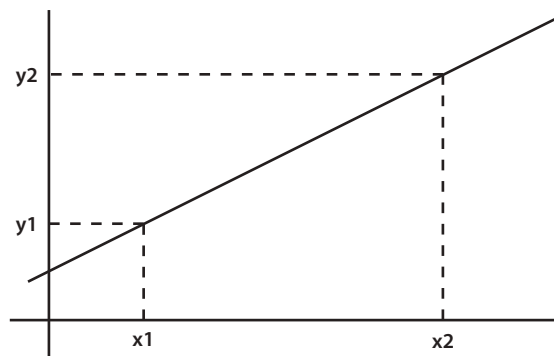

x1	=	Analog Volts 1
y1	=	Analog value 1
x2	=	Analog Volts 2
y2	=	Analog value 2

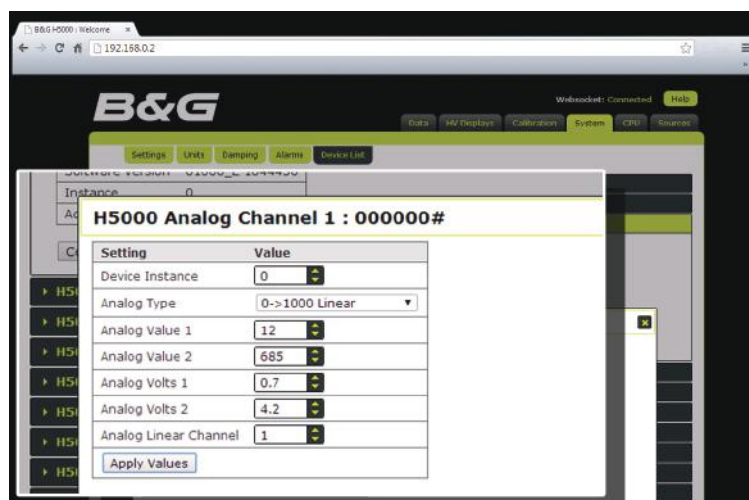

→ **Note:** The recommend calibration procedure for a positional sensor (i.e. Boom Angle, Rudder Angle, Keel Angle etc.) is to move the sensor to its maximum Starboard position, pressing the

Set button which will automatically record the voltage at this point. Next move the sensor to its minimum port position, press **Set** again to automatically record the voltage. Finally move the sensor to the center point and press **Set** again.



Apparent wind angle

Apparent wind angle (AWA) is the angle of the wind relative to the bow of the boat. The value displayed is back-calculated from the True wind data so as to include True wind correction data. Raw wind angle data from the masthead unit is displayed as Measured wind angle.

Variable name (default)	App. Wind angle (AWA)
Function name	AWA
Units	Degrees
Alarms	N/A
Calibration	MHU Offset, Heel correction On/Off AutoCal Offset routine.
Damping	N/A

Apparent wind speed

Apparent wind speed (AWS) is the speed of the wind relative to the boat. The value displayed is back-calculated from the True Wind data so as to include True wind correction data. Raw wind speed data from the masthead unit is displayed as Measured wind speed.

Variable name (default)	App. Wind speed (AWS)
Function name	AWS
Units	knots, kph, mph
Alarms	N/A
Calibration	Hz/Kt
Damping	0-9s

- **Note:** The calibration values are factory set based on wind-tunnel tested sample units and it is not recommended to change these. The option to change them exists for advanced users who may choose to individually test masthead units to obtain specific calibration data. Both calibration values are set to 1.04 by default.

Average speed

Average speed (AVS) is a Trip Function that displays the average Boat Speed [speed through the water] since the Trip log was started.

In simple terms this can be calculated as:

$$\text{Average Speed} = \frac{\text{Trip Log}}{\text{Trip Time}}$$

Variable name (default)	Average speed (AVS)
Function name	AVG SPD
Units	kt, mph, kph
Alarms	N/A
Calibration	N/A
Damping	N/A

Backstay



Backstay will display a value which indicates the load currently being applied to pull the mast backwards.

For calibration, see "Analog" on page 80.

Variable name	Backstay
Function name	Backstay
Units	Tonnes
Alarms	N/A
Calibration	Position 1 (known value 1) Volts 1 (voltage at known point 1) Position 2 (known value 2) Volts 2 (voltage at known point 2)
Damping	N/A

Barometric pressure

There is a calibration if you wish to check your pressure reading against another barometer. Enter an offset to adjust to the current reading to match a known pressure.

Variable name (default)	Barometric pressure (BARO)
Function name	BARO
Units	mb
Alarms	N/A
Calibration	Offset
Damping	N/A

Bearing to waypoint

Bearing to waypoint displays the bearing from the yachts current position (Boat Position) to the current active waypoint.

This function repeats information received from a position fixing device (e.g. GPS) via a NMEA input.

Variable name (default)	Bearing origin to destination
Function name	WPT BRG

Units	°M, °T Great Circle, Rhumb Line
Alarms	High, Low
Calibration	N/A
Damping	N/A

Bearing waypoint to waypoint

Bearing waypoint to waypoint displays the bearing of the current leg of a route, from the origin to destination waypoints. The value is constant until the position fixer advances to the next leg. This function repeats information received from a position fixing device (e.g. GPS) via a NMEA input.

Variable name (default)	Bearing to waypoint (BTW)
Function name	BRG WPT
Units	°M, °T Great Circle, Rhumb Line
Alarms	High, Low
Calibration	N/A
Damping	N/A

Boat position

Boat position displays the current boat position of the yacht. This function is only available on Graphic Displays.

This function repeats information received from a position-fixing device (e.g. GPS) via a NMEA input.

Variable name (default)	Boat position (POS)
Function name	N/A
Units	dd° mm.mm, ddd° mm.mm
Alarms	N/A
Calibration	N/A
Damping	N/A

Boat speed

Boat speed displays the speed of the boat through the water. Accurate calibration of Boat speed is critical to the overall performance of the system. On larger format displays an indicator showing acceleration/deceleration trend is displayed.

Boat speed displays either water speed value or SOG, if 'Use SOG as Boat Speed' is enabled.

Variable name (default)	Boat speed (BSpd)
Function name	BOAT SPD
Units	kt, mph, kph
Alarms	High, Low
Calibration	Distance Reference, known distance SOG Reference, reference speed Hz/Kt, port and starboard and single Linearity correction HERCULES Use SOG – Select SOG as alternative boat speed source.
Damping	0-9s Dynamic Damping HERCULES

Boom angle

Boom angle is designed to allow the boom angle to set accurately to allow furling systems to work with optimum efficiency. For calibration, see “Analog” on page 80.

Variable name	Boom angle
Function name	BOOM ANG
Units	Degrees
Alarms	N/A
Calibration	Maximum starboard position (known value) Volts (automatically recorded) Maximum port position (known value) Volts (automatically recorded) Center Volts (automatically recorded)
Damping	N/A

Boom position



Boom position is designed to allow the boom height to be set accurately to allow furling systems to work with optimum efficiency.

For calibration see “Analog” on page 80.

Variable name (default)	Boom position (Boom)
Function name	BOOM POS
Units	Arbitrary
Alarms	N/A
Calibration	Maximum Starboard Position (known value) Volts (automatically recorded) Maximum Port Position (known value) Volts (automatically recorded) Center Volts (automatically recorded)
Damping	N/A

Boom Vang



Boom Vang will display a value which indicates the load currently being applied to the vang.

For calibration, see “Analog” on page 80.

Variable name	Boom Vang
Function name	VANG
Units	Tonnes
Alarms	N/A
Calibration	Position 1 (known value 1) Volts 1 (voltage at known point 1) Position 2 (known value 2) Volts 2 (voltage at known point 2)
Damping	N/A

Canard angle



Canard Angle is designed to display the angle of a canard or forward rudder.

For calibration see "Analog" on page 80.

Variable name (default)	Canard (Can)
Function name	CANARD
Units	Degrees
Alarms	N/A
Calibration	Maximum Starboard Position (known value) Volts (automatically recorded) Maximum Port Position (known value) Volts (automatically recorded) Center Volts (automatically recorded)
Damping	N/A

Chain length

Chain Length will display a value that indicates the amount of chain currently in use for the anchor.

For calibration, see "Analog" on page 80.

Variable name	Chain Length
Function name	Chain
Units	Distance
Alarms	N/A
Calibration	Position 1 (known value 1) Volts 1 (voltage at known point 1) Position 2 (known value 2) Volts 2 (voltage at known point 2)
Damping	N/A

Code zero



Code Zero will display a value which indicates the load currently being applied from the Code Zero.

For calibration, see "Analog" on page 80.

Variable name	Code Zero
Function name	Code Zero
Units	Tonnes
Alarms	N/A
Calibration	Position 1 (known value 1) Volts 1 (voltage at known point 1) Position 2 (known value 2) Volts 2 (voltage at known point 2)
Damping	N/A

Course

Course is a combination of Heading and Leeway and gives a more accurate number than heading alone on which to base tacking angles etc.

In the absence of a Heel Angle sensor and/or Leeway calibration the Course value will be identical to the Heading.

Variable name (default)	Course (CSE)
Function name	COURSE
Units	°M, °T
Alarms	N/A
Calibration	Heading Node
Damping	Course is calculated on Damped Heading.

Course over ground

Course Over Ground (COG) displays the current course of the yacht relative to land (rather than the water), referenced to North.

Variable name (default)	Course Over Ground (COG)
Function name	COG
Units	°M, °T
Alarms	N/A
Calibration	N/A
Damping	0-9s

Cross Track Error (XTE)

XTE displays the distance the yacht is from the direct route (Great Circle or Rhumb Line depending on the position fixer) between two waypoints. The measurement is a perpendicular distance from the direct route to the yacht.

Variable name (default)	XTE
Function name	XTE
Units	nm
Alarms	N/A
Calibration	N/A
Damping	N/A

Cunningham



Cunningham will display a value which indicates the load currently being applied to the Cunningham.

For calibration, see "Analog" on page 80.

Variable name	Cunningham
Function name	CUNINGHM
Units	Tonnes
Alarms	N/A
Calibration	Position 1 (known value 1) Volts 1 (voltage at known point 1) Position 2 (known value 2) Volts 2 (voltage at known point 2)
Damping	N/A

Daggerboard

Daggerboard position will display a value which indicates the current vertical position of a daggerboard.

For calibration see "Analog" on page 80.

Variable name (default)	Daggerboard (Dag)
Function name	DAGGER
Units	As set by calibration
Alarms	N/A
Calibration	Position 1 (known value 1) Volts 1 (voltage at known point 1) Position 2 (known value 2) Volts 2 (voltage at known point 2)
Damping	N/A

Daggerboard port position

|||PERFORMANCE|||

Daggerboard port will display a value which indicates the current vertical position of a daggerboard.

For calibration, see "Analog" on page 80.

Variable name	Daggerboard port
Function name	DAGGER P
Units	N/A
Alarms	N/A
Calibration	Position 1 (known value 1) Volts 1 (voltage at known point 1) Position 2 (known value 2) Volts 2 (voltage at known point 2)
Damping	N/A

Daggerboard starboard position

|||PERFORMANCE|||

Daggerboard Starboard will display a value which indicates the current vertical position of a daggerboard.

For calibration, see "Analog" on page 80.

Variable name	Daggerboard Starboard
Function name	DAGGER S
Units	N/A
Alarms	N/A
Calibration	Position 1 (known value 1) Volts 1 (voltage at known point 1) Position 2 (known value 2) Volts 2 (voltage at known point 2)
Damping	N/A

Dead reckoning

Dead Reckoning provides Course and Distance from a base point, which is set when you start the function running, both the bearing from the start point and its distance in nautical miles can be displayed as separate functions.

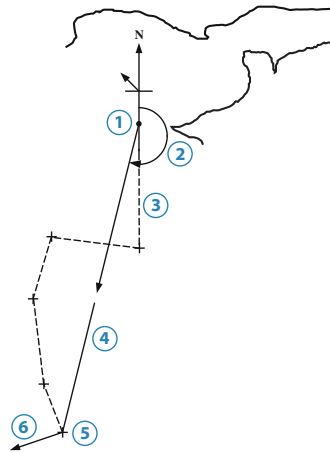

Dead Reckoning

No.	Description
1	Starting point
2	Course made good
3	Actual course sailed
4	Distance made good
5	Course reads: 213° Distance reads: 17.8 miles
6	Tide vector

D/R calculations are based on the Course function, therefore if a Heel Angle sensor is fitted the D/R data can be corrected for Leeway.

System requirements	N/A
Connection	N/A
Variable name (default)	D/RCourse, D/RDistance DRD/DRC
Function name	DR BRG and DR DIST
Units	°M, °T, nm
Alarms	N/A
Calibration	N/A
Damping	N/A

Depth

The depth offset adjustment allows the datum to be moved to give either depth below the keel, below the waterline or from the transducer face.

Variable name (default)	Depth
Function name	Depth
Units	m, ft, fm
Alarms	High (Deep), Low (Shallow)
Calibration	Datum
Damping	N/A

Distance to layline

This function displays the distance of both left and right-hand laylines by alternating the display between the two. A P or S is shown in the left hand digits to signify Port or Starboard laylines respectively

→ **Note:** The Race display doesn't show the P or S

Variable name (default)	Layline distance (dLL)
Function name	LL DIST
Units	Nm
Alarms	N/A
Calibration	N/A
Damping	N/A

Distance to waypoint

Distance to waypoint displays the distance from the yachts current position (Boat Position) to the current active GPS waypoint.

Variable name (default)	Distance to waypoint
Function name	WPT DIST
Units	Nm
Alarms	N/A
Calibration	N/A
Damping	N/A

Forestay

|||HERCULES|||

Forestay will display a value which indicates the load currently being applied to the Forestay. For calibration, see "Analog" on page 80.

Variable name	Forestay
Function name	FORESTAY
Units	Tonnes
Alarms	N/A
Calibration	Position 1 (known value 1) Volts 1 (voltage at known point 1) Position 2 (known value 2) Volts 2 (voltage at known point 2)
Damping	N/A

Ground wind - Direction

|||PERFORMANCE|||

Wind direction relative to the ground at a fixed position.

Variable name (default)	Ground wind direction
Function name	GWD
Units	°M, °T
Alarms	N/A
Calibration	N/A
Damping	N/A

Ground wind - Speed

|||PERFORMANCE|||

Wind speed relative to the ground at a fixed position.

Variable name (default)	Ground wind speed
Function name	GWS
Units	kt, m/s
Alarms	N/A
Calibration	N/A
Damping	N/A

Heading

Heading displays the compass heading relative to North (either Magnetic or True reference depending on sensor choice and system setup).

Variable name (default)	Heading (Hdg)
Function name	HDG
Units	°M, °T,
Alarms	N/A
Calibration	Offset AutoSwing (depending on sensor)
Damping	0-9s

Heading on opposite tack

Heading on opposite tack displays the compass heading that the yacht would be following after tacking to the same TWA on the other tack.

→ **Note:** This function does not take any tidal effects into consideration.

Variable name (default)	Heading Opp. Tack (OppT)
Function name	OPP HDG
Units	°M, °T,
Alarms	N/A
Calibration	N/A
Damping	N/A

Heel angle

The heel angle function displays the port/starboard inclination of the yacht. Heel data is used to calculate other functions including Leeway and Course. Heel angle is also used by Hercules systems to correct wind data for the change of orientation of the sensor in the airflow.

Variable name (default)	Heel
Function name	HEEL
Units	Degrees
Alarms	N/A
Calibration	Offset
Damping	0-9s

Inner Forestay Halyard Load

|||PERFORMANCE|||

Inner Forestay Halyard will display a value which indicates the amount of load being applied to the Halyard of the Inner Forestay.

For calibration, see "Analog" on page 80.

Variable name	Inner Forestay Halyard Load
Function name	INFSTY H
Units	Tonnes
Alarms	N/A
Calibration	Position 1 (known value 1) Volts 1 (voltage at known point 1) Position 2 (known value 2) Volts 2 (voltage at known point 2)
Damping	N/A

Inner Forestay Load

|||PERFORMANCE|||

Inner Forestay will display a value which indicates the amount of load being applied to the Inner Forestay.

For calibration, see "Analog" on page 80.

Variable name	Inner Forestay Load
Function name	INFSTY
Units	Tonnes
Alarms	N/A
Calibration	Position 1 (known value 1) Volts 1 (voltage at known point 1) Position 2 (known value 2) Volts 2 (voltage at known point 2)
Damping	N/A

Jib Furl

|||PERFORMANCE|||

Jib Furl will display a value which indicates the amount of load being applied to the Jib Furler.
For calibration, see "Analog" on page 80.

Variable name	Jib Furl
Function name	JIB F
Units	Tonnes
Alarms	N/A
Calibration	Position 1 (known value 1) Volts 1 (voltage at known point 1) Position 2 (known value 2) Volts 2 (voltage at known point 2)
Damping	N/A

Jib Halyard Load

|||HERCULES|||

Jib Halyard Load will display the amount of load currently being applied to the Jib Halyard.
For calibration, see "Analog" on page 80.

Variable name	Jib Halyard Load
Function name	JIB H

Units	Tonnes
Alarms	N/A
Calibration	Position 1 (known value 1)
	Volts 1 (voltage at known point 1)
	Position 2 (known value 2)
	Volts 2 (voltage at known point 2)
Damping	N/A

Keel angle



Keel Angle indicates the current axial position of a canting keel.

set POINT 2 to be a value equal to the angle of the keel (in this example 40.0), the voltage is automatically recorded and can be noted from VOLTS 2 if required.

For calibration see "Analog" on page 80.

Variable name (default)	Keel Angle (Keel)
Function name	KEEL ANG
Units	Degrees
Alarms	N/A
Calibration	Maximum Starboard Position (known value)
	Volts (automatically recorded)
	Maximum Port Position (known value)
	Volts (automatically recorded)
	Center
	Volts (automatically recorded)
Damping	0-9s

Latitude/Longitude

Latitude and Longitude are displayed on the Graphic display as Boat Position (refer to 'operating functions'.

Leeway

Leeway is the angle between the compass heading (Heading) and the course through the water (Course). The difference is caused by the boat slipping sideways through the water whilst sailing through the water.

H5000 calculates the Leeway function using the following equation:

$$\text{Leeway} = K \times H / V_s^2$$

Where K is the Leeway Coefficient, H is the Heel Angle and V_s is the Boat Speed through the water.

If the coefficient is set to "0", then the calculated leeway will be zero at all times.

Variable name (default)	Leeway (Lway)
Function name	LEEWAY
Units	° Degrees
Alarms	N/A
Calibration	N/A
Damping	Requires Leeway co-efficient (Webserver) to be entered in the webserver.

Local time

Displays local time from an interfaced position fixer. Ensure that your position fixer is configured to apply the correct local time offset.

→ **Note:** Not available on Race Display

Variable name (default)	Local Time (Time)
Function name	TIME LOC
Units	N/A
Alarms	N/A
Calibration	N/A
Damping	N/A

Mast angle

Mast Angle measurement is required for yachts with rotating masts as the wind sensor rotates with the rig, which introduces errors into the wind calculations. To correct for this issue a mast rotation sensor is fitted to the system, which provides the angle information.

Before Mast Angle can be used, the sensor needs to be configured. For setup and calibration see "Analog" on page 80.

When Mast Angle data is available all wind data is corrected to ensure that all angles are relative to the bow of the boat. In addition a new function, Wind Angle to Mast, is created.

Variable name (default)	Mast Angle (MST)
Function name	MAST ANG
Units	Degrees
Alarms	N/A
Calibration	Offset
Damping	N/A

Mast Cant angle

||| PERFORMANCE |||

Mast Cant will display a value which indicates the angle the mast.

For calibration, see "Analog" on page 80.

Variable name	Mast Cant Angle
Function name	MST CANT
Units	Degrees
Alarms	N/A
Calibration	Position 1 (known value 1) Volts 1 (voltage at known point 1) Position 2 (known value 2) Volts 2 (voltage at known point 2)
Damping	N/A

Mast rake



Mast Rake will display a value which indicates the current angle the Mast is tilted to.

For calibration, see "Analog" on page 80.

Variable name	Mast Rake
Function name	MST RAKE
Units	Degrees
Alarms	N/A
Calibration	Position 1 (known value 1) Volts 1 (voltage at known point 1) Position 2 (known value 2) Volts 2 (voltage at known point 2)
Damping	N/A

Measured wind angle

Measured Wind Angle is the angle measured by the masthead unit, no calibrations are applied except the basic offset value for alignment.

Measured Wind is not used whilst sailing, but is a useful function for checking the operation and alignment of the wind instruments before additional corrections are applied to the data during the calculation of the True Wind and Apparent Wind.

→ **Note:** Only available via the Webserver.

Variable name (default)	Measured Wind Angle (MWA)
Function name	MWA
Units	Degrees
Alarms	N/A
Calibration	Offset
Damping	N/A

Measured wind speed

→ **Note:** Only available via the Webserver

Measured Wind Speed is the wind speed measured by the masthead unit, no calibrations are applied except the factory set offset and Hz/Kt values. Measured Wind is not used whilst sailing, but is a useful function for checking the operation of the wind instruments before additional corrections are applied to the data during the calculation of the True Wind and Apparent Wind.

Variable name (default)	Measured Wind Speed (MWS)
Function name	MWS
Units	Kt
Alarms	N/A
Calibration	N/A
Damping	N/A

Next leg apparent wind angle



→ **Note:** Only available using a compatible chart plotter with an active route with next leg bearing data

Next Leg wind information is a prediction of the conditions of Apparent Wind Angle and Speed that the yacht will experience after altering course onto the next leg.

This data is calculated from the current True Wind and a bearing for the next leg course. From this information the True Wind Angle on the next leg is calculated, then by using the polar tables the corresponding Boat Speed is given and hence the Apparent Wind Speed and Angle can be calculated.

Should the leg be upwind or downwind, rather than free, the H5000 calculates the data using the Target TWA on the favoured tack, this situation is indicated on the display by the position of a small bar at the top (upwind) or bottom (downwind) of the digits.

Variable name (default)	Next Leg AWA (NL AWA)
Function name	NL AWA
Units	Degrees
Alarms	N/A
Calibration	N/A
Damping	N/A

Next leg apparent wind speed



See Next Leg Apparent Wind Angle for operation information.

Variable name (default)	Next Leg AWS (NL AWS)
Function name	NL AWS
Units	Kts, Kph, m/s
Alarms	N/A
Calibration	N/A
Damping	N/A

Opposite tack - COG



Opposite Tack displays the course over ground track that the yacht would be following after tacking to the same TWA on the other tack.

Variable name (default)	Opp COG
Function name	OPP COG
Units	°M, °T,
Alarms	N/A
Calibration	N/A
Damping	N/A

Opposite tack - Target heading



Opposite Tack target heading displays the heading the yacht will follow on the opposite tack using the target true wind angle.

Variable name (default)	Opp Targ
Function name	OPP TARG
Units	°M, °T,
Alarms	N/A
Calibration	N/A
Damping	N/A

Optimum wind angle



Optimum Wind Angle provides an alternative method of presenting Target TWA data, which some people find easier to use.

For every Target Boat Speed there is a wind angle at which that speed will be achieved (Target TWA). The Optimum Wind Angle is the difference between this angle and that at which you are presently sailing, so keeping the Optimum Wind Angle at zero achieves the Target TWA for Target Boat Speed.

If you are sailing at the optimum wind angle then you will achieve optimum VMG up/downwind for the current wind condition. Sometimes, particularly downwind, it is easier to try to sail to a wind angle rather than to the Target True Wind Angle (TWA). The accuracy of this function will depend on how accurate the polar tables are for your boat.

Variable name (default)	Optimum Wind Angle (OPT WA)
Function name	OPT TWA
Units	Degrees
Alarms	N/A
Calibration	N/A
Damping	N/A

Outhaul Load



Outhaul Load will display a value which indicates the load currently being applied to the Outhaul.

For calibration, see "Analog" on page 80.

Variable name	Outhaul Load
Function name	OUTHHAUL
Units	Tonnes
Alarms	N/A
Calibration	Position 1 (known value 1) Volts 1 (voltage at known point 1) Position 2 (known value 2) Volts 2 (voltage at known point 2)
Damping	N/A

Pilot active performance mode

Internal performance level used by the pilot when either Auto response or recovery mode is enabled. Varies between 1-5.

Variable name (default)	Active Perf Mode
Function name	ACTIVE PERF
Units	None
Alarms	None
Calibration	None
Damping	N/A

Pilot average heel

The average heel angle calculated by the pilot

Variable name (default)	Pilot Mean Heel
Function name	PLT AVG HEEL
Units	Degrees
Alarms	None
Calibration	N/A
Damping	N/A

Pilot gust bear away

Shows the angle adjustment applied to the target wind angle when a gust is encountered.

Variable name (default)	Gust bear away
Function name	GUST BA
Units	Degrees
Alarms	None
Calibration	Gust minimum
Damping	Gust response

Pilot heel compensation

Details the rudder angle applied to counteract any heel induced broach.

Variable name (default)	Heel compensation
Function name	HEEL COMP
Units	Degrees
Alarms	None
Calibration	N/A
Damping	Response rate

Pilot net course

The net magnetic course the pilot is steering to.

Variable name (default)	Pilot net course
Function name	NET CRSE
Units	Degrees
Alarms	None
Calibration	N/A
Damping	N/A

Pilot target wind angle

The internal wind angle the pilot is steering to and is adjusted for Gust and TWS Response changes if enabled.

Variable name (default)	Pilot target wind angle
Function name	PLT TARG WA
Units	Degrees
Alarms	None
Calibration	N/A
Damping	N/A

Pilot TWS response

Angle calculated and applied to the target wind angle when an increase in TWS is encountered.

Variable name (default)	TWS bear away
Function name	TWS BA
Units	Degrees
Alarms	None
Calibration	Gust minimum
Damping	Response rate

Pilot weather helm

Internally calculated weather helm rudder angle required to keep the pilot on a straight course.

Variable name (default)	Pilot weather helm
Function name	PLT WHELM
Units	Degrees
Alarms	None
Calibration	N/A
Damping	N/A

Pitch rate



→ **Note:** Hydra will show this data but cannot use it.

Pitch Rate displays the current value of Pitch Rate as used by Hercules Motion for wind correction. This function is shown for diagnostic purposes only.

→ **Note:** Also see Roll Rate.

Variable name (default)	Pitch Rate
Function name	PITCH
Units	Degrees per Second
Alarms	N/A
Calibration	N/A
Damping	N/A

Plow angle



Plow angle will display a value which indicates the angle of the anchor plow.

For calibration, see "Analog" on page 80.

Variable name	Plow angle
Function name	PLOW
Units	Degrees
Alarms	N/A
Calibration	Position 1 (known value 1) Volts 1 (voltage at known point 1) Position 2 (known value 2) Volts 2 (voltage at known point 2)
Damping	N/A

Polar boat speed



Polar Boat Speed is the predicted achievable boat speed for the current wind conditions. Unlike Target Boat Speed, which only applies whilst sailing upwind or downwind. Polar Boat Speed applies at all wind angles; it is therefore useful when sailing on a free leg.

The helmsman and trimmers can use this figure as the target to achieve maximum performance independent of any changes in the wind speed. The same data is also available via the Polar Performance % function in terms of Boat Speed as a percentage of Polar Boat Speed.

Variable name (default)	Polar speed (POL)
Function name	POL SPD
Units	Kt
Alarms	N/A
Calibration	N/A
Damping	N/A

Polar performance



Polar Performance displays boat speed as a percentage of the polar target for any given wind speed and True Wind Angle.

Variable name (default)	Polar performance (POL %)
Function name	POL PERF
Units	%
Alarms	N/A
Calibration	N/A
Damping	N/A

Rate of turn



Rate of Turn is damped Yaw Rate for display.

Variable name (default)	Rate of turn
Function name	TURN RTE
Units	Degrees per Second
Alarms	N/A
Calibration	N/A
Damping	N/A

Remote *n*



The Remote functions are declared (in the External menu) by the Hercules software and are used to display data from an external system (e.g. a PC running B&G Deckman) via the H-Link protocol.

Roll rate

→ **Note:** Hydra will show this data but cannot use it.

Roll Rate displays the current value of Roll Rate as used by Hercules Motion for wind correction. This function is shown for diagnostic purposes only.

→ **Note:** Also see Pitch Rate.

Variable name (default)	Roll rate
Function name	ROLL
Units	Degrees per Second
Alarms	N/A
Calibration	N/A
Damping	N/A

Rudder angle

Displays the current rudder angle. Useful for assessing the balance of the yacht, especially upwind.

Variable name (default)	Rudder angle (Rud)
Function name	RUDDER
Units	Degrees
Alarms	N/A
Calibration	Offset
Damping	N/A

Speed over ground

Speed Over Ground (SOG) displays the current speed of the yacht relative to land (rather than the water).

Variable name (default)	SOG
Function name	SOG
Units	kt
Alarms	N/A
Calibration	Offset
Damping	0-9

Stored log

The Stored log runs continually and records the total distance travelled by the yacht since the system was initially commissioned.

Variable name (default)	Stored log (Log)
Function name	STD LOG
Units	nm
Alarms	N/A
Calibration	N/A
Damping	N/A

Target boat speed



Target boat speed is the boatspeed at which optimum VMG will be achieved, derived from the polar table.

Variable name (default)	Target boat speed (TG SPD)
Function name	TARG SPD
Units	kt
Alarms	N/A
Calibration	N/A
Damping	N/A

Target true wind angle



Target TWA is the TWA at which optimum VMG will be achieved, derived from the polar table.

Variable name (default)	Target TWA (TG TWA)
Function name	TARG TWA
Units	Degrees
Alarms	N/A
Calibration	N/A
Damping	N/A

Temperature - Air

Air Temperature (AIR) displays the current temperature read via the sensor.

Variable name (default)	Air temperature (AIR)
Function name	AIR TEMP
Units	°C, °F
Alarms	High and Low
Calibration	Offset
Damping	N/A

Temperature - Aux

Displays the current temperature read via the sensor.

Variable name (default)	Aux temperature (AUX)
Function name	AUX TEMP
Units	°C, °F
Alarms	High and Low
Calibration	Offset
Damping	N/A

Temperature - Internal

Displays the current temperature read via the sensor.

Variable name	Internal temperature
Function name	Int Temp
Units	°C, °F
Alarms	N/A
Calibration	Offset
Damping	N/A

Temperature – Jacuzzi

|||PERFORMANCE|||

Displays the current temperature read via the sensor.

Variable name	Jacuzzi temperature
Function name	JACUZZI
Units	°C, °F
Alarms	N/A
Calibration	Offset
Damping	N/A

Temperature – Pool

Displays the current temperature read via the sensor.

Variable name	Pool temperature
Function name	POOL
Units	°C, °F
Alarms	N/A
Calibration	Offset
Damping	N/A

Temperature - Sea

Displays the current water temperature.

Variable name (default)	Sea temperature (Sea)
Function name	SEA TEMP
Units	°C, °F
Alarms	High and Low
Calibration	Offset
Damping	N/A

Tide set and rate

The system calculates current flow by comparing the Boat Speed and Course (which are measured relative to the water) to the ground referenced data (SOG and COG) from a GPS. This calculation therefore includes all water motion including both tides and permanent currents.

As the calculation utilizes the Course function its accuracy can be enhanced by the use of a Heel Angle sensor and accurate Leeway calibration.

- **Note:** If your position fixer sends magnetic bearing, check that the variation is correctly entered (or calculated) in the position fixer.

Importantly the damping on this function is adjustable, in rapidly changing tidal situations you need to lower the damping down as far as possible to be able to see the changes quickly. However in stable conditions, probably offshore, averaging the data over a longer time will normally give a more stable, accurate figure. In addition note that particularly frequent maneuvering can produce unreliable figures due to the lag in update from position fixing devices.

Variable name (default)	Tide set (T SET), Tide rate (T RTE)
Function name	TIDE SET, TIDE RTE
Units	°M, °T, nm
Alarms	N/A

Calibration	Magnetic variation
Damping	15 sec, 30 sec, 45 sec, 1 min, 2 min and 4 min

Time to layline

The information displayed shows the time to go before reaching the appropriate layline. A value of zero indicates that the layline has been reached. P and S are shown on Graphic Display to indicate time on each layline. Race Display only shows current layline.

- **Note:** This data is provided by Zeus MFD, normally using arbitrary tacking angles, as such it should only be considered an approximation.

Variable name (default)	Time to layline (tLL)
Function name	L/L TIME
Units	hh:mm:ss
Alarms	N/A
Calibration	N/A
Damping	N/A

Time to waypoint

Displays time until arrival at the active waypoint at the current speed and course.

Variable name (default)	Time to waypoint (t WPT)
Function name	TTW
Units	hh:mm:ss
Alarms	N/A
Calibration	N/A
Damping	N/A

Timer

The system Timer can be used for either countdown or as a straight-forward stopwatch.

- **Note:** If your position fixer sends magnetic bearing, check that the variation is correctly entered (or calculated) in the position fixer.

Variable name (default)	Timer
Function name	TIMER
Units	hh:mm:ss
Alarms	N/A
Calibration	Set countdown period
Damping	N/A

Trim (Fore/Aft)

The Trim function displays the fore/aft trim angle of the yacht.

Variable name (default)	Trim
Function name	TRIM
Units	Degrees
Alarms	N/A
Calibration	Offset
Damping	0-9s

Trim tab angle

Trim Tab Angle is designed to display the angle of an attached trim tab, traditionally this would be attached to the keel, however because this value is not used within the system for further calculation it can be used for any trim tab type device.

For calibration see "Analog" on page 80.

Variable name (default)	Trim Tab (Tab)
Function name	TRIM TAB
Units	Degrees
Alarms	N/A
Calibration	Maximum Starboard Position (known value) Volts (automatically recorded) Maximum Port Position (known value) Volts (automatically recorded) Center Volts (automatically recorded)
Damping	N/A

Trip log

The Trip log records the distance travelled through the water. The value displayed is the distance, in nautical miles, travelled from the time the Trip log was started.

- **Note:** There are two trip logs.
- **Note:** See "Trip log" on page 39 .

True wind angle

True Wind Angle is calculated from Measured Wind Speed, Measured Wind Angle and Boat Speed, this data is then combined with True Wind correction and heel angle correction values to create True Wind data. True Wind data is used to back-calculate Apparent Wind data as shown in the vector triangle below.

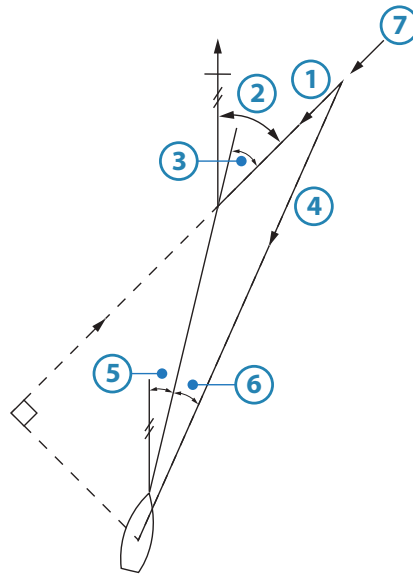

Wind Triangle

No.	Description
1	True Wind Speed
2	True Wind Direction
3	True Wind Angle
4	Apparent Wind Speed
5	Heading
6	Apparent Wind Angle
7	Wind

Variable name (default)	True Wind Angle (TWA)
Function name	TWA
Units	Degrees
Alarms	Sector
Calibration	True Wind Correction Tables AutoCal TWA correction routine
Damping	0-9s

True wind direction

True Wind Direction is the compass direction that the wind is coming from. It is calculated from the True Wind Angle and Heading and is therefore corrected for errors induced by aerodynamic effects via True Wind correction tables along with Heel Angle correction if available (Hercules).

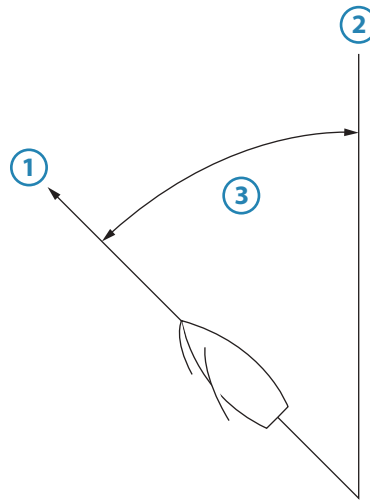

True Wind Direction

No.	Description
1	Heading = 240°
2	True Wind Direction = 280°
3	True Wind Angle = 40°

Variable name (default)	True Wind Angle (TWA)
Function name	TWA
Units	Degrees °m / °T
Alarms	N/A
Calibration	True Wind Correction Tables AutoCal TWA correction routine
Damping	0-9s

True wind speed

True Wind Speed (TWS) is the speed of the wind measured relative to the water surface.

Variable name (default)	True Wind Speed (TWS)
Function name	TWS
Units	kt, m/s
Alarms	High, Low
Calibration	True Wind Correction Tables
Damping	0-9s

User

User configurable linear.

- **Note:** There are 16 channels available for use.
- **Note:** Rename the user channel via the Webserver.

Variable name (default)	User
Function name	USER

UTC Time

Universal Co-ordinated Time (UTC) is equivalent to Greenwich Mean Time (GMT) and is the time used by all GPS systems. It is also referred to as Zulu Time (z) in some cases.

This function repeats information received from a position fixing device (e.g. GPS) via a NMEA input.

Variable name (default)	UTC Time (UTC)
Function name	TIME UTC
Units	hh:mm:ss
Alarms	N/A
Calibration	N/A
Damping	N/A

VMG

Velocity Made Good (VMG) is the component of Boat Speed in the direction of the True Wind.

VMG is used for monitoring performance of the yacht on upwind or downwind legs as the data considers both Boat Speed and True Wind Angle therefore indicating whether sailing slower, but closer to the wind, is better than sailing faster, but at a wider TWA.

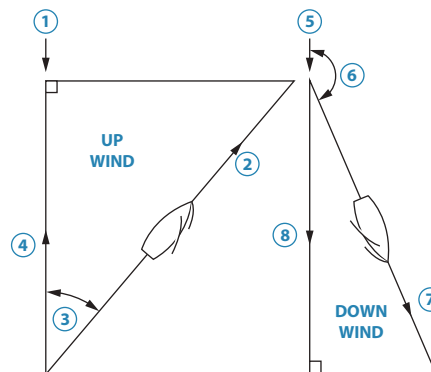

Calculation of VMG

No.	Description
1	True wind direction
2	Boat speed
3	True Wind Angle
4	VMG Upwind
5	True wind direction
6	True Wind Angle
7	Boat speed
8	VMG Downwind

Variable name (default)	Velocity Made Good (VMG)
Function name	VMG
Units	kt
Alarms	N/A
Calibration	N/A
Damping	0-9s

VMG performance



VMG Performance shows the current VMG as a percentage of the VMG derived from the polar table. The value is corrected for changes in wind speed.

Variable name (default)	VMG Performance (VMG Perf)
Function name	TACKING
Units	%
Alarms	N/A
Calibration	N/A
Damping	N/A

VMG to waypoint

Velocity Made Good, on Course to Waypoint (VMC) displays the component of your speed in the direction of the waypoint. Normally SOG is the speed reference used as the data is provided by the position fixer.

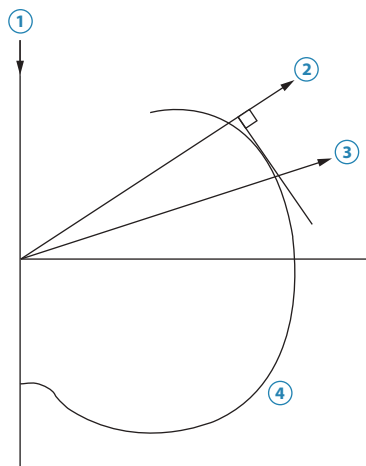

Optimum VMG to Mark

No.	Description
1	True wind direction
2	Direction of new mark
3	Optimum VMC course
4	Polar curve

Variable name (default)	VMG waypoint (VMC)
Function name	VMG CSE
Units	kt
Alarms	N/A

Calibration	N/A
Damping	N/A

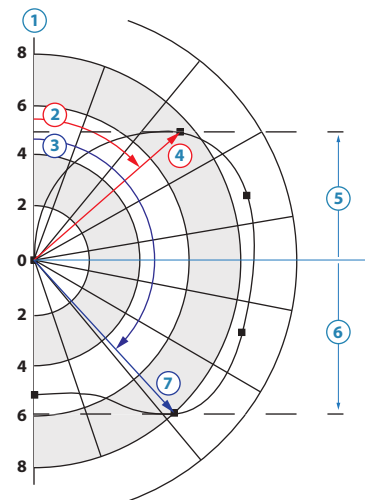

Polar Performance Curve

No.	Description
1	Boat speed Kts
2	Optimum True Wind Angle upwind
3	Optimum True Wind Angle downwind
4	Target boat speed upwind
5	Maximum VMG upwind
6	Maximum VMG downwind
7	Target boat speed downwind

The Polar Table describes the performance of the boat in all conditions of True Wind Speed and Angle. The Boat Speed is plotted radially against the True Wind Angle for each True Wind Speed in turn. The result is a Polar Performance Curve shown above, this shows the boat speed plotted for just one value of True Wind Speed.

Polar tables can be derived either by theoretical predictions, e.g. measurement certificates, or by analyzing the boat's actual performance via software such as Deckman. The H5000 has one polar table stored in its memory.

Water speed

Water speed displays the speed through the water calculated and calibrated from the paddle wheel.

Variable name (default)	Water speed
Function name	Water
Units	Knots, Mph, Kph,
Alarms	High, Low
Calibration	Distance Reference, known distance SOG Reference, reference speed Hz/Kt, port and starboard and single Linearity correction HERCULES Use SOG – Select SOG as alternative boat speed source.

Damping	0-9s Dynamic Damping HERCULES
----------------	---

Wind angle to mast

Wind angle to mast gives the Measured Wind relative to the mast of the yacht, effectively giving the angle of attack of the foil specifically for yachts equipped with rotating wing masts (or for non-wing masts to align the rig for minimum drag).

Variable name (default)	Mast MWA (WAM)
Function name	MAST AWA
Units	Degrees
Alarms	N/A
Calibration	N/A
Damping	N/A

Yaw rate

Yaw rate is the turn rate of the boat in degrees/second.

- **Note:** Yaw rate is displayed on the system for diagnostic purposes only. It is also used internally by the autopilot.

Variable name (default)	Yaw rate (Yaw)
Function name	YAW RATE
Units	Degrees
Alarms	N/A
Calibration	N/A
Damping	N/A

10

Example data tables

Polar table

		True Wind Angle																Target TWA Up	VMG Down	Target TWA Down	VMG Up	180	170	160	150	140	130	120	110	100	90	80	70	60	50	40	30	20																					
		180	170	160	150	140	130	120	110	100	90	80	70	60	50	40	30	20	180	170	160	150	140	130	120	110	100	90	80	70	60	50	40	30	20																								
2.5	2.5	1.56	1.87	2.08	2.13	2.19	2.10	2.02	2.00	1.98	1.99	1.97	1.90	1.87	1.84	1.80	1.75	1.70	1.80	1.80	1.80	1.84	1.87	1.90	1.97	1.99	1.98	1.99	2.00	2.02	2.10	2.13	2.19	2.08	1.87	1.56	40	1.80	40	1.80	1.70	1.80	1.84	1.87	1.90	1.97	1.99	1.98	1.99	2.00	2.02	2.10	2.13	2.19	2.08	1.87	1.56		
	5.0	2.70	3.04	3.29	3.52	3.75	3.83	3.91	3.90	3.85	3.76	3.65	3.50	3.25	3.01	2.80	2.60	2.40	2.85	2.85	2.85	3.01	3.25	3.50	3.65	3.76	3.85	3.90	3.83	3.91	3.90	3.75	3.52	3.29	3.04	2.70	39	2.85	39	2.85	2.40	2.80	3.01	3.25	3.50	3.65	3.76	3.85	3.90	3.83	3.91	3.90	3.75	3.52	3.29	3.04	2.70		
7.5	7.5	3.57	4.04	4.40	4.67	4.95	5.22	5.40	5.45	5.40	5.26	5.08	4.90	4.60	4.20	3.90	3.65	3.42	3.79	3.79	3.79	4.20	4.60	4.90	5.08	5.26	5.40	5.45	5.40	5.22	4.95	4.67	4.40	4.04	3.57	38	3.79	38	3.79	3.42	3.90	4.20	4.60	4.90	5.08	5.26	5.40	5.45	5.40	5.22	4.95	4.67	4.40	4.04	3.57	3.57			
	10.0	4.10	4.88	5.49	5.90	6.09	6.18	6.27	6.31	6.39	6.39	6.30	6.00	5.67	5.23	4.80	4.50	4.30	4.34	4.69	4.69	4.69	5.23	5.67	6.00	6.30	6.39	6.39	6.31	6.27	6.18	6.09	5.90	5.49	4.88	4.10	37	4.34	37	4.34	4.30	4.80	5.23	5.67	6.00	6.30	6.39	6.39	6.30	6.00	5.67	6.27	6.18	6.09	5.90	5.49	4.88	4.10	
12.5	12.5	4.50	5.30	5.99	6.50	6.69	6.79	6.88	7.02	7.10	7.11	7.06	6.87	6.67	6.30	5.80	5.50	5.29	4.69	4.69	4.69	6.30	6.67	6.87	7.06	7.11	7.10	7.02	6.88	6.79	6.69	6.50	5.99	5.30	4.50	36	4.69	36	4.69	5.29	5.80	6.30	6.67	6.87	7.06	7.11	7.06	6.87	6.67	7.02	6.88	6.79	6.69	6.50	5.99	5.30	4.50		
	15.0	4.80	5.66	6.54	6.95	7.07	7.22	7.30	7.45	7.59	7.65	7.65	7.51	7.38	7.04	6.60	6.31	6.02	5.00	5.00	5.00	7.04	7.38	7.51	7.65	7.65	7.59	7.45	7.30	7.22	7.07	6.95	6.54	5.66	4.80	35	5.00	35	5.00	6.02	6.60	7.04	7.38	7.51	7.65	7.65	7.51	7.38	7.04	7.45	7.30	7.22	7.07	6.95	6.54	5.66	4.80		
17.5	17.5	5.00	5.95	6.78	7.23	7.36	7.48	7.61	7.74	7.87	7.96	8.00	7.96	7.80	7.56	7.20	6.96	6.83	5.23	5.23	5.23	7.56	7.80	7.96	8.00	7.96	7.87	7.74	7.61	7.48	7.36	7.23	6.78	5.95	5.00	35	5.23	35	5.23	6.83	7.20	7.56	7.80	7.96	8.00	7.96	7.80	7.56	7.74	7.61	7.48	7.36	7.23	7.07	6.95	6.78	5.95	5.00	
	20.0	5.20	5.99	6.87	7.33	7.45	7.58	7.73	7.88	8.03	8.19	8.30	8.21	8.10	7.93	7.70	7.53	7.44	5.33	5.33	5.33	7.93	8.10	8.21	8.30	8.19	8.03	7.88	7.73	7.58	7.45	7.33	6.87	5.99	5.20	34	5.33	34	5.33	7.44	7.70	7.93	8.10	8.21	8.30	8.19	8.10	7.93	7.70	7.88	7.73	7.58	7.45	7.33	7.07	6.95	6.87	5.99	
22.5	22.5	5.50	6.15	6.86	7.35	7.51	7.67	7.89	8.11	8.30	8.40	8.43	8.36	8.28	8.19	8.05	7.93	7.88	5.37	5.37	5.37	8.19	8.28	8.36	8.43	8.40	8.30	8.11	7.89	7.67	7.51	7.35	6.86	6.15	5.50	34	5.37	34	5.37	7.88	8.05	8.19	8.28	8.36	8.43	8.40	8.36	8.28	8.19	8.05	8.05	7.93	7.88	7.67	7.51	7.35	6.86	6.15	5.50
	25.0	5.40	6.20	6.75	7.29	7.50	7.72	7.95	8.18	8.39	8.50	8.53	8.48	8.42	8.37	8.27	8.22	8.17	5.32	5.32	5.32	8.37	8.42	8.48	8.53	8.50	8.39	8.18	7.95	7.72	7.50	7.29	6.75	6.20	5.40	34	5.32	34	5.32	8.17	8.22	8.37	8.42	8.48	8.53	8.50	8.48	8.42	8.37	8.27	8.22	8.17	7.95	7.72	7.50	7.29	6.75	6.20	

Boat speed / Heel correction

Default boat speed and heel correction table. All values are set to zero.

		Column						
		0	1	2	3	4	5	6
Row	Boat Spd >	0	5	10	15	20	25	30
0	0° Heel	0.0	0.0	0.0	0.0	0.0	0.0	0.0
1	10° Heel	0.0	0.0	0.0	0.0	0.0	0.0	0.0
2	20° Heel	0.0	0.0	0.0	0.0	0.0	0.0	0.0

True wind angle correction

		Column						
		0	1	2	3	4	5	6
Row	TWS >	0	5	10	15	20	25	30
0	40° TWA	0	-7.0	-3.0	-2.5	4.5	6.5	8.0
1	90° TWA	0	-2.0	-1.0	0.0	1.0	1.0	1.5
2	165° TWA	0	4.0	3.0	1.0	-1.0	-1.0	-2.0

True Wind Speed correction

		Column						
		0	1	2	3	4	5	6
Row	TWS >	0	5	10	15	20	25	30
0	Correction	0	-0.6	-1.2	-1.8	-2.4	-3.0	-3.6

Downwind correction angle for TWS

		Column						
		0	1	2	3	4	5	6
Row	TWS >	0	5	10	15	20	25	30
0	Down angle	0	165	165	165	165	165	165

11

H-LINK Communications

H-Link is B&G's protocol for comprehensive and efficient interfacing of the H5000 Hercules CPU and an external PC, it is typically utilised by tactical software (such as B&G Deckman) or custom software for data monitoring on larger vessels.

H-Link features:

- Output of any available B&G function to PC
- Input of PC generated functions for display on Graphics and HV Displays
- Polar table access and control
- Calibration access and control
- Damping access and control
- Alarm access and control
- Editing of function display text
- Control of Trip functions e.g. Timer
- High update rates
- User (software) selected dataset

H-Link is available via either NMEA0183 (Serial Port) on the H5000 CPU.

H-Link uses a series of ASCII commands and responses, the detail of which is described in the following pages.

Communication Port Configuration

The H5000 CPU has two physical com ports that can be configured for H-Link, which is all done through the H5000 Webserver. The serial port needs to be configured as follows:

Baud rate	115,200
Parity	None
Data bits	8
Stop bits	1

Command Syntax

Commands are input as a string of ASCII characters starting with a character and a two-character command mnemonic followed by data fields separated by commas. The command is terminated and execution initiated by a carriage return line feed (CR) (LF).

A command line may not contain more than 88 characters including the start and the terminating carriage return (CR). Data parameters may be omitted provided that if a following parameter is needed the separating commas are included.

Message Format

The format of a data message will be as follows:

Data	*	CS (Checksum)	CR (Carriage Return)	LF (Line Feed)
------	---	---------------	----------------------	----------------

Checksums

The use of checksums in the message is mandatory.

The checksum shall appear in hexadecimal format at the end of the message directly after an * (asterix) character. The checksum shall be the 8-bit exclusive OR of all characters in the sentence, not including the * character.

Example:

The message we wish to send: #OV,1,1,73

Exclusive OR of characters: Decimal 18 = Hex 0x12

Transmitted Message: #OV,1,1,73*12<CR><LF>

End of Message.

Messages to and from the CPU shall finish with a Carriage Return followed by a Line Feed <CR><LF>

Data	*	CS (Checksum)	CR (Carriage Return)	LF (Line Feed)
#OV,1,1,73	*	12	CR	LF

Input and output of data

Almost all data available on the H5000 system in use, along with its associated parameters (Calibration, Damping, etc.), can be output to a PC by means of the #OV (Output Value) command.

Similarly, a number of externally generated data functions may be input to the H5000 system by means of the #IV (Input Value) command. #IV is also used to input system parameters to H5000.

These two commands are described in more detail as follows:

#IV (Input Value)	#IV,n,m,f,v[,t]
#OV (Output Value)	#OV,n,m,f[,o]

n	FastNet node number. Leave this field blank, H5000 will output the selected source.																																
m	FastNet message type: <table border="1" data-bbox="683 1104 1316 1469"> <thead> <tr> <th>Message type</th> <th>Description</th> <th>Input</th> <th>Output</th> </tr> </thead> <tbody> <tr> <td>1</td> <td>Function Data</td> <td>Yes</td> <td>Yes</td> </tr> <tr> <td>2</td> <td>Function Text</td> <td>Yes</td> <td>No</td> </tr> <tr> <td>211 - 214</td> <td>Cal Val 1 to Cal Val 4</td> <td>Yes</td> <td>Yes</td> </tr> <tr> <td>32</td> <td>Sector Alarm</td> <td>Yes</td> <td>Yes</td> </tr> <tr> <td>33</td> <td>Low Alarm</td> <td>Yes</td> <td>Yes</td> </tr> <tr> <td>34</td> <td>High Alarm</td> <td>Yes</td> <td>Yes</td> </tr> <tr> <td>206</td> <td>Damping</td> <td>Yes</td> <td>Yes</td> </tr> </tbody> </table>	Message type	Description	Input	Output	1	Function Data	Yes	Yes	2	Function Text	Yes	No	211 - 214	Cal Val 1 to Cal Val 4	Yes	Yes	32	Sector Alarm	Yes	Yes	33	Low Alarm	Yes	Yes	34	High Alarm	Yes	Yes	206	Damping	Yes	Yes
Message type	Description	Input	Output																														
1	Function Data	Yes	Yes																														
2	Function Text	Yes	No																														
211 - 214	Cal Val 1 to Cal Val 4	Yes	Yes																														
32	Sector Alarm	Yes	Yes																														
33	Low Alarm	Yes	Yes																														
34	High Alarm	Yes	Yes																														
206	Damping	Yes	Yes																														
f	Fastnet function number.																																
v	The value to input. → Note: If the message type is Function Text [type 2], then the value entered in this field should be the node number of the function.																																
o	Other value. This depends on the message type: <table border="1" data-bbox="608 1695 1383 1939"> <thead> <tr> <th>Message type</th> <th>Value</th> <th>Description</th> </tr> </thead> <tbody> <tr> <td rowspan="3">1 (Function Data)</td> <td>None</td> <td>None: outputs value once</td> </tr> <tr> <td>0</td> <td>Enables data for Streaming (see #OS)</td> </tr> <tr> <td>1</td> <td>Disables data for Streaming (see #OS)</td> </tr> <tr> <td>2 (Function Text)</td> <td></td> <td></td> </tr> </tbody> </table>	Message type	Value	Description	1 (Function Data)	None	None: outputs value once	0	Enables data for Streaming (see #OS)	1	Disables data for Streaming (see #OS)	2 (Function Text)																					
Message type	Value	Description																															
1 (Function Data)	None	None: outputs value once																															
	0	Enables data for Streaming (see #OS)																															
	1	Disables data for Streaming (see #OS)																															
2 (Function Text)																																	
t	Text string (maximum 8 characters).																																

The H5000 CPU will respond to a #OV request as follows: Vn,m,f,v

Example 1 - To request the current boat speed value:

Boat Speed is function number 65 and is a function data message Type 1, as such we send:

#OV,,1,65<CR><LF>

In this case H5000 will return:

V001,001,065,4.37

This indicates a Boat Speed value of 4.37 kt

Data	CR (Carriage Return)	LF (Line Feed)	Response
#OV,,1,65	CR	LF	V001,001,065,4.37

Example 2 - To input a new damping value of 3 seconds on Boat Speed:

#IV,1,206,65,3<CR><LF>

There is no response for this message type, if a confirmation is desirable in your application you may use a #OV message to request the relevant data from H5000.

Data	CR (Carriage Return)	LF (Line Feed)	Response
#IV,1,206,65,3	CR	LF	None

Example 3 - To rename text labels for linears 1 to 16:

#IV,255,2,56,5,(New Linear Label) <CR>

Data	New linear label	CR (Carriage Return)
#IV,255,2,56,5,	number ranging from 1 to 16	CR

Output position

#OL (Output Latitude & Longitude)

#OL[0|1]

The parameter following the #OL has the following options:

Parameter	Description
None	None: outputs value once.
0	Enables data for Streaming (see #OS).
1	Disables data for Streaming (see #OS).

The #OS command is used to control the streaming of position data, along with normal instrument data.

Streaming output data

#OS (Output Streaming)

This command starts or stops the streaming of function data. Any function data that has been enabled for streaming, by issuing an appropriate #OV or #OL command, is controlled by the #OS command:

#OS[0|1]

The parameter following the #OS has the following options:

Parameter	Description
0	Start output streaming for enabled data.
1	Stop output streaming (default).

Example:

Configure and start a data stream for multiple functions

Several functions for continuous (streaming) output and start the output will be enabled.

First we enable the data we require, in this case Boat Speed, True Wind Speed, True Wind Direction and Boat Position:

#OV,1,1,65,1

#OV,5,1,85,1

#OV,5,1,109,1

#OL,1

Then we start streaming data:

#OS,1

H5000 will then start to stream data in the standard output format. If we wish to temporarily halt the data we send #OS,0.

Data	Streaming	Output	Pause sending data
#OV,1,1,65,1	OS,1		#OS,0
#OV,5,1,85,1	OS,1		#OS,0
#OV,5,1,109,1	OS,1		#OS,0
#OL,1	OS,1		#OS,0

Table viewing and editing

The H5000 CPU contains a number of data tables associated with various correction values and, in the case of Hercules Performance, a full polar table for the purpose of calculating the various performance functions.

There is a generic command set described below which allows full upload and download access to all these tables:

#TO (Output from Table)	#TO[t,r[c]]
#TI (Input to Table)	#TI,t,r,c,v

t	Table number.																								
	<table border="1"> <thead> <tr> <th>Table</th> <th>Description</th> <th>Cols</th> <th>Rows</th> </tr> </thead> <tbody> <tr> <td>0</td> <td>Boat speed linearity/Heel angle correction</td> <td>7</td> <td>3</td> </tr> <tr> <td>1</td> <td>True wind angle correction value</td> <td>7</td> <td>3</td> </tr> <tr> <td>2</td> <td>True wind speed correction value</td> <td>7</td> <td>1</td> </tr> <tr> <td>3</td> <td>True wind speed downwind angle</td> <td>7</td> <td>1</td> </tr> <tr> <td>4</td> <td>Polar table</td> <td>22</td> <td>10</td> </tr> </tbody> </table>	Table	Description	Cols	Rows	0	Boat speed linearity/Heel angle correction	7	3	1	True wind angle correction value	7	3	2	True wind speed correction value	7	1	3	True wind speed downwind angle	7	1	4	Polar table	22	10
Table	Description	Cols	Rows																						
0	Boat speed linearity/Heel angle correction	7	3																						
1	True wind angle correction value	7	3																						
2	True wind speed correction value	7	1																						
3	True wind speed downwind angle	7	1																						
4	Polar table	22	10																						
r	Row number.																								
c	Column number.																								
v	The value to input.																								

The #TO command response depends on the number of parameters in the input string.

If all three parameters (table, row, column) are in the command then only the specified cell will be output, if two parameters (table and row, or table and column) are in the command then the specified row, or column, will be output.

If only the table parameter is in the command then the whole of the selected table will be output. If no parameters are in the command all the system tables will be output.

When more than a single cell is output, each output sentence will contain as many cell values from a single row of a single table as will fit in the message. At the end of the row a new

message will be started, if necessary.

The output format used is:

U,t,r,c1,v1,...,cn,vn

Trip and timer control

This command set allows control of the system trip functions, for example Race Timer and Trip Log:

Data	Description
#TC, st, d	#TC (Trip Control) st (Sub Type) d (Data)

Sub type	Data options										
t	Race timer control										
	<table border="1"> <thead> <tr> <th>Data value (d)</th> <th>Action</th> </tr> </thead> <tbody> <tr> <td>0</td> <td>Start timer countdown</td> </tr> <tr> <td>1</td> <td>Unfreeze (leaves running if already started)</td> </tr> <tr> <td>2</td> <td>Freeze timer</td> </tr> <tr> <td>3</td> <td>Synchronize timer</td> </tr> </tbody> </table>	Data value (d)	Action	0	Start timer countdown	1	Unfreeze (leaves running if already started)	2	Freeze timer	3	Synchronize timer
	Data value (d)	Action									
	0	Start timer countdown									
	1	Unfreeze (leaves running if already started)									
2	Freeze timer										
3	Synchronize timer										
v	Set Race timer start value (minutes)										
l	The value to input.										
	<table border="1"> <thead> <tr> <th>Data value (d)</th> <th>Action</th> </tr> </thead> <tbody> <tr> <td>0</td> <td>Reset trip log</td> </tr> <tr> <td>1</td> <td>Start trip log (leaves running if already started)</td> </tr> <tr> <td>2</td> <td>Freeze timer</td> </tr> </tbody> </table>	Data value (d)	Action	0	Reset trip log	1	Start trip log (leaves running if already started)	2	Freeze timer		
	Data value (d)	Action									
	0	Reset trip log									
1	Start trip log (leaves running if already started)										
2	Freeze timer										
d	Dead Reckoning (D/R) control.										
	<table border="1"> <thead> <tr> <th>Data value (d)</th> <th>Action</th> </tr> </thead> <tbody> <tr> <td>0</td> <td>Reset D/R</td> </tr> <tr> <td>1</td> <td>Start D/R (leaves running if already started)</td> </tr> <tr> <td>2</td> <td>Freeze D/R</td> </tr> </tbody> </table>	Data value (d)	Action	0	Reset D/R	1	Start D/R (leaves running if already started)	2	Freeze D/R		
Data value (d)	Action										
0	Reset D/R										
1	Start D/R (leaves running if already started)										
2	Freeze D/R										

Example:

Start countdown timer: #TC,t,0

Set new countdown time to 5 minutes: #TC,v,5

Freeze Trip Log: #TC,l,2

If the #TC command is sent without any of its parameters the current status of each item (Race Timer, Trip Log, D/R) is reported, in the format S,t,l,d.

Data	Start countdown timer	Set new countdown to 5 minutes	Freeze Trip Log	No. description
#TC, st, d	#TC,t,0	#TC,v,5	#TC,l,2	0 - stopped 1 - running 2- frozen

H5000 Function numbers

Function	Function number
AFT DEPTH	199
AIR TEMPERATURE DEGREES C	29
AWA	81
AWS KNOTS	77
BACKSTAY	282
BARO PRESSURE	135
BATTERY CURRENT	183
BATTERY VOLTS	141
BOAT LENGTH ADV	280
BOAT SPEED	65
BOBSTAY *	340
BOOM ANGLE	297
BOOM POSITION	164
BOOM VANG	283
BTW GC MAG	230
BTW GC TRUE	229
CANARD ANGLE	103
CHAIN LENGTH	284
CODE ZERO	298
COG MAG	234
COG TRUE	233
COURSE	105
CUNNINGHAM	292
D0 PORT *	346
D0 STBD *	347
D1 PORT *	358
D1 STBD *	359
DAGGERBOARD PORT	315
DAGGERBOARD POSITION	163
DAGGERBOARD STARBOARD	316
DEFLECTOR LOAD PORT *	354
DEFLECTOR LOAD STBD *	355
DEPTH FEET	194
DEPTH METRES	193
DISTANCE TO PORT END	274
DISTANCE TO STARBOARD END	275
DISTANCE TO START LINE	152
DISTANCE TO START LINE BOAT LENGTHS	281

DISTANCE TO WAYPOINT GC	232
DISTANCE TO WAYPOINT VIA LAYLINE	261
DR BEARING	211
DR DISTANCE	129
ETA TO WAYPOINT VIA LAYLINE	262
FOIL PORT *	351
FOIL STBD *	350
FORE AFT TRIM	155
FORESTAY	64
GROUND WIND DIRECTION	311
GROUND WIND SPEED	312
HEADING	73
HEADING ON NEXT TACK	154
HEEL ANGLE	52
INNER FORESTAY	286
INNER FORESTAY HALYARD	287
J1 LOAD *	341
J2 LOAD *	342
J3 LOAD *	343
JACUZZI TEMPERATURE	293
JIB FURL	288
JIB HALYARD	289
KEEL ANGLE	102
LAYLINE DISTANCE	226
LEEWAY	130
LINEAR 1	56
LINEAR 10	21
LINEAR 11	22
LINEAR 12	23
LINEAR 13	24
LINEAR 14	25
LINEAR 15	26
LINEAR 16	27
LINEAR 2	57
LINEAR 3	58
LINEAR 4	59
LINEAR 5	16
LINEAR 6	17
LINEAR 7	18
LINEAR 8	19
LINEAR 9	20
MAG VAR	304
MAINSHEET LOAD *	345
MAST ANGLE	156
MAST CANT ANGLE	313
MAST RAKE	308
MAST BASE *	344

MOB DR BEARING	185
MOB DR RANGE	186
NEXT LEG AWA	111
NEXT LEG AWS	113
NEXT LEG BEARING	309
NEXT LEG TARGET SPEED	310
OPPOSITE TACK COG	306
OPPOSITE TACK TARGET HEADING	307
OPTIMUM WIND ANGLE	53
OUTHAUL	290
PITCH RATE	158
PLOW ANGLE	291
POLAR PERFORMANCE	124
POLAR SPEED	126
POOL TEMPERATURE	294
REMOTE 0	239
REMOTE 1	240
REMOTE 2	241
REMOTE 3	242
REMOTE 4	243
REMOTE 5	244
REMOTE 6	245
REMOTE 7	246
REMOTE 8	247
REMOTE 9	248
ROLL RATE	60
RUDDER ANGLE	11
RUDDER LOAD PORT *	356
RUDDER LOAD STBD *	357
RUDDERTOES IN	314
RUNNER LOAD PORT *	348
RUNNER LOAD STBD *	349
SEA TEMP DEGREES C	31
SOG	235
START LINE BEARING	272
START LINE BIAS	273
STORED LOG	205
TARGET BOAT SPEED	125
TARGET TWA	83
TIDAL DRIFT	131
TIDAL SET	132
TIME TO LAYLINE	252
TIME TO WAYPOINT VIA LAYLINE	260
TIMER	117
TRIM TAB ANGLE	104
TRIP AVERAGE BOAT SPEED 1	100
TRIP LOG DISTANCE 1	207

TWA	89
TWD	109
TWS KNOTS	85
V0 PORT *	360
V0 STBD *	361
V1 PORT *	362
V1 STBD *	363
VMG PERFORMANCE	285
VMG TO WAYPOINT	236
VMG TO WIND	127
WIND ANGLE TO MAST	157
XTE	238
YAW RATE	68

→ **Note:** Items listed using * (asterisk) are only available with a Diverse HLA Loadcell Amplifier connected to the system.

12

Maintenance

Basic maintenance procedures

Cleaning

A non abrasive cleaning cloth should be used to clean the displays. Use plenty of water to resolve and take away salt remains. Crystallized salt may scratch the coating if using a damp cloth. Apply minimal pressure to the screen.

Where marks on the screen can't be removed by the cloth alone, use a 50/50 mixture of warm water and isopropyl alcohol to clean the screen. Avoid any contact with solvents (acetone, mineral turpentine etc.), or ammonia based cleaning products, as they may damage the anti-glare layer, plastics bezel, or rubber keys.

Always fit the supplied protective sun cover when the displays are not in use.

Checking the keys

Make sure that no keys are stuck in the down position. If one is stuck, wiggle the key to free it back to normal.

Checking the connectors

The connectors should be checked by visual inspection only.

Push the connector plugs into the connector, if the connector plugs are equipped with a lock; ensure that this is in the correct position.

Software upgrades

Please contact your local dealer if you wish to upgrade your processor. A list of B&G approved dealers can be found at www.bandg.com

Through-hull housings

Keep the screw threads of through-hull housings well greased with silicone or water pump grease. Ensure that the outer surfaces of the housing are properly coated with anti-fouling paint.

Boat speed sensor (paddlewheel type)

Use a stiff brush to remove marine growth that may cause the paddlewheel to freeze, and then clean the surfaces with a very weak solution of household detergent. If fouling is very severe, push the paddlewheel axle out by using a small drift, and then very gently, wet sand the surface with a fine grade wet/dry paper.

Inspect the o-rings on both the sensor and the blanking plug and replace if necessary, and then lubricate with silicone lubricant or petroleum jelly (Vaseline®).

Winter Storage / Laying Up

Masthead unit

Storage of the masthead unit when the yacht is laid up afloat will increase the life of the transmitters. It should always be removed from the masthead before the mast is unstepped. It should be stored in its packing box with the vane and cups removed. The exposed socket and connector threads at the top of the mast should be smeared with silicone grease such as MS4 (Midland Silicones Ltd), and then protected with the plastic cap supplied with it.

The contacts in the masthead unit connector should be inspected for cleanliness and sprayed with a water inhibitor such as WD40. The outer casing of the connector should also be smeared with silicone grease.

The masthead unit must never be oiled. The bearings are of the sealed pre-lubricated type and any additional oil may cause chemical breakdown of the existing lubricant. Any scratch marks or corrosion on masthead unit spar should be rubbed clean with a soft cloth and lightly smeared with silicone grease. This should not be necessary if care is taken when hoisting or lowering the masthead unit, to protect it from collision against the rigging.

If the mast is un-stepped, care must be taken to ensure that the cable is not cut through, but disconnected at the junction box below decks. The bare ends of the cable should be smeared with silicone grease.



B&G

www.bandg.com

