

STANDARD
Mark 3
MARINE SEXTANT™

DAVIS 

How to Find Your Position with the Mark 3 Sextant

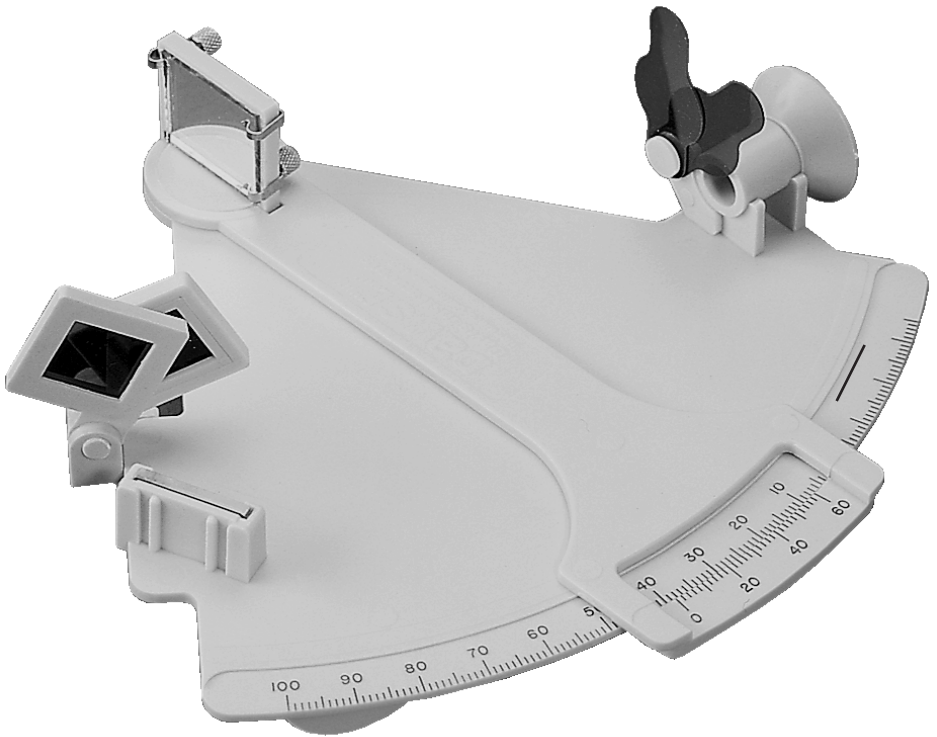

EDITED BY ROBERT B. KLEID
© 2008 Davis Instruments Corp.

**STANDARD
MARK 3
#011**

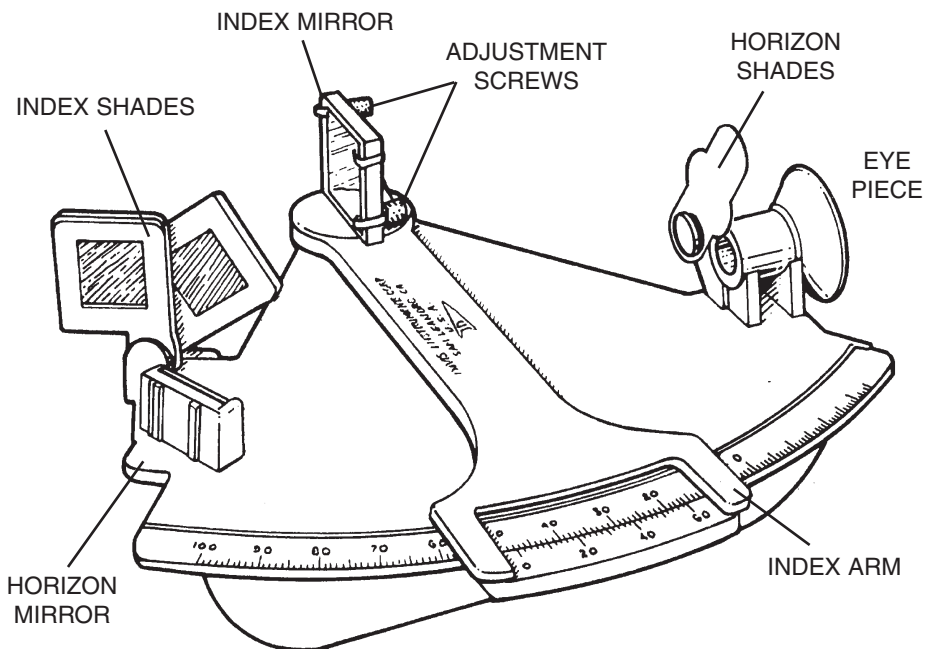

OPTIONAL PROTECTIVE CASE

Contact your local dealer or Davis Instruments to order.

R014A Sextant Case

R014B Foam Set for case



Mark 3 Sextant User's Guide

Product #011

© 2008 Davis Instruments Corp. All rights reserved.

00011.220, Rev. E October 2008

HOW TO FIND YOUR POSITION WITH A SEXTANT

This booklet has been written as an introduction to your new Davis sextant. By studying its pages, you will learn how to operate your sextant, how to find the altitude of the sun, and how to use your readings to calculate location. **The meridian transit method of navigation described is both easily learned and simply applied.** When you finish reading, the mystery surrounding celestial navigation and sextant use should disappear. Before becoming an accomplished navigator, however, you will need to study those aspects of navigation which are beyond the scope of this booklet.

HOW TO READ THE VERNIER

There are two scales on the sextant. The scale on the frame is called the “arc,” while the scale on the index arm is the “vernier.” Each division of the arc equals one degree. Each division of the vernier equals two minutes ($2'$). To read the number of degrees, find the lines on the arc which are closest to the zero mark on the vernier. The zero mark is usually somewhere between two lines. The correct arc reading is always that of the lower value, i.e., the line to the right of the zero mark. To read fractions of a degree, find the division of the vernier which is in alignment with a division of the arc.

To get a clear picture of how this works, set the zero on the vernier exactly beneath any whole degree mark on the arc—let’s say 30° . Now move the index arm very slightly to the left until the first vernier mark to the right of the zero lines up exactly with a mark on the arc. Since the marks on the vernier are $2'$ apart, you have actually moved the index arm $2'$ beyond 30° ; your sextant reads $30^\circ 02'$. Now, move the index arm slightly further to the left so that the next division of the vernier comes into alignment with a division of the arc. Your sextant now reads $30^\circ 04'$ (Fig. 1).

As you continue moving the index arm, successive divisions of the vernier will come into alignment with a division of the arc. When the last mark on the vernier ($60'$) is in alignment with a division of the arc, the sextant will read 31° . In figure 2 below, the sextant reads $43^\circ 26'$.

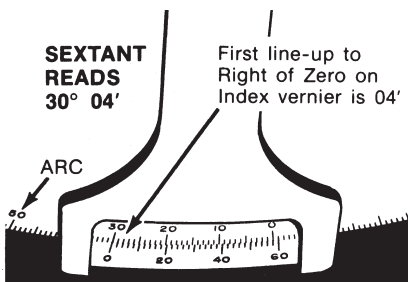

Figure 1

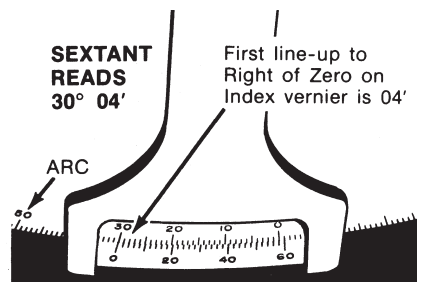
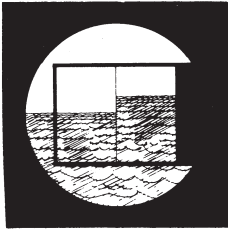

Figure 2

MARK 3 SEXTANT ADJUSTMENT

Adjusting your Mark 3 Sextant is easy and **should be done each time it is used**. All adjustments are made with the index mirror, the large movable mirror at the pivot of the index arm (it is not necessary to adjust the small horizon mirror, as the unit construction makes it impossible to be very much in error). On a correctly adjusted sextant, the index mirror is perpendicular to the frame and becomes parallel to the horizon mirror when the sextant reads zero.

First, adjust the index mirror for “side error” by making it perpendicular to the frame. Holding the sextant in your right hand, raise the instrument to your eye. Look at any horizontal straight edge (the sea horizon, for example, or the roof of a building at least one mile away) and move the index arm back and forth. The real horizon will remain still while the mirror horizon will appear only when the scales read close to zero. Line up the mirror horizon and the real horizon so that both appear as a single straight line (fig. 3).



Mirror horizon is not aligned with the real horizon—index arm is not in proper position.

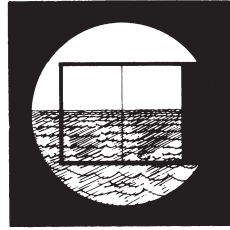

Mirror horizon and real horizon form a single straight line—index arm is properly positioned.

Figure 3

Now do a vertical adjustment. Without changing the setting, look through the sextant at any vertical line (a flag pole, for example, or the edge of a building) and swing the instrument back and forth across the vertical line. If the index mirror is not perpendicular to the frame, the line will seem to jump to one side as the mirror passes it. To correct this, slowly tighten or loosen the screw closest to the frame at the back of the index mirror until the vertical line no longer appears to jump (fig. 4).

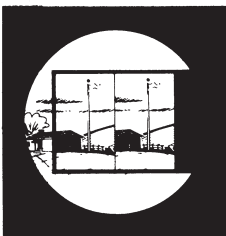

Index mirror screw too tight.



Index mirror screw correctly adjusted.

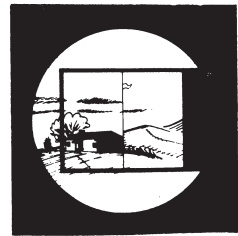

Index mirror screw too loose.

Figure 4

Finally, remove the index error. Set the sextant at zero and look at the horizon. With the sextant still held to your eye, turn the screw that is furthest from the frame at the back of the index mirror until the two horizons move together and form one straight line. The index mirror is now parallel to the horizon mirror (Fig. 5).

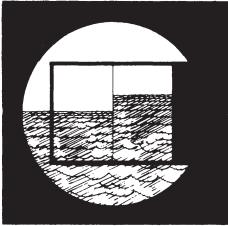

Index mirror not parallel to horizon mirror.

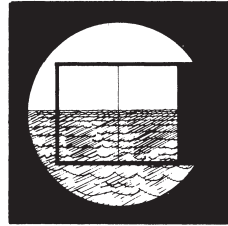

Index mirror parallel to horizon mirror.

Figure 5

On a correctly adjusted sextant, the real and mirror horizons remain in a single line when the instrument is rocked from side to side (Fig. 6).

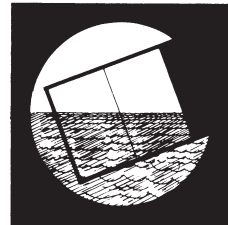
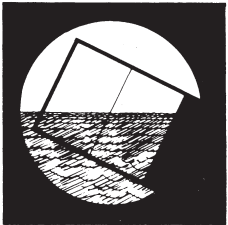

Figure 6

While you should know how to adjust your sextant for index error, it is not necessary to remove it entirely. It is standard practice to simply note the error and then correct one's reading for this amount each time the sextant is used (as much as 6' index error is allowable). To check for index error, hold the sextant in your right hand and look at the sea horizon. By moving the index arm, line up the real and mirror horizons so that both appear as a single straight line. Now, look at the scale. If it reads zero, there is no index error. If the scale reads anything but zero, there is an index error which must be added to or subtracted from each reading. For example, if the scale reads +6' when the horizons are aligned, the 6' is subtracted. If the reading is below the zero mark, for example -6', the 6' is added (Note: for an index error of -6', the scale actually reads 54').

MEASURING THE SUN'S ALTITUDE

When looking at the sun through the sextant, **be sure to use a sufficient number of shades to protect your eyes from the direct rays of the sun.** Choose the combination of index and horizon shades that gives you a clear image of the sun without glare.

To measure the sun's altitude, stand facing the sun with the sextant in your right hand. With your left hand on the index arm, look through the eye piece at the horizon and move the index arm until the sun is visible through the two mirrors and index shades. Rock the entire sextant from side to side so that the sun's image travels in a half-arc. Now, adjust the index arm to bring the sun's image down to just touch the horizon (Fig. 7).

Figure 7
The sun's image travels in a short arc which just touches the horizon.

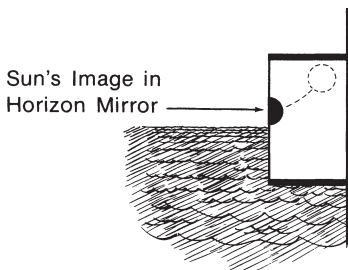

Being careful not to disturb the setting, read the sun's altitude from the scales on the sextant. Since all calculations in the Navigation Tables use the center of the sun or moon, this lower limb reading must be adjusted for semi-diameter correction, shown later.

HEIGHT OF EYE

When measuring the altitude of the sun, we want to measure the angle formed by a ray from the sun and a plane tangent to the earth at the point where the observer is standing. Due to the height of the eye of the observer, however, the visible horizon actually falls below this theoretical plane (Fig. 8).

To correct for the height of the eye, one must apply a "dip correction." Dip correction increases as the eye is raised further above the surface of the water (Table 1) and must always be subtracted from the sextant reading.

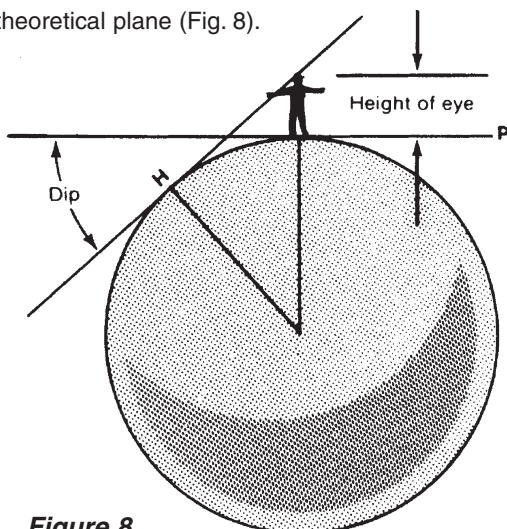

Figure 8
Due to the height of the eye of the observer, the visible horizon (H) falls below the plane (P) tangent to the earth at the point where the observer is standing.

Table 1

Height of Eye Correction

Feet	Meters	Dip
5	1.5	2'
10	3.0	3'
15	4.5	4'
25	7.5	5'
40	12.0	6'

LATITUDE, LONGITUDE, and the NAUTICAL MILE

A great circle is a circle on the surface of the earth, the plane of which passes through the center of the earth. A small circle is a circle whose plane does NOT pass through the center of the earth. The equator and the meridians are great circles, while parallels of latitude are small circles which become progressively smaller as the distance from the equator increases. At the poles (90° N or S), they are but single points (Fig. 9).

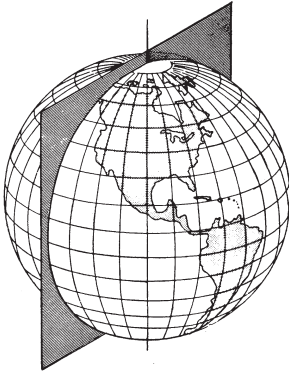

The plane of a meridian (a great circle) divides the earth into two equal halves.

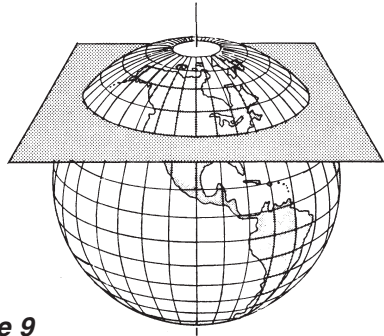

Figure 9

The plane of a parallel of latitude (a small circle) divides the earth into two unequal parts.

A nautical mile is equal to one minute of arc of a great circle. Since **latitude** is measured north or south from the equator, it is measured along a meridian (a great circle). One minute of latitude equals one nautical mile anywhere on the earth. Since **longitude** is measured east or west from the prime meridian (zero degrees) at Greenwich, England, it is measured along a parallel of latitude (a small circle). One minute of longitude equals one nautical mile only at the equator. Approaching the poles, one minute of longitude equals less and less of a nautical mile (Fig. 10).

Note that the nautical mile is about 15% longer than the statute mile:

Nautical Mile	Statute Mile
6076 feet	5280 feet
1852 meters	1609 meters

The earth measures 21,600 nautical miles in circumference (24,856 statute miles).

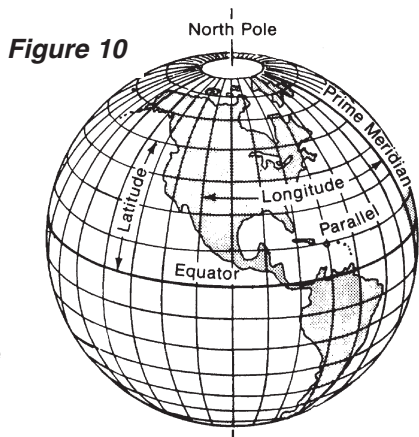

Figure 10

DECLINATION

Every star and planet, including the sun, has a **ground position**, i.e., the spot on the earth directly beneath it. Standing at the sun's ground position (G.P.), you would have to look straight up to see the sun; if you were to measure its altitude with a sextant, you would find the altitude was 90° .

From the earth, the sun seems to move across the sky in an arc from east to west. During certain times of the year, it is "moving" around the earth directly above the equator or, in other words, the sun's G.P. is running along the equator. Declination of the sun at this time is zero. However, the sun's G.P. does not stay at the equator throughout the year. It moves north to a maximum of $23\frac{1}{2}^\circ$ N in the summer of the northern hemisphere, and south to a maximum of $23\frac{1}{2}^\circ$ S in the winter. The distance of the sun's G.P. from the equator, expressed in degrees north or south, is known as the **declination of the sun** (Fig. 11).

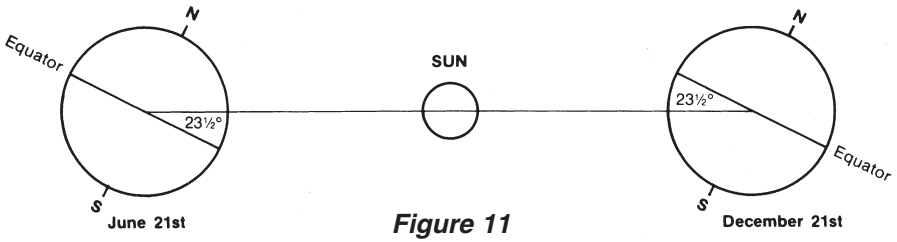

Figure 11

In like manner, **each star has a ground position and a declination.** The declination of Polaris is $89^\circ 05' N$; it is nearly directly above the North Pole. In the northern hemisphere, you can find your approximate position by taking a sight on Polaris. The reading will vary depending upon the time of night but will never be more than 55 miles off. This is a useful check each evening; the altitude of Polaris will be your approximate latitude without adding or subtracting anything. If you were to find the altitude of Polaris in the evening and again at dawn, your true latitude would be between the two measurements, providing you did not change latitude between the two sights. It is, of course, possible to calculate one's exact latitude from Polaris with the aid of the Nautical Almanac, but such a discussion is beyond the scope of this booklet.

To find Polaris, locate the pointers of the Big Dipper (Fig. 12). Find a point in line with the pointers and five times the distance between them. There, shining alone, is Polaris. The Big Dipper revolves around Polaris, so be prepared to see the diagram in any position.

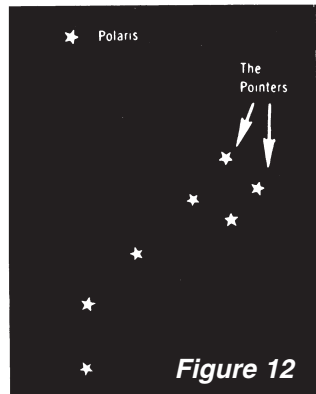

Figure 12

FINDING LOCAL NOON & THE SUN'S ALTITUDE AT MERIDIAN PASSAGE

A meridian is an imaginary line drawn on the earth's surface from pole to pole; a local meridian is one which passes through the position of an observer. When the sun crosses the local meridian, it is at its highest point. It is said to be in **meridian passage** and the time is **local noon**. Local noon may vary a half an hour (and in daylight savings time, one and one-half hours) from the noon shown on the clock, due to both the equation of time (to be discussed later) and the fact that our clocks are set to zone time. All clocks in a zone 15° wide show the same time.

To find local noon, follow the sun up with a series of sights, starting about half an hour before estimated local noon. Note the time and the sextant reading carefully. Take a sight about every three minutes until the sun's altitude is no longer increasing. During meridian passage, the sun will seem to "hang" in the sky for a short period at its highest point, going neither up nor down. Carefully note the sextant reading. This is **the sun's altitude at meridian passage**. To determine the exact time of local noon, set your sextant at the same altitude as your first sight. Wait for the sun to drop to this altitude, and note the time again. The time of local noon is exactly half way between the times of the two sights.

Record the local time and the sextant reading when the sun was at the highest point. These two readings will serve to locate your position. The time is used to determine longitude and the sextant reading to determine latitude.

AN EXAMPLE OF A COMPLETE SIGHT

Let us assume for this example that your ship is sailing from San Francisco to Hawaii and you have been using the sun to find your position each day. To allow plenty of time to follow the sun up to its highest point, you make sure that you have completed all your preparations by 10:00 a.m. local time. Your chart shows yesterday's position. From this position, you draw a line in the direction you are traveling equal in length to the estimated number of miles to be traveled by noon today. This is your "dead reckoning position" (D.R.), which will be compared with your "noon sight."

You note that you are standing on deck with your eye ten feet above the water (for Dip correction) and that the index error of your sextant is +5'.

At about 11:20 a.m., you begin taking sights. At 11:23:30, your first sextant reading is 82° 56'. You continue recording the sun's altitude approximately every three minutes until the sun seems to "hang" in the sky, dropping to a lower altitude at your next sight. The maximum altitude of the sun, 84° 56', is the altitude of the sun at meridian passage. You continue taking sights until 12:03:30, when the sun has dropped to your original reading of 82° 56'. You know that the sun reached its

meridian at 11:43:30 (exactly half the time between 11:23:30 and 12:03:30). Next, you find the Greenwich Mean Time (GMT) of your local noon by listening to the radio time signal, correcting any error your watch may have had. In this example, you tune in the time signal and find that GMT is now 22:10:00. Your watch reads 12:10:00, so it has no error. You know that your local noon occurred at GMT 21:43:30 (26 minutes 30 seconds ago).

You now have enough facts to work out your noon sight: the date, the time of meridian passage (local noon), the altitude of the sun at meridian passage, the height of your eye above the surface of the sea, and the index error of the sextant you are using.

FINDING LONGITUDE

Meridians of longitude are measured east or west from the prime meridian (zero degrees) at Greenwich, England. Because the ground position of the sun moves around the earth at an average speed of 15° per hour (15 nautical miles per minute), **longitude may be calculated by comparing local noon with Greenwich Mean Time.** For example, if local noon occurred at 2:00 GMT, your longitude is approximately 30° west of Greenwich (2 hours x 15°/hour = 30°).

To determine one's exact position, the **equation of time** must be applied. The earth in its orbit around the sun does not travel at a constant speed. Clocks and watches, therefore, keep the time of a fictitious or mean sun which travels at the same average speed throughout the year, and the position of the true sun (as seen from the northern half of the earth) is not always due south or 180° true at noon by the clock. The difference in time between the true sun and the mean sun is call the "equation of time." The equation of time for any given day may be found in a Nautical Almanac; its approximate value may be found in the student tables at the end of this booklet.

Example: The Longitude Calculation **Longitude: 2 June**

21 h 43 m 30 s	GMT of local noon (from observation above)
- 12 h 00 m 00 s	Greenwich noon
<hr/>	
09 h 43 m 30 s	Time from Greenwich to your ship
x 60	Minutes/hour conversion
<hr/>	
583.5 m	Minutes from Greenwich to your ship
x 15	G.P. of sun travels 15 minutes of arc/minute of time
<hr/>	
8752.5 m	Minutes of arc (nautical miles) from Greenwich
÷ 60	Minutes/degree conversion
<hr/>	
145° 52'.5 W	Longitude position of mean sun
+ 33'.0 W	Equation of time for 2 June (from student tables)
<hr/>	
146° 25'.5 W	Longitude of observer

See figure 13 for a diagram based on this example.

FINDING LATITUDE

The altitude of the sun at local noon may also be used to calculate latitude. First, the measured altitude must be corrected for index error, height of eye, refraction, and semi-diameter. Refraction correction is negligible for altitudes above 25°, while the semi-diameter correction averages +0° 16' (semi-diameter correction adjusts the sextant reading from an observation of the lower limb of the sun to one of the center of the sun; 16' equals one-half the sun's diameter). After the corrections are made, determine the declination of the sun from the Nautical Almanac or from the approximate declination values at the end of this booklet.

Finally, calculate latitude by combining the altitude of the sun at local noon with the declination of the sun from the navigation tables. Assuming you are north of the sun, the following formula is used in northern latitudes:

$$\text{Latitude} = 90^\circ - \text{Corrected Altitude} \pm \text{Declination of the Sun}$$

When the sun is north of the equator, ADD the declination; when it is south of the equator, SUBTRACT the declination.

Example: The Latitude Calculation **Latitude: 2 June**

Step One: Finding corrected altitude of the sun.

hs	84° 56'	Lower limb observation (your sextant reading at local noon)
- IC	5'	Index correction
	84° 51'	
- DIP	3'	Height of eye correction (see Fig. 8)
	84° 48'	
+ \odot	16'	Semi-diameter correction
Ho	85° 04'	Corrected altitude

Step Two: Applying the above formula for latitude

	89° 60'	Altitude of the sun at G.P. (89° 60' = 90°)
- Ho	85° 04'	Corrected altitude of the sun (from "Step One" above)
	4° 56'	Distance from the sun's G.P.
+	22° 08'	N Declination of the sun, north of the equator on June 2 (from student tables)
	27° 04'	N Latitude of observer

See figure 14 for a diagram based on this example.

Presentations shown here are commonly used by navigators to help insure the accuracy of their calculations:

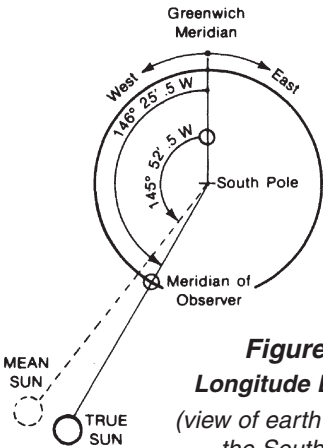

Figure 13
Longitude Diagram
(view of earth looking at the South Pole)

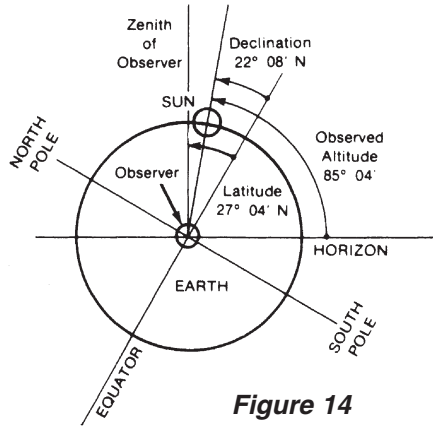

Figure 14
Latitude Diagram
(view of earth looking at the Equator)

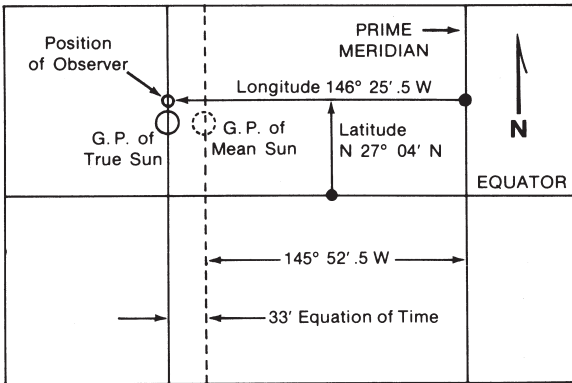

Figure 14
Position plot
on a chart.

SYSTEMS OF CELESTIAL NAVIGATION

The method described above for calculating your position is the oldest method used since the introductions of the chronometer. Please note the following:

1. Latitude may be determined at noon if you know the corrected altitude of the sun and its declination. You need not know the time. The accuracy of your calculation is limited only by the accuracy of measurement of the sun's altitude and by the accuracy of the declination tables.
2. To determine longitude, you must know both the time of observation and the equation of time. While your sextant gives highly accurate measurements, practical difficulties inherent in this method normally preclude accuracy of more than 10' of longitude.

A generalized system of position determination which enables you to use observation of the sun and other celestial bodies made at times other than noon requires knowledge of the navigation triangle, circles of equal altitude, assumed position, and associated navigation tables such as the Nautical Almanac and Sight Reduction Tables. These systems of celestial navigation are thoroughly studied and extensively used by serious navigators throughout the world.

Sets of work forms for the Sight Reduction Tables are used by nearly all navigators to help prevent errors and omissions in the calculation of celestial navigation problems.

THE ARTIFICIAL HORIZON

At times, it is not possible to see the natural horizon. Sun or moon shots may still be taken, with the aid of an artificial horizon—a simple device containing water or oil shielded from the wind (see below). It may be used by individuals exploring inland far from the sea, or by students or experienced navigators to practice celestial navigation without traveling to large bodies of water.



Davis Instruments manufactures the **Davis #144 Artificial Horizon**, pictured here. The instrument is wind-proof and corrosion resistant; its reflecting surface is completely enclosed. Two sun shades and a lid are included.

To use an artificial horizon:

1. Position the artificial horizon on level ground or other steady place. One end of the artificial horizon should face directly into the sun so that a shadow is cast at the opposite end. The sides and end facing the sun should be shadow-free.
2. Looking into the center of the liquid, move your head about so that you can see the sun reflected on the liquid surface.
3. Bring the sextant to your eye and move the index arm of the sextant until you see two suns—on reflected on the liquid and a double-reflected image on the mirrors.

4. Line the two suns up by continuing to move the index arm. For a lower limb observation, bring the bottom of the mirror image into coincidence with the top of the image on the liquid.
5. After the observation has been made, apply the index correction.
6. Halve the remaining angle and apply all other corrections (except for Dip or height of eye correction, which is not applicable) to find the altitude of the sun.

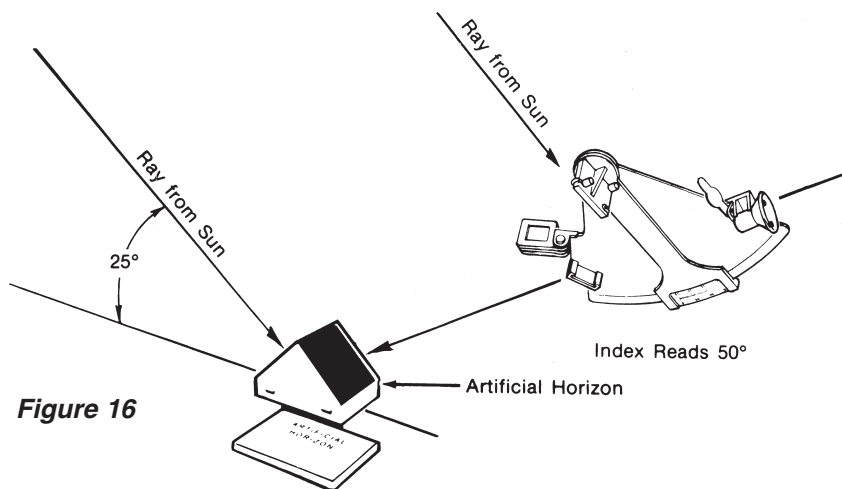

Note: Since the sextant reading made with an artificial horizon must be halved, the maximum altitude that you can observe with the artificial horizon is equal to one-half the maximum arc graduation on your sextant. There may be several hours around noon during which the sun is too high to take a sextant reading with the artificial horizon, so plan sights for the morning or evening hours.

THE SEXTANT AS A PELORUS

Your sextant may also be used to find your position by sighting known land objects such as lighthouses, small harbors, or any other land features that are clearly recognizable on the chart. Pick out three features on the land. With the sextant held horizontally, measure the angle between the center feature and one of the other features, and note the angle on a piece of paper. As quickly as you can, measure the angle between the center feature and the third feature. Lay out the three angles on a piece of tracing paper so that the angles have a common center point. Move the tracing paper around on the chart until the lines are positioned so as to run through the three features. The point of intersection of the three angles is your position (Fig. 17).

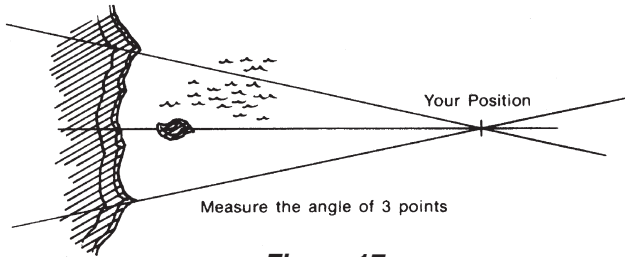

Figure 17

Since the sextant does not have a compass, you don't need to worry about variation or deviation. However, you must use at least three lines of position.

THE SEXTANT AS A HELIOGRAPH

You can use the sextant mirror to flash the sun's rays several miles to attract attention, or to signal another person who is too far away for your voice to reach. If you know Morse code, you could even send a message.

1. Hold the sextant so that the index mirror (the larger of the two mirrors) is just below the eye.
2. With your other arm extended and the thumb held upright, look at the person you wish to signal.
3. Hold your thumb to a position just below the person, so that your eye (with the mirror under it), your thumb, and the person are in a straight line (Fig. 18).
4. Using the mirror, flash the sun on your thumb. The sun flashes simultaneously on the distant person.

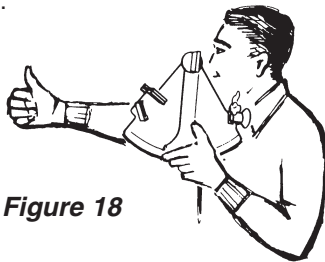

Figure 18

STUDENT NAVIGATION TABLES

The tables on the following pages give the approximate declination and equation of time of the sun. Latitude calculated with these values will be accurate to about $\pm 15'$. The tables are thus intended for study purposes only, although they may be used for emergency navigation.

NAUTICAL ALMANACS, CHARTS and TABLES

The Nautical Almanac is published yearly by the U.S. Naval Observatory and the H.M. Nautical Almanac Office, Royal Greenwich Observatory, U.K. It may be purchased from the superintendent of Documents, U.S. Government Printing Office, Washington, D.C., or from many marine and chart dealers.

Sight reduction tables, plotting sheets and star finders are also available from many marine and chart dealers.



FURTHER RESOURCES

Books for learning celestial navigation are available in many marine stores and larger bookstores. Most often recommended are *The American Practical Navigator* (U.S. Navy Hydrographic Office) and *Dutton's Navigation and Plotting* (U.S. Naval Institute). Other popular and regularly available titles are published by Cornell Maritime Press and the International Marine Publishing Co.

Videos are available from larger marine dealers, video mail order houses, and online.

Schools and courses are offered from local planetariums and community colleges in coastal areas. The U.S. Power Squadron (Raleigh, NC) also conducts regional classes. Other schools and correspondence schools include the International School of Sailing (Fort Lauderdale, FL) and Ocean Navigator Training Courses (Portland, ME).

Home study classes may be ordered from the International Navigation School (Toronto, Ontario, Canada), Starpath School of Navigation (Seattle, WA), Florida Maritime Institute (Stuart, FL), The Annapolis Sailing School (Annapolis, MD), and Coastal Navigation (Annapolis, MD).

REFERENCE: Approximate Declination & Equation of Time

	JANUARY		FEBRUARY		MARCH		APRIL	
	DEC	EQ	DEC	EQ	DEC	EQ	DEC	EQ
1	23° 01S	E0° 54'	17°12S	E3° 24'	7° 44S	E3°09'	4°23N	E1° 01'
2	22° 56S	E1° 00'	16° 54S	E3° 27'	7° 19S	E3° 06'	4° 49N	E0° 57'
3	22° 51S	E1° 08'	16° 36S	E3° 29'	6° 57S	E3° 03'	5° 11N	E0° 53'
4	22° 47S	E1° 15'	16° 20S	E3° 30'	6° 35S	E2° 59'	5° 35N	E0° 48'
5	22° 38S	E1° 18'	16° 00S	E3° 31'	6° 11S	E2° 55'	5° 56N	E0° 43'
6	22° 33S	E1° 28'	15° 44S	E3° 31'	5° 47S	E2° 53'	6° 20N	E0° 39'
7	22° 26S	E1° 35'	15° 25S	E3° 31'	5° 24S	E2° 50'	6° 44N	E0° 34'
8	22° 17S	E1° 38'	15° 05S	E3° 32'	5° 02S	E2° 46'	7° 05N	E0° 30'
9	22° 10S	E1° 45'	14° 47S	E3° 33'	4° 37S	E2° 42'	7° 25N	E0° 25'
10	22° 01S	E1° 52'	14° 26S	E3° 34'	4° 14S	E2° 38'	7° 50N	E0° 23'
11	21° 50S	E1° 58'	14° 08S	E3° 35'	3° 53S	E2° 33'	8° 11N	E0° 18'
12	21° 42S	E2° 02'	13°49S	E3° 33'	3° 26S	E2° 31'	8° 35N	E0° 14'
13	21° 33S	E2° 08'	13° 28S	E3° 34'	3° 03S	E2° 26'	8° 54N	E0° 11'
14	21° 21S	E2° 16'	13° 10S	E3° 34'	2° 41S	E2° 21'	9° 17N	E0° 06'
15	21° 11S	E2° 21'	12° 49S	E3° 34'	2° 51S	E2° 17'	9° 40N	E0° 03'
16	21° 00S	E2° 27'	12° 25S	E3° 34'	1° 51S	E2° 14'	10° 00N	W0° 01'
17	20° 47S	E2° 32'	12° 08S	E3° 32'	1° 30S	E2° 09'	10° 23N	W0° 04'
18	20° 36S	E2° 37'	11° 44S	E3° 31'	1° 05S	E2° 08'	10° 44N	W0° 09'
19	20° 25S	E2° 41'	11° 25S	E3° 30'	0° 43S	E2° 01'	11° 03N	W0° 12'
20	20° 12S	E2° 46'	11° 02S	E3° 29'	0° 17S	E1° 56'	11° 22N	W0° 15'
21	19° 57S	E2° 49'	10° 43S	E3° 27'	0° 05N	E1° 51'	11° 43N	W0° 18'
22	19° 44S	E2° 54'	10° 20S	E3° 26'	0° 31N	E1° 47'	12° 05N	W0° 21'
23	19° 31S	E2° 59'	9° 56S	E3° 23'	0° 54N	E1° 42'	12° 26N	W0°24'
24	19° 18S	E3° 01'	9° 33S	E3° 21'	1° 18N	E1° 38'	12° 43N	W0° 27'
25	19° 04S	E3° 07'	9° 12S	E3° 17'	1° 041N	E1° 33'	13° 06N	W0° 30'
26	18° 50S	E3° 10'	8° 47S	E3° 16'	2° 03N	E1° 29'	13° 24N	W0° 33'
27	18° 32S	E3° 12'	8° 30S	E3° 14'	2° 27N	E1° 24'	13° 44N	W0° 35'
28	18° 16S	E3° 16'	8° 06S	E3° 10'	2° 50N	E1° 19'	14° 05N	W0° 38'
29	18° 00S	E3° 18'			3° 14N	E1° 15'	14° 20N	W0° 39'
30	17° 46S	E3° 20'			3° 38N	E1° 10'	14° 40N	W0° 42'
31	17° 27S	E3° 23'			4° 00N	E1° 06'		

Equation of Time = True Sun E or W of the Mean Sun

Declination = Sun N or S of the Equator

	<u>MAY</u>		<u>JUNE</u>		<u>JULY</u>		<u>AUGUST</u>	
	DEC	Eq	DEC	Eq	DEC	Eq	DEC	Eq
1	14° 57N	W0° 44'	22° 00N	W0° 36'	23° 06N	E0° 53'	18° 07N	E1° 33'
2	15° 18N	W0° 45'	22° 08N	W0° 33'	23° 03N	E0° 56'	17° 55N	E1° 33'
3	15° 31N	W0° 46'	22° 18N	W0° 16'	23° 01N	E0° 59'	17° 37N	E1° 32'
4	15° 52N	W0° 48'	22° 23N	W0° 28'	22° 56N	E1° 03'	17° 23N	E1° 32'
5	16° 10N	W0° 49'	22° 31N	W0° 27'	22° 49N	E1° 05'	17° 05N	E1° 31'
6	16° 26N	W0° 51'	22° 38N	W0° 23'	22° 45N	E1° 09'	16° 50N	E1° 29'
7	16° 45N	W0° 52'	22° 45N	W0° 21'	22° 37N	E1° 12'	16° 32N	E1° 27'
8	17° 00N	W0° 54'	22° 50N	W0° 18'	22° 32N	E1° 13'	16° 15N	E1° 25'
9	17° 15N	W0° 55'	22° 53N	W0° 15'	22° 25N	E1° 14'	15° 59N	E1° 23'
10	17° 32N	W0° 56'	22° 59N	W0° 12'	22° 19N	E1° 17'	15° 41N	E1° 20'
11	17° 48N	W0° 56'	23° 03N	W0° 09'	22° 11N	E1° 19'	15° 25N	E1° 18'
12	18° 03N	W0° 56'	23° 08N	W0° 06'	22° 01N	E1° 23'	15° 06N	E1° 17'
13	18° 20N	W0° 57'	23° 10N	W0° 03'	21° 54N	E1° 24'	14° 47N	E1° 14'
14	18° 33N	W0° 57'	23° 16N	0° 00'	21° 44N	E1° 25'	14° 29N	E1° 12'
15	18° 46N	W0° 57'	23° 18N	E0° 03'	21° 37N	E1° 26'	14° 12N	E1° 09'
16	19° 03N	W0° 57'	23° 19N	E0° 06'	21° 25N	E1° 27'	13° 51N	E1° 06'
17	19° 16N	W0° 56'	23° 22N	E0° 09'	21° 17N	E1° 29'	13° 35N	E1° 03'
18	19° 27N	W0° 56'	23° 25N	E0° 12'	21° 05N	E1° 30'	13° 15N	E1° 00'
19	19° 41N	W0° 56'	23° 25N	E0° 15'	20° 55N	E1° 32'	12° 54N	E0° 57'
20	19° 53N	W0° 55'	23° 24N	E0° 19'	20° 46N	E1° 33'	12° 37N	E0° 52'
21	20° 06N	W0° 54'	23° 27N	E0° 23'	20° 35N	E1° 35'	12° 15N	E0° 50'
22	20° 19N	W0° 53'	23° 27N	E0° 25'	20° 23N	E1° 36'	11° 58N	E0° 44'
23	20° 30N	W0° 51'	23° 25N	E0° 29'	20° 10N	E1° 37'	11° 36N	E0° 41'
24	20° 43N	W0° 50'	23° 24N	E0° 31'	19° 58N	E1° 37'	11° 16N	E0° 36'
25	20° 53N	W0° 49'	23° 23N	E0° 36'	19° 44N	E1° 36'	10° 54N	E0° 33'
26	21° 03N	W0° 48'	23° 22N	E0° 39'	19° 31N	E1° 36'	10° 35N	E0° 28'
27	21° 15N	W0° 46'	23° 21N	E0° 42'	19° 19N	E1° 36'	10° 14N	E0° 24'
28	21° 24N	W0° 44'	23° 19N	E0° 45'	19° 06N	E1° 35'	09° 53N	E0° 20'
29	21° 33N	W0° 42'	23° 16N	E0° 46'	18° 50N	E1° 35'	09° 30N	E0° 16'
30	21° 43N	W0° 41'	23° 12N	E0° 51'	18° 38N	E1° 35'	09° 11N	E0° 13'
31	21° 50N	W0° 38'			18° 23N	E1° 34'	08° 48N	E0° 08'

	<u>SEPTEMBER</u>		<u>OCTOBER</u>		<u>NOVEMBER</u>		<u>DECEMBER</u>	
	DEC	EQ	DEC	EQ	DEC	EQ	DEC	EQ
1	08° 25N	E0° 02'	03° 00S	W2° 31'	14° 19S	W4° 06'	21° 43S	W2° 43'
2	08° 06N	W0° 01'	03° 25S	W2° 35'	14° 37S	W4° 06'	21° 53S	W2° 41'
3	07° 42N	W0°06'	03° 48S	W2° 41'	14° 57S	W4° 07'	22° 03S	W2° 35'
4	07° 21N	W0° 12'	04°10S	W2° 46'	15° 16S	W4° 07'	22° 11S	W2° 30'
5	06° 58N	W0° 18'	04° 34S	W2° 50'	15° 32S	W4° 07'	22° 18S	W2° 25'
6	06°37N	W0° 23'	04° 56S	W2° 34'	15° 52S	W4° 06'	22° 26S	W2° 19'
7	06° 14N	W0° 28'	05° 20S	W3° 00'	16° 10S	W4° 06'	22° 35S	W2° 12'
8	05° 52N	W0° 32'	05° 44S	W3° 05'	16° 27S	W4° 05'	22° 41S	W2° 04'
9	05° 30N	W0° 35'	06° 07S	W3° 10'	16° 45S	W4° 04'	22° 45S	W2° 00'
10	05° 06N	W0° 42'	06° 30S	W3° 13'	17° 00S	W4° 03'	22° 52S	W1° 53'
11	04° 45N	W0° 49'	06° 52S	W3° 15'	17° 18S	W4° 01'	22° 58S	W1° 44'
12	04° 21N	W0° 54'	07° 15S	W3° 20'	17° 34S	W4° 00'	23° 02S	W1° 39'
13	03° 57N	W0° 58'	07° 37S	W3° 24'	17° 51S	W3° 58'	23° 06S	W1° 32'
14	03° 34N	W1° 03'	07° 58S	W3° 29'	18° 08S	W3° 55'	23° 10S	W1° 25'
15	03° 13N	W1° 09'	08° 20S	W2° 32'	18° 22S	W3° 52'	23° 16S	W1° 17'
16	02° 48N	W1° 15'	08° 45S	W3° 34'	18° 38S	W3° 50'	23° 19S	W1° 10'
17	02° 25N	W1° 21'	09° 06S	W3° 36'	18° 53S	W3° 48'	23° 22S	W1°03'
18	02° 03N	W1° 24'	09° 30S	W3° 42'	19° 07S	W3° 45'	23° 23S	W0° 56'
19	01° 40N	W1° 31'	09° 45S	W3° 44'	19° 23S	W3° 41'	23° 24S	W0° 48'
20	01° 16N	W1° 31'	10° 12S	W3° 46'	19° 35S	W3° 37'	23° 25S	W0° 41'
21	0° 52N	W1° 41'	10° 33S	W3° 48'	19° 50S	W3° 35'	23° 27S	W0° 33'
22	0° 29N	W1° 47'	10° 55S	W3° 50'	20° 03S	W3° 31'	23° 27S	W0° 24'
23	0° 05N	W1° 52'	11° 15S	W3° 52'	20° 16S	W3° 25'	23° 26S	W0° 18'
24	0° 17N	W1° 56'	11° 35S	W3° 54'	20° 28S	W3° 21'	23° 25S	W0° 11'
25	0° 40S	W2° 01'	11° 58S	W3° 57'	20° 41S	W3° 16'	23° 24S	W0° 02'
26	01° 05S	W2° 08'	12° 16S	W3° 59'	20° 52S	W3° 14'	23° 23S	E0° 04'
27	01° 28S	W2° 11'	12° 36S	W4° 02'	21° 02S	W3° 08'	23° 22S	E0° 12'
28	01° 52S	W2° 16'	13° 00S	W4° 03'	21° 13S	W3° 02'	23° 19S	E0° 19'
29	02° 15S	W2° 21'	13° 20S	W4° 04'	21° 24S	W2° 59'	23° 16S	E0° 26'
30	02° 38S	W2° 28'	13° 39S	W4° 05'	21° 36S	W2° 53'	23° 12S	E0° 35'
31			13° 57S	W4° 06'			23° 07S	E0° 41'

REPLACEMENT PARTS

Contact your local dealer or Davis Instruments to order. Specify that your sextant is the #011 Mark 3.

- R011A** Index Shade Assembly
- R011B** 4 Springs, 2 Screws, 3 Nuts
- R011C** Index & Horizon Mirrors
w. Springs, Screws, Nuts
- R011X** Factory overhaul
(\$10.00 estimated charge)

CELESTIAL NAVIGATION AT A GLANCE

Celestial Navigation Quick Reference Card

This full-color, weatherproof plastic card presents a simplified yet complete celestial navigation system. Makes it easy, proving that lengthy instruction is not necessary to master the subject.

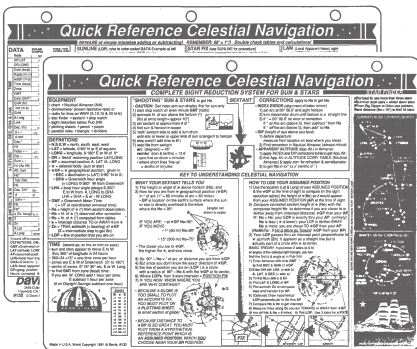

Includes everything you need: sextant use and corrections, starfinder for 18 stars, data entry form and step-by-step sight reduction and plotting procedures.

#132

OTHER DAVIS SEXTANTS

In addition to the Mark 3, Davis offers two models of master marine sextants.

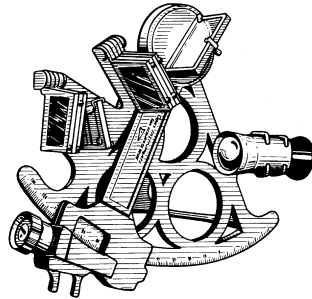

The **Mark 15** offers professional features—including micrometer drum, traditional styling, and greater accuracy than the Mark 3. Allows readings up to 2/10 minute of arc. 3 x 27 mm star telescope. Precision machined, slow travel gear and worm mechanism.

#026

The **Mark 25** has all the features of the Mark 15 plus LED lighting and the patented Beam Converger horizon mirror, which replaces the conventional half-silvered mirror. The Beam Converger combines the horizon and astrobody images into a single full-field view for easy, reliable sights under the most difficult conditions. Constructed with stronger and more stable materials to make this the most accurate of the Davis sextants.

#025

Davis 
Davis Instruments

3465 Diablo Ave., Hayward, CA 94545 U.S.A.
Phone (510) 732-9229 • Fax (510) 732-9188
info@davisnet.com www.davisnet.com