

DAVIS

Master Sextants

User's Guide

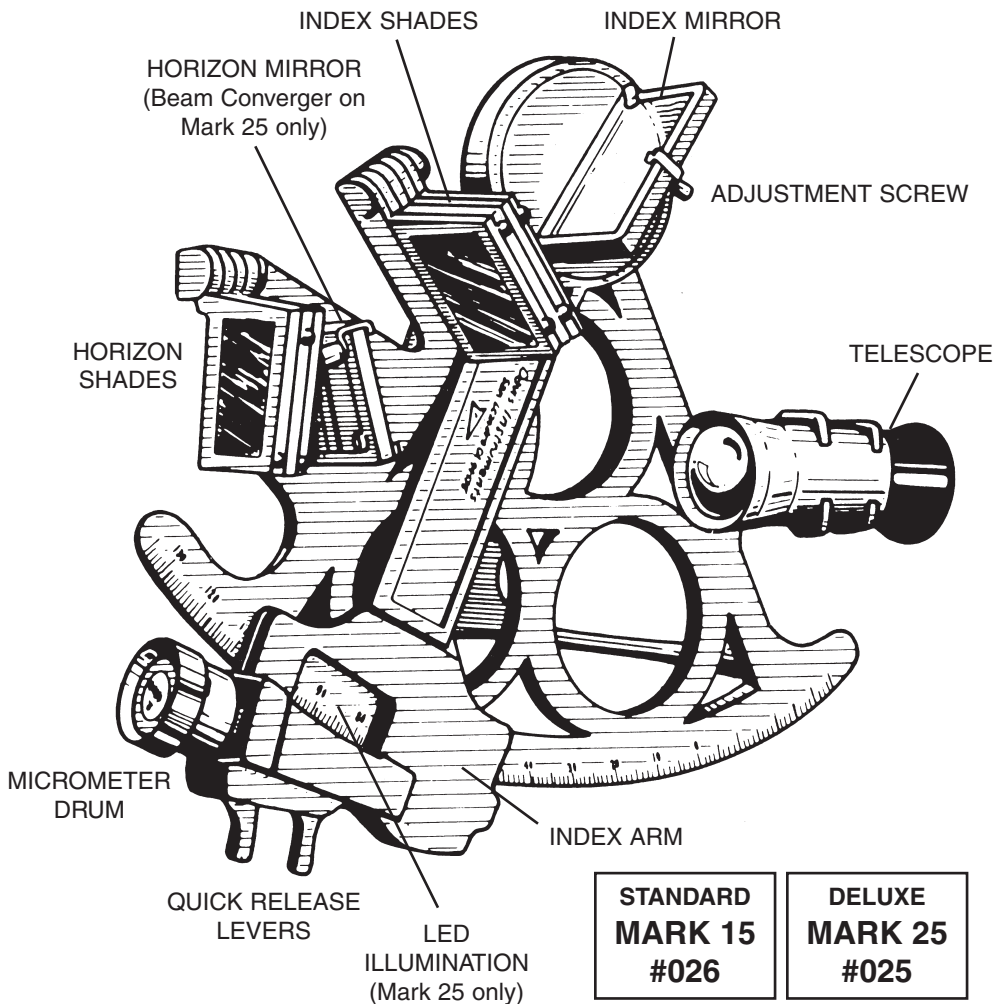

**STANDARD
MARK 15
#026**

**DELUXE
MARK 25
#025**

Replacement Parts

Contact your local dealer or Davis Instruments to order replacement parts or factory overhaul.

Mark 25 Sextant, product #025

R014A	Sextant case
R014B	Foam set for case
R025A	Index shade assembly (4 shades)
R025B	Sun shade assembly (3 shades)
R025C	3× telescope
R026J	Extra copy of these instructions
R025F	Beam converger with index mirror, springs, screws, nuts
R025G	Sight tube
R026D	Vinyl eye cup
R026G	8 springs, 3 screws, 4 nuts
R025X	Overhaul

Mark 15 Sextant, product #026

R014A	Sextant case
R014B	Foam set for case
R026A	Index shade assembly (4 shades)
R026B	Sun shade assembly (3 shades)
R026C	3× telescope
R026D	Vinyl eye cup
R026G	8 springs, 3 screws, 4 nuts
R026H	Index and horizon mirror with springs, screws, nuts
R026J	Extra copy of these instructions
R026X	Overhaul
R026Y	Sight tube

Master Sextants User's Guide

Products #025, #026

© 2008 Davis Instruments Corp. All rights reserved.

00026.710, Rev. F October 2008

USING YOUR DAVIS SEXTANT

This booklet gives the following information about your new Davis Sextant:

- **Operating the sextant**
- **Finding the altitude of the sun using the sextant**
- **Using sextant readings to calculate location**
- **Other uses for the sextant**

To get the most benefit from your sextant, we suggest you familiarize yourself with the meridian transit method of navigation. A good basic reference book is *Practical Celestial Navigation* by Susan P. Howell (Mystic Seaport Publications, 1987). Further discussion of this method of navigation is beyond the scope of this booklet.

OPERATING THE SEXTANT

There are three steps to adjusting your sextant: index mirror adjustment, horizon mirror adjustment, and index error adjustment and calculation. The index arm of the sextant can move in relation to the body by turning the micrometer drum or by squeezing the spring-loaded quick release levers. The levers free the fine adjustment screw in the interior of the index arm and allow it to be moved quickly to any angle. Be sure to squeeze the levers completely so that the screw clears the gear rack on the underside of the sextant. Release the levers and turn the micrometer drum at least one full turn to ensure that the screw has meshed fully with the gear rack. An incorrect reading may be obtained at the drum if this is not done.

Note: Every sextant exhibits some difference in readings when turning toward higher or lower angles (called backlash error). Always make the final movement of the knob toward a higher angle.

Reading the Sextant Scales

The Davis Mark 15 and Mark 25 sextants have three scales that give readings to 2/10 of a minute. The scale on the frame is called the “arc”; each division of the arc equals one degree.

To read the number of degrees:

Find the lines on the arc that are closest to the index line on the index arm.

The index line is usually somewhere between two lines. The correct reading is usually that of the lower value, i.e., the line to the right of the index line.

Note: When the index line is very close to a line on the arc, check the reading at the micrometer drum to be sure that you have taken the correct whole degree.

To read fractions of a degree:

Use the two scales involving the micrometer drum at the side of the index arm.

The outer revolving drum scale indicates minutes of arc (one minute equals $1/60$ of a degree), while the stationary vernier reads to $2/10$ of a minute.

To read the number of minutes:

Find the single **LONG** line at the top of the vernier.

The line on the drum scale that is opposite this line gives the number of minutes. If the line on the vernier is between two lines on the drum, choose the line of lower value.

To read fractions of a minute:

1. Find the **SHORT** line of the vernier that is opposite to a line on the drum.
2. Count the number of spaces this line is away from the long line at the top of the vernier. Each one equals $2/10$ of a minute.

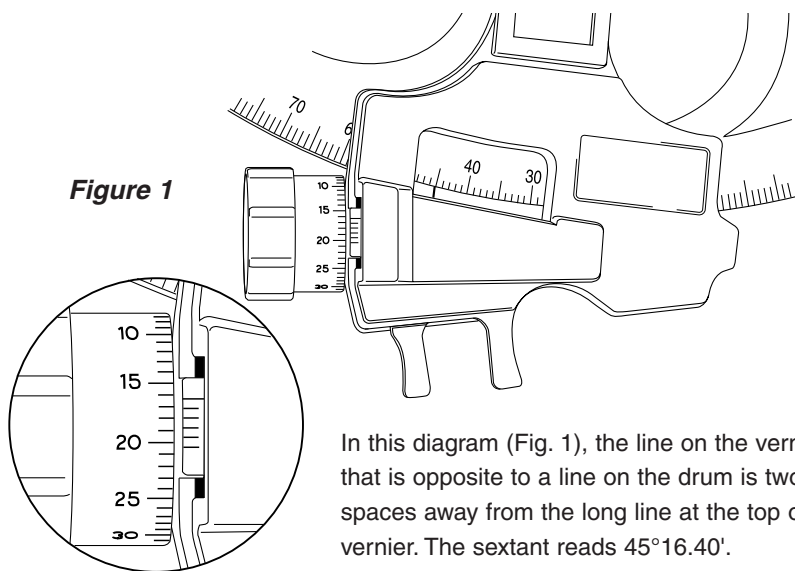

In this diagram (Fig. 1), the line on the vernier that is opposite to a line on the drum is two spaces away from the long line at the top of the vernier. The sextant reads $45^{\circ}16.40'$.

Note: The micrometer drum scale and its screw mechanism, not the arc, determine the accuracy of your sextant. The arc is stamped with sufficient accuracy to ensure that you are never reading the incorrect whole degree; full accuracy in minutes of arc depends exclusively on the drum scale. For example, when the sextant reads $0^{\circ}00'$, the drum scale will be set precisely at zero, while the index line and the zero on the arc may be slightly out of alignment. As you are concerned only with reading whole degrees on the arc, this difference is not significant.

Using the Light on the Davis Mark 25 Sextant

The Mark 25 is specially constructed with a solid state light emitting diode (LED) and light guide to allow easy reading of the scales at twilight.

To use the light:

Make sure that your eyes are dark-adapted before using the light.

Press the button at the top of the handle.

The light turns off when the button is released.

Note: The high-efficiency LED configuration was developed to insure long battery life (as much as ten times longer than with regular bulbs). Nevertheless, all batteries eventually run down. When not using your sextant for long periods of time, remove the batteries by unscrewing the black plastic screw in the handle. Battery contacts can be easily cleaned with a small file or knife blade. Replacements, if needed, are ordinary zinc-carbon or alkaline batteries, 1.5 volt, size AAA. Batteries that start to leak should be removed immediately. After replacing the batteries, be sure to fit the handle together again carefully, and replace the screw snugly but not too tight.

Inserting the 3X Telescope

Your sextant comes equipped with a high quality 3X telescope. The scope is interchangeable with the hooded sight tube.

To remove the sight tube from its mounting bracket on the sextant:

Separate the tube from the eye-piece as shown in Fig. 2 below.

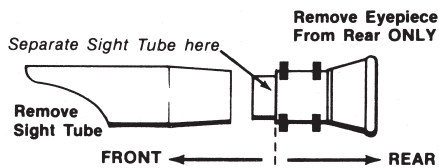
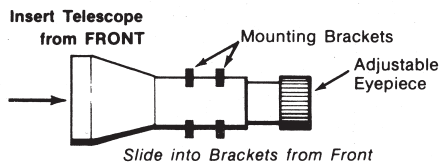

Figure 2



CAUTION: Do not attempt to snap the assembled sight tube into or out of the mounting bracket. Separate the sight tube from the eyepiece by carefully sliding the eyepiece out of the bracket and from the rear only. Insert the scope from the front only.

Adjusting for and Calculating Built-In Index Error

Adjusting your sextant is easy and should be done each time it is used. On a correctly adjusted sextant, the two mirrors are always perpendicular to the frame and become parallel to each other when the body and drum scales read zero.

To initially adjust the index mirror so that it is perpendicular to the frame:

1. Set the instrument at approximately 50° .
2. Holding the sextant horizontal and about eight inches from the eye, look with one eye into the mirror so that the frame arc is reflected in the mirror.
3. Move the instrument until you can look past the index mirror and see the actual frame arc as well as the reflected arc.

The two arcs should appear as one continuous curve (Fig. 3). If they do not, turn the adjustment screw at the back of the index mirror until the two arcs come into alignment.

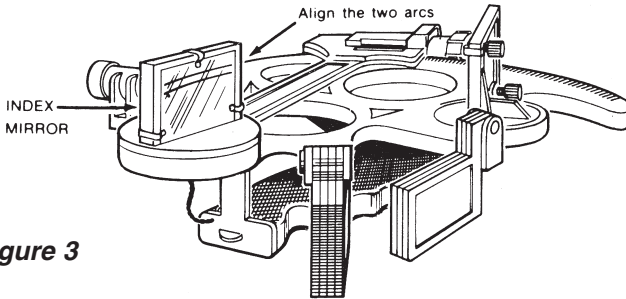

Figure 3

To adjust the sextant for index error:

1. Set the instrument at $0^\circ 00'$ and look at the horizon.
2. Keeping the sextant close to your eye, turn the screw that is furthest from the frame at the back of the horizon mirror until the two horizon images move exactly together (Fig. 4).

The two mirror are now parallel.



Figure 4

3. To be certain that the sextant is now correctly adjusted, check to see that the sextant is still set at $0^{\circ} 00'$ and the real and reflected horizons remain in a single line when the instrument is rocked or inclined from side to side (Fig. 5).

On a correctly adjusted sextant, the real and mirror horizons remain in a single line when the instrument is rocked from side to side.

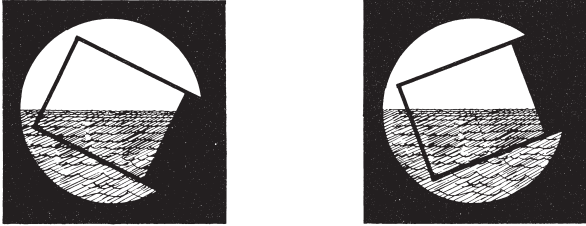

Figure 5

While you should know how to adjust your sextant for index error, it is not necessary to remove it entirely. It is standard practice to simply note the error and then correct one's readings for this amount each time the sextant is used (6' or so of index error is allowable).

To calculate the index error:

1. Hold the sextant in your right hand and look at the sea horizon.
2. By moving the index arm and the micrometer drum, line up the real and mirror horizons so that both appear as a single straight line.
3. Read the sextant scales.

If the sextant reads $0^{\circ} 00'$, there is no index error. If the sextant reads anything but zero, there is an index error, which must be added to or subtracted from each subsequent sight.

For example:

If the sextant reads 6', the 6' is subtracted; if the sextant reads $-6'$, the 6' is added. For an index error of $-6'$, the micrometer drum will read $54'$.

To adjust the horizon mirror (Mark 15 only):

1. **Adjust the horizon mirror (the small, half-silvered mirror) for “side error” by making it perpendicular to the frame.**
2. **Holding the sextant in your right hand, raise the instrument to your eye.**
3. **Look at any horizontal straight edge (the sea horizon or the roof of a building, for example) and move the index arm back and forth.**

The real horizon will remain still while the mirror horizon will appear only when the body and drum scales read close to zero.

4. **Line up the mirror horizon and the real horizon so that both appear as a single straight line (Fig. 6).**



Figure 6

5. **Without changing the setting, look through the sextant at any vertical line (a flagpole or the edge of a building, for example) and slowly swing the instrument back and forth across the vertical line.**

If the horizon mirror is not perpendicular to the frame, the line will seem to jump to one side as the mirror passes it. To correct this, slowly tighten or loosen the screw closest to the frame at the back of the horizon mirror until the vertical line no longer appears to jump (Fig. 7).



Figure 7

To adjust the Beam Converger™ horizon mirror (Mark 25 only):

- 1. Adjust for side error by making the Beam Converger perpendicular to the frame.**
- 2. Holding the sextant in your right hand, raise the instrument to your eye.**
- 3. Look at any horizontal straight edge (the sea horizon or the roof of a building, for example) and move the index arm back and forth using the quick release levers.**

The real horizon will remain still while the reflected horizon will appear only when the arc and drum scales read close to zero.

- 4. Line up the reflected horizon and the real horizon with the knob so that both appear together as a single straight line (Fig. 8).**

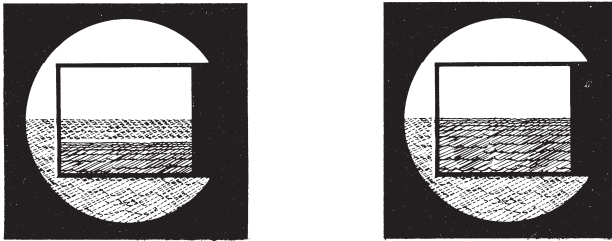

Figure 8

- 5. Without changing the setting, look through the sextant at any vertical line (a flagpole or the edge of a building, for example) and slowly tighten or loosen the screw closest to the frame at the back of the Beam Converger, until the real and reflected vertical lines perfectly coincide (Fig. 9).**

This is particularly easy since the two images have different colors. It is simply a matter of putting one image exactly on top of the other.

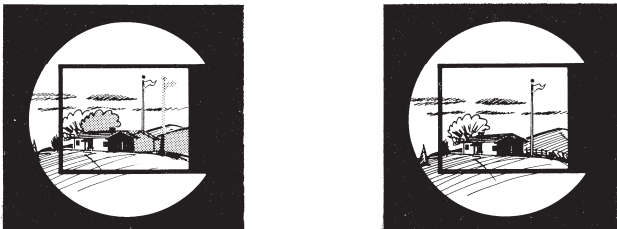

Figure 9

FINDING THE ALTITUDE OF THE SUN USING THE SEXTANT

Before looking at the sun through your sextant, be sure to position a sufficient number of index shades (the large set of four shades) between the two mirrors to protect your eyes from the direct rays of the sun. Choose whatever combination of shades gives you a clear image of the sun without glare.

To Measure the Sun's Altitude:

1. Use index shades to protect your eyes, as discussed above.
2. Use the horizon shades to darken the clear section of the horizon mirror so that it acts as a semi-mirror.
The horizon will still be visible through it, but the sun's image will be reflected.
3. Stand facing the sun with the sextant in your right hand.
4. With your left hand on the quick release levers of the index arm, look through the eyepiece at the horizon and move the index arm until the sun is visible through the two mirrors and index shades.
5. Release the levers and, while slowly rocking the entire sextant from side to side, use the fine adjustment drum to bring the sun's image down to just touch the horizon with its lower edge (lower limb).

The sun's image should travel a short arc that is made to touch the horizon (Fig. 10).

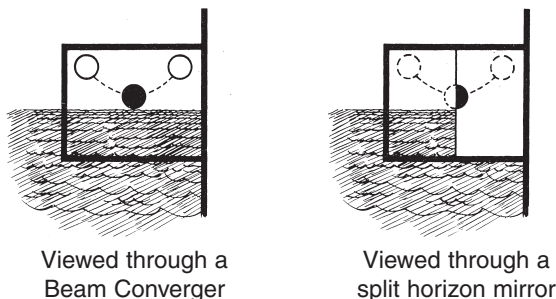

Figure 10

The sun's image travels in an arc that just touches the horizon.

Note: For comparison purposes, the sun's image and horizon are also illustrated as viewed using a Beam Converger, instead of a half-silvered horizon mirror.

6. Read the sun's altitude from the scales on the sextant, being careful not to disturb the setting.

Since all calculations in the Navigation Tables use the center of the sun or moon, this lower limb reading must be adjusted for semi-diameter correction, as shown later.

Correcting for the Height of the Eye

When measuring the altitude of the sun, you need to measure the angle formed by a ray from the sun and a plane tangent to the earth at the point where the observer is standing. However, due to the height of the eye of the observer, the visible horizon actually falls below this theoretical place (Fig. 11). This requires that a “dip correction” be made.

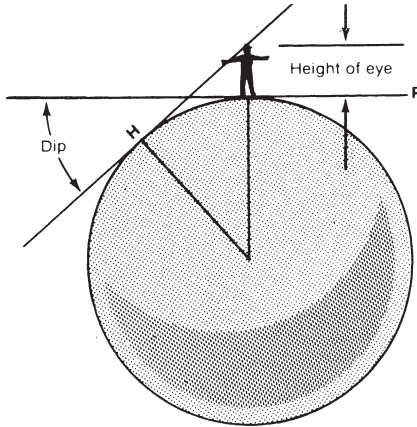

Figure 11

Due to the height of the eye of the observer, the visible horizon (H) falls below the plane tangent to the earth at the point where the observer is standing (P).

To apply a “dip correction” for the height of the eye:

Apply a correction as shown in the table below. Dip correction increases as the eye is raised further above the surface of the water.

Height of Eye	Dip Correction
5 ft. (1.5 m)	2'
10 ft. (3.0 m)	3'
15 ft. (4.5 m)	4'
25 ft. (7.5 m)	5'
40 ft. (12.0 m)	6'

Dip correction must always be subtracted from the sextant reading.

USING SEXTANT READINGS TO CALCULATE LOCATION

Before attempting to calculate your location using readings from your sextant, you need to be familiar with the following concepts:

- **A GREAT CIRCLE is a circle on the surface of the earth, the plane of which passes through the center of the earth.**

The equator and the meridians (perpendicular to the equator) are great circles. See Fig. 12.

- **A SMALL CIRCLE is one whose plane does NOT pass through the center of the earth.**

Parallels of latitude are small circles which become progressively smaller as the distance from the equator increases. At the poles (90° N or 90° S), they are single points.

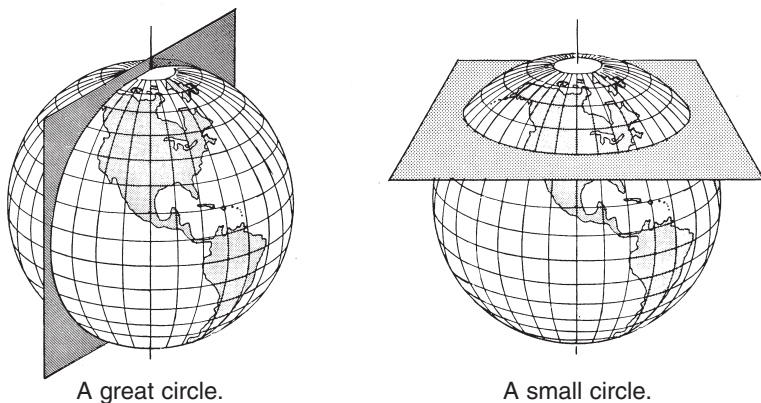

Figure 12

- **A NAUTICAL MILE is equal to one minute of arc of a great circle.**

Latitude is measured north or south from the equator along a meridian (a great circle). One minute of latitude equals one nautical mile anywhere on the earth. **Longitude** is measured east or west from the prime meridian (zero degrees) at Greenwich, England. It is measured along a parallel of latitude (a small circle). One minute of longitude equals one nautical mile only at the equator. Approaching the poles, one minute of longitude equals less and less of a nautical mile (Fig. 13).

Note: The nautical mile (6076 feet; 1852 meters) is longer than the statute mile used on land (5280 feet; 1609 meters). The earth measures 21,600 nautical miles in circumference.

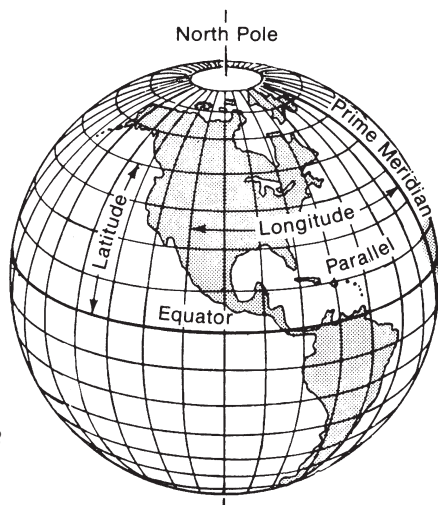

Figure 13

Finding Local Noon and the Sun's Altitude at the Meridian Passage

A meridian is an imaginary line drawn on the earth's surface from pole to pole. A local meridian is one which passes through the position of the observer. When the sun crosses the local meridian, it is at its highest point. It is said to be in meridian passage and the time is local noon. Local noon may vary a half an hour (and in daylight savings time, one and one-half hours) from the noon shown on the clock, due both to the equation of time (to be discussed later) and the fact that our clocks are set to zone time. All clocks in a zone 15° wide show the same time.

To find local noon:

- 1. Follow the sun up with a series of sights, starting about half an hour before estimated local noon.**
- 2. Note the time and the sextant reading carefully.**
- 3. Take a sight about every three minutes until the sun's altitude is no longer increasing.**

During meridian passage, the sun will seem to "hang" in the sky for a short period at its highest point, going neither up nor down.

- 4. Carefully note the sextant reading.**

This is the sun's altitude at meridian passage.

- 5. To determine the exact time of local noon, set your sextant at the same altitude as your first sight. Wait for the sun to drop to this altitude, and note the time again.**

The time of local noon is exactly half way between the times of the two sights.

To locate your position:

Record the local time and the sextant reading when the sun was at the highest point.

These two readings will serve to locate your position. The time is used to determine longitude and the sextant reading to determine latitude.

Calculating the Declination of the Sun

Every star and planet, including the sun, has a ground position, i.e., the spot on the earth directly beneath it. Standing at the sun's G.P. (ground position), you would have to look straight up to see the sun; if you were to measure its altitude with a sextant, you would find the altitude was 90° .

From the earth, the sun seems to move across the sky in an arc from east to west. During certain times of the year, it is "moving" around the earth directly above the equator. In other words, the sun's G.P. is running along the equator. Declination of the sun at this time is zero. However, the sun's G.P. does not stay at the equator throughout the year. It moves north to a maximum of 23.5° N in the summer of the Northern Hemisphere and south to a maximum of 23.5° S in the winter. The distance of the sun's G.P. from the equator, expressed in degrees north or south, is known as the **declination of the sun** (Fig. 14).

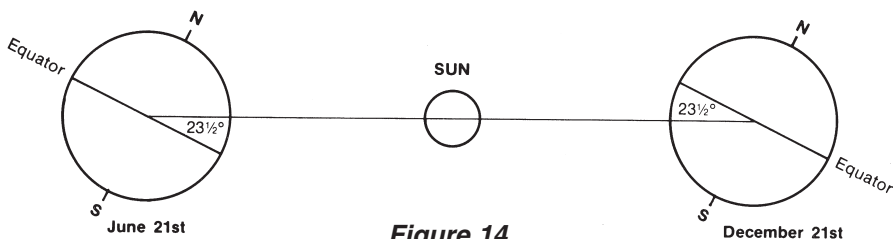

Figure 14
Declination of the Sun

In like manner, each star has a ground position and a declination. The declination of Polaris is $89^\circ 05'N$; it is nearly directly above the North Pole. In the Northern Hemisphere, you can find your approximate position by taking a sight on Polaris. The reading will vary depending upon the time of night, but will never be more than 55 miles off. This is a useful check each evening; the altitude of Polaris will be your approximate latitude without adding or subtracting anything. If you were to find the altitude of Polaris in the evening and again at dawn, your true latitude would be between the two measurements, providing you did not change latitude between the two sights. It is, of course, possible to calculate one's exact latitude from Polaris with the aid of the Nautical Almanac, but such a discussion is beyond the scope of this booklet.

To find Polaris:

1. Locate the pointers of the Big Dipper (Fig. 15).

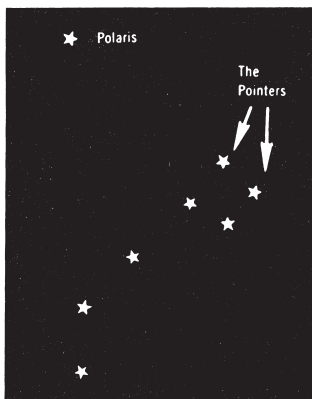

Figure 15

2. Find a point in line with the pointers and five times the distance between them.

Polaris is the star shining above.

Note: The Big Dipper revolves around Polaris so be prepared to see the star cluster in any position.

The Complete Sight: An Example

Let us assume for this example that your ship is sailing from San Francisco to Hawaii and you have been using the sun to find your position each day. To allow plenty of time to follow the sun up to its highest point, make sure that you have completed all your preparations by 10:00 a.m. local time. Your chart shows yesterday's position. From this position, draw a line in the direction you are traveling equal in length to the estimated number of miles to be traveled by noon today. This is your "dead reckoning position" (D.R.), which will be compared with your "noon sight."

Note: You will be standing on deck in such a manner that your eye is ten feet above the water (for Dip correction) and the index error of your sextant is + 5'. At about 11:20 a.m., you begin taking sights. At 11:23:30, your first sextant reading is $82^{\circ} 56'$. You continue recording the sun's altitude approximately every three minutes until the sun seems to "hang" in the sky, dropping to a lower altitude at your next sight. The maximum altitude of the sun, $84^{\circ} 56'$, is the altitude of the sun at meridian passage. You continue taking sights until 12:03:30, when the sun has dropped to your original reading of $82^{\circ} 56'$. You now know that the sun reached its meridian at 11:43:30 (exactly half the time between 11:23:30 and 12:03:30).

Next, you find the Greenwich Mean Time (GMT) of your local noon by listening to the radio time signal, correcting any error you watch may have had. In this example, you tune in the time signal and find that GMT is now 22:10:00. Your watch reads 12:10:00, so it has no error. You now know that your local noon occurred at GMT 21:43:30 (26 minutes 30 seconds ago).

You can now work out your noon sight: the date, the time of meridian passage (local noon), the altitude of the sun at meridian passage, the height of your eye above the surface of the sea, and the index error of the sextant you are using.

Finding Longitude

Meridians of longitude are measured east or west from the prime meridian (zero degrees) at Greenwich, England. Because the ground position of the sun moves around the earth at an average speed of 15° per hour (15 nautical miles per minute), longitude may be calculated by comparing local noon with Greenwich Mean Time (refer to Fig. 13, longitude).

For example: If local noon occurred at 2:00 GMT, your longitude is approximately 30° west of Greenwich (2 hours x 15°/hour = 30°).

While the method already described gives your approximate location, you must apply the equation of time to determine your exact position. The earth in its orbit around the sun does not travel at a constant speed. Clocks and watches, therefore, keep the time of a fictitious or mean sun which travels at the same average speed throughout the year. Furthermore, the position of the true sun (as seen from the northern half of the earth) is not always due south or 180° true at noon by the clock. The difference in time between the true sun and the mean sun is called the “equation of time.” The equation of time for any given day may be found in a Nautical Almanac. An approximate value may be found in the student tables at the end of this booklet.

Example: Longitude Calculation —2 June

21 h 43 m 30s	GMT of local noon (from observation above)
- 12 h 00 m 00s	Greenwich noon
<hr/>	
09 h 43 m 30s	Time from Greenwich to your ship
x 60	Minutes/hour conversion
<hr/>	
583.5m	Minutes from Greenwich to your ship
x 15	G.P. of sun travels 15 minutes of arc/minute of time
<hr/>	
8752.5m	Minutes of arc (nautical miles) from Greenwich
÷ 60	Minutes/degree conversion
<hr/>	
145° 52.5'W	Longitude position of mean sun
+ 33'.0W	Equation of time for 2 June (from student tables)
<hr/>	
146° 25.5'W	Longitude of observer

Finding Latitude

The altitude of the sun at local noon may also be used to calculate latitude.

To calculate latitude:

1. Correct the measured altitude for index error, height of eye, refraction, and semi-diameter.

Refraction correction is negligible for altitudes above 25°.

Semi-diameter correction averages + 0° 16' (semi-diameter correction adjusts the sextant reading from an observation of the lower limb of the sun to one of the center of the sun; 16' equals one-half of the sun's diameter).

2. After the corrections are made, determine the declination of the sun from the Nautical Almanac or from the approximate declination values at the end of this booklet.

3. Calculate latitude by combining the altitude of the sun at local noon with the declination of the sun from the navigation tables. Assuming you are north of the sun, the following formula is used in northern latitudes:

$$\text{Latitude} = 90^\circ - \text{Corrected Altitude} \pm \text{Declination of the Sun}$$

When the sun is north of the equator, ADD the declination; when it is south of the equator, SUBTRACT the declination.

Example: Latitude Calculation Latitude—2 June

1. Find the corrected altitude of the sun.

hs	84° 56'	Lower limb observation (your sextant reading at local noon)
-IC	5'	Index correction
	<u>84° 51'</u>	
-DIP	3'	Height of eye correction (see Fig. 11)
	<u>84° 48'</u>	
+ 16'	16'	Semi-diameter correction
	<u>85° 04'</u>	Corrected altitude

2. Apply the above formula for latitude.

	89° 60'	Altitude of the sun at G.P. (89° 60' = 90°)
-Ho	<u>85° 04'</u>	Corrected altitude of the sun (from "Step One" above)
	4° 56'	Distance from the sun's G.P.
+ 22° 08'N	<u>27° 04'N</u>	Declination of the sun, north of the equator on June 2
		Latitude of observer

Diagrams of longitude and latitude calculations

The presentations here are commonly used by navigators to help insure the accuracy of their calculations.

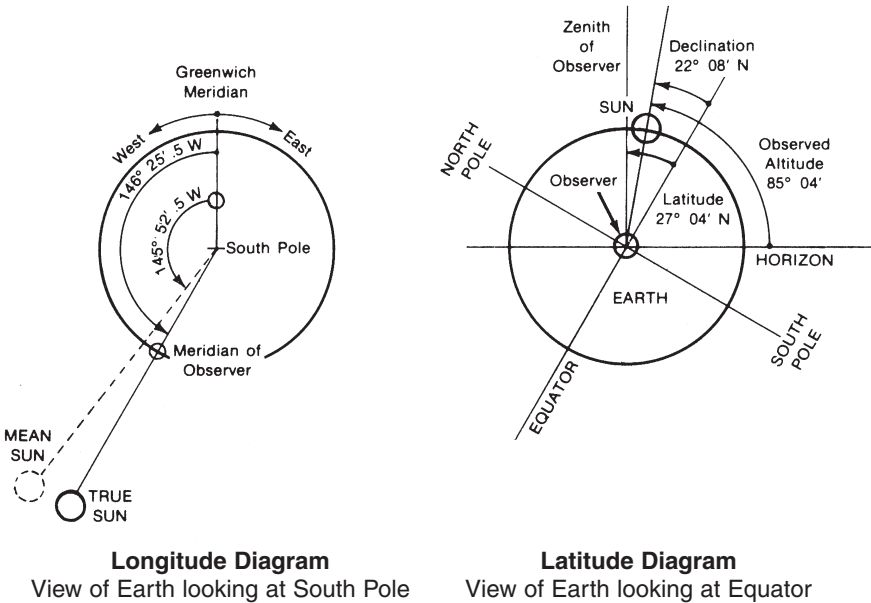

Figure 16

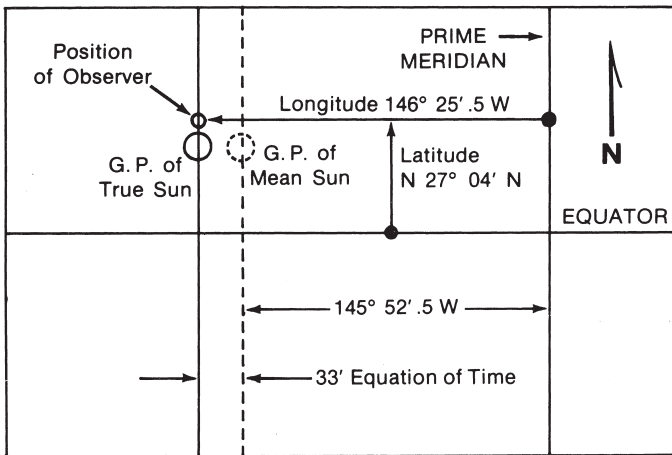

Figure 17
Position Plot on Chart

Calculating Position Using Celestial Navigation

The method already described for calculating your position is the oldest method used since the introduction of the chronometer. Please note;

- **Latitude can be determined at noon if you know the corrected altitude of the sun and its declination.** You don't need to know the time. The accuracy of your calculation is limited only by the accuracy of measurement of the sun's altitude and by the accuracy of the declination tables.
- **Longitude can be determined if you know both the time of observation and the equation of time.** While your sextant gives highly accurate measurements, practical difficulties inherent in this method normally preclude accuracy of more than 10' of longitude.

A generalized system of position determination which enables you to use observation of the sun and other celestial bodies made at time other than noon requires knowledge of the navigation triangle, circles of equal altitude, assumed position, and associated navigation tables such as the Nautical Almanac and Sight Reduction Tables. These systems of celestial navigation are thoroughly studied and extensively used by serious navigators throughout the world.

Note: Work forms and sight reduction tables are available from publishers, typically with step-by-step instructions. Nearly all navigators use work forms such as these to prevent errors and omissions in the calculation of celestial navigation problems.

Working with an Artificial Horizon

At times, it is not possible to see the natural horizon. Sun or moon shots may still be taken, with the aid of an artificial horizon—a simple device containing water or oil shielded from the wind (Fig. 18). It may be used by individuals exploring inland far from the sea, or by students or experienced navigators to practice celestial navigation without traveling to large bodies of water.

To use the artificial horizon:

1. **Position the artificial horizon on level ground or other steady place.**
One end of the artificial horizon should face directly into the sun so that a shadow is cast at the opposite end. The sides and end facing the sun should be shadow-free.
2. **Looking into the center of the liquid, move your head about so that you can see the sun reflected on the liquid surface.**
3. **Bring the sextant to your eye and move the index arm of the sextant until you see two suns—on reflected on the liquid and a double-reflected image on the mirrors.**

4. **Line the two suns up by continuing to move the index arm.**
For a lower limb observation, bring the bottom of the mirror image into coincidence with the top of the image on the liquid.
5. **After the observation has been made, apply the index correction.**
6. **Halve the remaining angle and apply all other corrections (except for Dip or height of eye correction, which is not applicable) to find the altitude of the sun.**

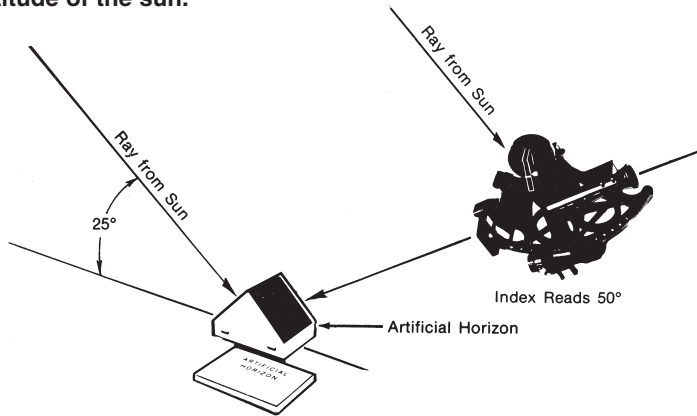

Figure 18

Note: Since the sextant reading made with an artificial horizon must be halved, the maximum altitude that you can observe with the artificial horizon is equal to one-half the maximum arc graduation on your sextant. There may be several hours around noon during which the sun is too high to take a sextant reading with the artificial horizon, so plan sights for the morning or evening hours.

OTHER USES for the SEXTANT

Using the Sextant as a Pelorus

A pelorus is used to take bearings relative to your ship's heading.

1. **Pick out three features on the land.**
2. **With the sextant held horizontally, measure the angle between the center feature and one of the other features, and note the angle on a piece of paper.**
3. **As quickly as you can, measure the angle between the center feature and the third feature.**
4. **Lay out the three angles on a piece of tracing paper so that the angles have a common center point.**

5. Move the tracing paper around on the chart until the lines are positioned so as to run through the three features.

The point of intersection of the three angles is your position (Fig. 19).

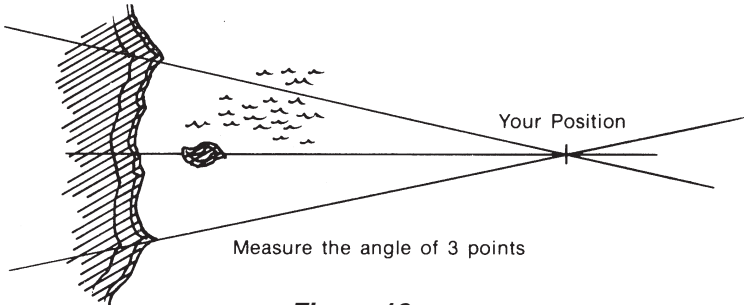

Figure 19

Note: Since the sextant does not have a compass, you do not need to worry about variation or deviation. You must use at least three lines of position, however.

Using the Sextant as a Heliograph

You can use the sextant mirror to flash the sun's rays several miles to attract attention, or to signal another person who is too far away for your voice to reach. If you know Morse code, you could even send a message.

1. Hold the sextant so that the index mirror (the larger of the two mirrors) is just below the eye.
2. With your other arm extended and the thumb held upright, look at the person you wish to signal.
3. Hold your thumb to a position just below the person, so that your eye (with the mirror under it), your thumb, and the person are in a straight line (Fig. 20).
4. Using the mirror, flash the sun on your thumb.
The sun flashes simultaneously on the distant person.

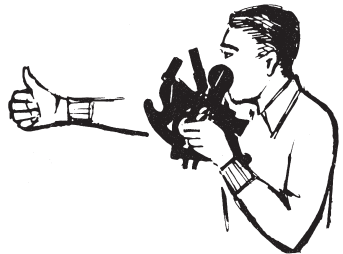

Figure 20

REFERENCE:

Approximate Declination & Equation of Time

The following tables give the approximate declination and equation of time of the sun. Latitude calculated with these values will be accurate to about $\pm 15'$.

The tables are for study purposes only.

	<u>JANUARY</u>		<u>FEBRUARY</u>		<u>MARCH</u>		<u>APRIL</u>	
	DEC	Eq	DEC	Eq	DEC	Eq	DEC	Eq
1	23° 01S	E0° 54'	17° 12S	E3° 24'	7° 44S	E3° 09'	4° 23N	E1° 01'
2	22° 56S	E1° 00'	16° 54S	E3° 27'	7° 19S	E3° 06'	4° 49N	E0° 57'
3	22° 51S	E1° 08'	16° 36S	E3° 29'	6° 57S	E3° 03'	5° 11N	E0° 53'
4	22° 47S	E1° 15'	16° 20S	E3° 30'	6° 35S	E2° 59'	5° 35N	E0° 48'
5	22° 38S	E1° 18'	16° 00S	E3° 31'	6° 11S	E2° 55'	5° 56N	E0° 43'
6	22° 33S	E1° 28'	15° 44S	E3° 31'	5° 47S	E2° 53'	6° 20N	E0° 39'
7	22° 26S	E1° 35'	15° 25S	E3° 31'	5° 24S	E2° 50'	6° 44N	E0° 34'
8	22° 17S	E1° 38'	15° 05S	E3° 32'	5° 02S	E2° 46'	7° 05N	E0° 30'
9	22° 10S	E1° 45'	14° 47S	E3° 33'	4° 37S	E2° 42'	7° 25N	E0° 25'
10	22° 01S	E1° 52'	14° 26S	E3° 34'	4° 14S	E2° 38'	7° 50N	E0° 23'
11	21° 50S	E1° 58'	14° 08S	E3° 35'	3° 53S	E2° 33'	8° 11N	E0° 18'
12	21° 42S	E2° 02'	13° 49S	E3° 33'	3° 26S	E2° 31'	8° 35N	E0° 14'
13	21° 33S	E2° 08'	13° 28S	E3° 34'	3° 03S	E2° 26'	8° 54N	E0° 11'
14	21° 21S	E2° 16'	13° 10S	E3° 34'	2° 41S	E2° 21'	9° 17N	E0° 06'
15	21° 11S	E2° 21'	12° 49S	E3° 34'	2° 51S	E2° 17'	9° 40N	E0° 03'
16	21° 00S	E2° 27'	12° 25S	E3° 34'	1° 51S	E2° 14'	10° 00N	W0° 01'
17	20° 47S	E2° 32'	12° 08S	E3° 32'	1° 30S	E2° 09'	10° 23N	W0° 04'
18	20° 36S	E2° 37'	11° 44S	E3° 31'	1° 05S	E2° 08'	10° 44N	W0° 09'
19	20° 25S	E2° 41'	11° 25S	E3° 30'	0° 43S	E2° 01'	11° 03N	W0° 12'
20	20° 12S	E2° 46'	11° 02S	E3° 29'	0° 17S	E1° 56'	11° 22N	W0° 15'
21	19° 57S	E2° 49'	10° 43S	E3° 27'	0° 05N	E1° 51'	11° 43N	W0° 18'
22	19° 44S	E2° 54'	10° 20S	E3° 26'	0° 31N	E1° 47'	12° 05N	W0° 21'
23	19° 31S	E2° 59'	9° 56S	E3° 23'	0° 54N	E1° 42'	12° 26N	W0° 24'
24	19° 18S	E3° 01'	9° 33S	E3° 21'	1° 18N	E1° 38'	12° 43N	W0° 27'
25	19° 04S	E3° 07'	9° 12S	E3° 17'	1° 04N	E1° 33'	13° 06N	W0° 30'
26	18° 50S	E3° 10'	8° 47S	E3° 16'	2° 03N	E1° 29'	13° 24N	W0° 33'
27	18° 32S	E3° 12'	8° 30S	E3° 14'	2° 27N	E1° 24'	13° 44N	W0° 35'
28	18° 16S	E3° 16'	8° 06S	E3° 10'	2° 50N	E1° 19'	14° 05N	W0° 38'
29	18° 00S	E3° 18'			3° 14N	E1° 15'	14° 20N	W0° 39'
30	17° 46S	E3° 20'			3° 38N	E1° 10'	14° 40N	W0° 42'
31	17° 27S	E3° 23'			4° 00N	E1° 06'		

Equation of Time = True Sun E or W of the Mean Sun

Declination = Sun N or S of the Equator

	<u>MAY</u>		<u>JUNE</u>		<u>JULY</u>		<u>AUGUST</u>	
	DEC	Eq	DEC	Eq	DEC	Eq	DEC	Eq
1	14° 57N	W0° 44'	22° 00N	W0° 36'	23° 06N	E0° 53'	18° 07N	E1° 33'
2	15° 18N	W0° 45'	22° 08N	W0° 33'	23° 03N	E0° 56'	17° 55N	E1° 33'
3	15° 31N	W0° 46'	22° 18N	W0° 16'	23° 01N	E0° 59'	17° 37N	E1° 32'
4	15° 52N	W0° 48'	22° 23N	W0° 28'	22° 56N	E1° 03'	17° 23N	E1° 32'
5	16° 10N	W0° 49'	22° 31N	W0° 27'	22° 49N	E1° 05'	17° 05N	E1° 31'
6	16° 26N	W0° 51'	22° 38N	W0° 23'	22° 45N	E1° 09'	16° 50N	E1° 29'
7	16° 45N	W0° 52'	22° 45N	W0° 21'	22° 37N	E1° 12'	16° 32N	E1° 27'
8	17° 00N	W0° 54'	22° 50N	W0° 18'	22° 32N	E1° 13'	16° 15N	E1° 25'
9	17° 15N	W0° 55'	22° 53N	W0° 15'	22° 25N	E1° 14'	15° 59N	E1° 23'
10	17° 32N	W0° 56'	22° 59N	W0° 12'	22° 19N	E1° 17'	15° 41N	E1° 20'
11	17° 48N	W0° 56'	23° 03N	W0° 09'	22° 11N	E1° 19'	15° 25N	E1° 18'
12	18° 03N	W0° 56'	23° 08N	W0° 06'	22° 01N	E1° 23'	15° 06N	E1° 17'
13	18° 20N	W0° 57'	23° 10N	W0° 03'	21° 54N	E1° 24'	14° 47N	E1° 14'
14	18° 33N	W0° 57'	23° 16N	0° 00'	21° 44N	E1° 25'	14° 29N	E1° 12'
15	18° 46N	W0° 57'	23° 18N	E0° 03'	21° 37N	E1° 26'	14° 12N	E1° 09'
16	19° 03N	W0° 57'	23° 19N	E0° 06'	21° 25N	E1° 27'	13° 51N	E1° 06'
17	19° 16N	W0° 56'	23° 22N	E0° 09'	21° 17N	E1° 29'	13° 35N	E1° 03'
18	19° 27N	W0° 56'	23° 25N	E0° 12'	21° 05N	E1° 30'	13° 15N	E1° 00'
19	19° 41N	W0° 56'	23° 25N	E0° 15'	20° 55N	E1° 32'	12° 54N	E0° 57'
20	19° 53N	W0° 55'	23° 24N	E0° 19'	20° 46N	E1° 33'	12° 37N	E0° 52'
21	20° 06N	W0° 54'	23° 27N	E0° 23'	20° 35N	E1° 35'	12° 15N	E0° 50'
22	20° 19N	W0° 53'	23° 27N	E0° 25'	20° 23N	E1° 36'	11° 58N	E0° 44'
23	20° 30N	W0° 51'	23° 25N	E0° 29'	20° 10N	E1° 37'	11° 36N	E0° 41'
24	20° 43N	W0° 50'	23° 24N	E0° 31'	19° 58N	E1° 37'	11° 16N	E0° 36'
25	20° 53N	W0° 49'	23° 23N	E0° 36'	19° 44N	E1° 36'	10° 54N	E0° 33'
26	21° 03N	W0° 48'	23° 22N	E0° 39'	19° 31N	E1° 36'	10° 35N	E0° 28'
27	21° 15N	W0° 46'	23° 21N	E0° 42'	19° 19N	E1° 36'	10° 14N	E0° 24'
28	21° 24N	W0° 44'	23° 19N	E0° 45'	19° 06N	E1° 35'	09° 53N	E0° 20'
29	21° 33N	W0° 42'	23° 16N	E0° 46'	18° 50N	E1° 35'	09° 30N	E0° 16'
30	21° 43N	W0° 41'	23° 12N	E0° 51'	18° 38N	E1° 35'	09° 11N	E0° 13'
31	21° 50N	W0° 38'			18° 23N	E1° 34'	08° 48N	E0° 08'

	<u>SEPTEMBER</u>		<u>OCTOBER</u>		<u>NOVEMBER</u>		<u>DECEMBER</u>	
	DEC	Eq	DEC	Eq	DEC	Eq	DEC	Eq
1	08° 25N	E0° 02'	03° 00S	W2° 31'	14° 19S	W4° 06'	21° 43S	W2° 43'
2	08° 06N	W0° 01'	03° 25S	W2° 35'	14° 37S	W4° 06'	21° 53S	W2° 41'
3	07° 42N	W0° 06'	03° 48S	W2° 41'	14° 57S	W4° 07'	22° 03S	W2° 35'
4	07° 21N	W0° 12'	04° 10S	W2° 46'	15° 16S	W4° 07'	22° 11S	W2° 30'
5	06° 58N	W0° 18'	04° 34S	W2° 50'	15° 32S	W4° 07'	22° 18S	W2° 25'
6	06° 37N	W0° 23'	04° 56S	W2° 34'	15° 52S	W4° 06'	22° 26S	W2° 19'
7	06° 14N	W0° 28'	05° 20S	W3° 00'	16° 10S	W4° 06'	22° 35S	W2° 12'
8	05° 52N	W0° 32'	05° 44S	W3° 05'	16° 27S	W4° 05'	22° 41S	W2° 04'
9	05° 30N	W0° 35'	06° 07S	W3° 10'	16° 45S	W4° 04'	22° 45S	W2° 00'
10	05° 06N	W0° 42'	06° 30S	W3° 13'	17° 00S	W4° 03'	22° 52S	W1° 53'
11	04° 45N	W0° 49'	06° 52S	W3° 15'	17° 18S	W4° 01'	22° 58S	W1° 44'
12	04° 21N	W0° 54'	07° 15S	W3° 20'	17° 34S	W4° 00'	23° 02S	W1° 39'
13	03° 57N	W0° 58'	07° 37S	W3° 24'	17° 51S	W3° 58'	23° 06S	W1° 32'
14	03° 34N	W1° 03'	07° 58S	W3° 29'	18° 08S	W3° 55'	23° 10S	W1° 25'
15	03° 13N	W1° 09'	08° 20S	W2° 32'	18° 22S	W3° 52'	23° 16S	W1° 17'
16	02° 48N	W1° 15'	08° 45S	W3° 34'	18° 38S	W3° 50'	23° 19S	W1° 10'
17	02° 25N	W1° 21'	09° 06S	W3° 36'	18° 53S	W3° 48'	23° 22S	W1° 03'
18	02° 03N	W1° 24'	09° 30S	W3° 42'	19° 07S	W3° 45'	23° 23S	W0° 56'
19	01° 40N	W1° 31'	09° 45S	W3° 44'	19° 23S	W3° 41'	23° 24S	W0° 48'
20	01° 16N	W1° 31'	10° 12S	W3° 46'	19° 35S	W3° 37'	23° 25S	W0° 41'
21	0° 52N	W1° 41'	10° 33S	W3° 48'	19° 50S	W3° 35'	23° 27S	W0° 33'
22	0° 29N	W1° 47'	10° 55S	W3° 50'	20° 03S	W3° 31'	23° 27S	W0° 24'
23	0° 05N	W1° 52'	11° 15S	W3° 52'	20° 16S	W3° 25'	23° 26S	W0° 18'
24	0° 17N	W1° 56'	11° 35S	W3° 54'	20° 28S	W3° 21'	23° 25S	W0° 11'
25	0° 40S	W2° 01'	11° 58S	W3° 57'	20° 41S	W3° 16'	23° 24S	W0° 02'
26	01° 05S	W2° 08'	12° 16S	W3° 59'	20° 52S	W3° 14'	23° 23S	E0° 04'
27	01° 28S	W2° 11'	12° 36S	W4° 02'	21° 02S	W3° 08'	23° 22S	E0° 12'
28	01° 52S	W2° 16'	13° 00S	W4° 03'	21° 13S	W3° 02'	23° 19S	E0° 19'
29	02° 15S	W2° 21'	13° 20S	W4° 04'	21° 24S	W2° 59'	23° 16S	E0° 26'
30	02° 38S	W2° 28'	13° 39S	W4° 05'	21° 36S	W2° 53'	23° 12S	E0° 35'
31			13° 57S	W4° 06'			23° 07S	E0° 41'

DAVIS 

Davis Instruments

3465 Diablo Ave., Hayward, CA 94545 U.S.A.

Phone (510) 732-9229 • Fax (510) 732-9188

info@davisnet.com www.davisnet.com