

EN

TECHNICAL MANUAL



Dolphin premium

Battery charger

premium 12V60A
399050 - PF.15053

premium 24V30A
PF.16070

SAFETY PRECAUTIONS

NOT-PREMIUM900W-00



TO PREVENT ANY RISK OF ELECTRIC SHOCK OR FIRE, READ THIS MANUAL CAREFULLY BEFORE INSTALLING THE EQUIPMENT.

In the event of any problems or misunderstandings, please contact your dealer.

This equipment is not designed for use by people (including children) with diminished physical, sensorial or mental capacities, or people without experience or knowledge of such equipment, unless they have received prior instruction in the use of the equipment from a person responsible for their safety or are under the supervision of such a person. Ensure that children are supervised in order to prevent them playing with the device.

This equipment contains components that may cause electric arcs or sparks, when connecting cables, for example. To prevent any risk of fire or explosion, do not install this equipment close to flammable materials, liquids or gases.



Installation precautions

To prevent any risk of irreversible damage to the equipment, ensure that you comply scrupulously with the following recommendations.

- ▶ Do not install this device near a heat source.
- ▶ It should not be installed in an airtight or badly ventilated area.
- ▶ All ventilation ducts must be unobstructed.
- ▶ Leave at least 10 cms / three inches clearance around the device for proper ventilation.
- ▶ Mount in a vertical position, to create natural ventilation for the charger. Note that the wiring connections are at the bottom of the charger.

NOT-PREMIUM900W-00

- ▶ All electrical connections to and from the charger must remain accessible at all times.
- ▶ This system should not be exposed to water or dust.
- ▶ It is strictly forbidden to tamper with the system casing in any way.
- ▶ This device is not a toy and must be kept out of the reach of children.



Connection precautions.

To prevent any risk of electric shock or irreversible damage to the equipment, you should comply strictly with the following recommendations.

- ▶ The installation to which this device is connected must comply with the standards currently enforced in the country of use..
- ▶ This device is designed to be connected to 220-240V 50Hz or 110-120V 60Hz single phase circuits. 115V / 230V selection is automatic.
- ▶ In order to protect the occupants, the input point must be attached to a differential circuit breaker. Please refer to the specific characteristics of the circuit breaker.
- ▶ For security reasons, the system's PE terminal must strictly be connected to the installation's Earth (green/yellow wire in the cable section). Please consult the wiring diagram.
- ▶ To prevent overheating, ensure the correct connection and size of cables.
- ▶ The input cable must not exceed 3 meters (10 feet) and the output cable 1.5 meters (5 feet).
- ▶ All cable connections and connectors must be maintained in good condition. Once the connection of the AC cable has been completed,

SAFETY PRECAUTIONS

NOT-PREMIUM900W-00

it is imperative to fit the Winsta Wago snap on security cover. See “Assembling the Shore Power Connector”



Activation precautions

In order to avoid all risk of electric shock or irreversible damage to the device, please follow very carefully the following recommendations.

- ▶ Do not dismantle the device. The housing (protection against fire) must be correctly mounted.
- ▶ This device complies with enforced standards; regarding emitted interference, protection against disturbances of external origins (refer to the paragraph on EMC – Technical Specifications.)
- ▶ When in use, avoid submitting the device to levels of interference, in particular electromagnetic and conducted, superior to those legally permitted (for example, the device installed too close to an emitter) as this may cause irreversible damage.
- ▶ This device emits interference (electromagnetic and conducted) which complies with legal standards. Ensure that materials used are compatible i.e. susceptible, with this device in order to avoid irreversible damage.

Device serial number

The serial number appears on the grey or white sticker on one side of the device. This number is aligned vertically and comprises a first number indicating the year of manufacture (e.g.: 16 for 2016), a letter indicating the month of manufacture (e.g.: C for the month of March), as well as a 5-figure number that is the product’s individual serial number.

**Important
Note on the choice of charge curve**

It is extremely important to choose the correct charging curve, one which is appropriate for the battery's technology. An incorrect choice could cause irreversible damage.

- ▶ This is particularly true for charging curves where the charging voltage is higher than the manufacturers' recommended voltage levels.
- ▶ There is a high risk of overheating and emission of noxious gases
- ▶ Charging curve 4 is compatible with LiFeSo4 batteries that have a BMS (battery management system) installed.
- ▶ It is essential to consult the battery manufacturer's recommendations.

Maintenance precautions

To prevent any risk of electric shock during maintenance operations, ensure that the following recommendations are scrupulously observed before performing any maintenance on the device:

- ▶ This device cannot be dismantled and thus the PC board is inaccessible. It is strictly forbidden to dismantle the housing for any reason. Electric shock possible.
- ▶ In order to prevent risk of electric shocks during maintenance, please follow closely all recommendations below before any maintenance begins.
- ▶ Any operation carried out to this effect must be carried out by an authorized electrician. In the event of damaged wires or cables, these must be replaced by an authorized electrician. The end user must not attempt to change them.

SAFETY PRECAUTIONS

NOT-PREMIUM900W-00



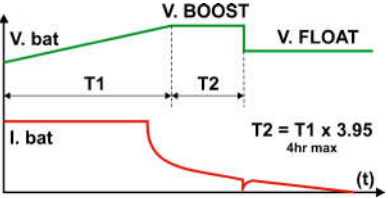

- ▶ The mains and battery connections must be disconnected before any work is carried out in order to avoid transfer of energy
- ▶ Fuses must be replaced by fuses that have the same characteristics and performance levels.

	12V60A	24V30A
INPUT		
Voltage	115V - 230V (+/- 15%)	
Frequency	50Hz - 60Hz (+/- 10%)	
Cos phi	0,9 typ	
Efficiency	80% typ	
Mains consumption	10A	5A
Fuse	T16A 250V 5x20mm	
OUTPUT		
Nb of outputs	3 isolated outputs	
Nb charging curves	4 possible charging curves. Selection by external dip-switch	
Curves types	IUUo	
Charging profile	 <p style="text-align: center;"> $T2 = T1 \times 3.95$ 4hr max </p>	

TECHNICAL SPECIFICATIONS

EN

NOT-PREMIUM900W-00

	12V60A	24V30A
Charging curve 1 Lead open		Battery type: Lead open
		V.boost = 14,2V V.float = 13,2V
Charging curve 2 GEL		Battery type: GEL, AGM, Spiral
		V.boost = 14,2V V.float = 13,7V
Charging curve 3 Lead Calcium		Battery type: Lead Calcium
		V.boost = 14,8V V.float = 13,7V
Charging curve 4 Power Supply or LiFeSo4		Battery type: Power supply or LiFeSo4
		V.boost = 14,2V V.float = 14,2V
Voltage precision	+/- 2%	
Ripple	< 1% pp (BW < 20 MHz)	
Max current	60A	30A
Fuse	3xF25A 32V Automotive	3xF15A 32V Automotive
Protections	Against output overload, output short circuit, excessive internal temperature, excessive battery temperature, output overvoltage, battery reverse polarity (fuse)	
GENERAL		
Display	Front LED or remote TOUCH View (option)	
Operating temp	-10°C à +50°C	
Storage temp	-20°C à +70°C	
Humidity	10% à 90% (without condensation)	
Ventilation	Forced fan cooling	
External com	CANbus	
EMC	EN61000-6-3 et EN61000-6-1	
Security	EN60335-2-29 (2002)	
Housing	White aluminium – wall mounted	
Mounting	3 x 4mm screws	
Dimensions	284 x 240 x 115mm	
Weight	3,1 kg	
Main acces	3 points, 20A 230V, 4mm2 max Réf. : 770.813/G11-000 (WINSTA - WAGO)	
BAT acces	4 points, 60A, 35mm2 max	
TOUCH acces	RJ11, 4 points	
CAN acces	Micro-Fit, 6 points	
UART acces	RJ12, 6 points	

TECHNICAL SPECIFICATIONS

NOT-PREMIUM900W-00

Mode	LED	Status
Absorption	Steady yellow	The batteries are charging. Time required to complete Absorption mode varies depending on the initial status of the batteries, but is limited to 6 hours.
Equalisation	Yellow blinking	The batteries are coming to the end of the charging cycle. Time required to complete Equalization mode, depending on the initial status of the batteries, varies from 30 minutes to 4 hours.
End of Equalisation	Green blinking	The batteries are almost charged. Floating mode will begin in less than 30 minutes.
Floating	Green	The batteries are completely charged.
Internal Temperature fault	Red fixed	The charger is on Standby for a period of between 30 seconds and 10 minutes. Once the fault has been solved, the device will start up again automatically.
Output voltage fault	Red blinking	The charger is on Standby for a period of 30 seconds. Once the fault has been solved, the device will start up again automatically.
Battery fuse fault	Red Flashing	The fuse should be replaced.

CONNECTIONS EN

NOT-PREMIUM900W-00



Front LED

Battery fuses
under the product



- Main acces
- TOUCH view_RJ11
- CANbus_MicroFit
- Cycle charge selector
- UART_RJ12
- BAT acces

CONNECTIONS

NOT-PREMIUM900W-00

Wiring diagram

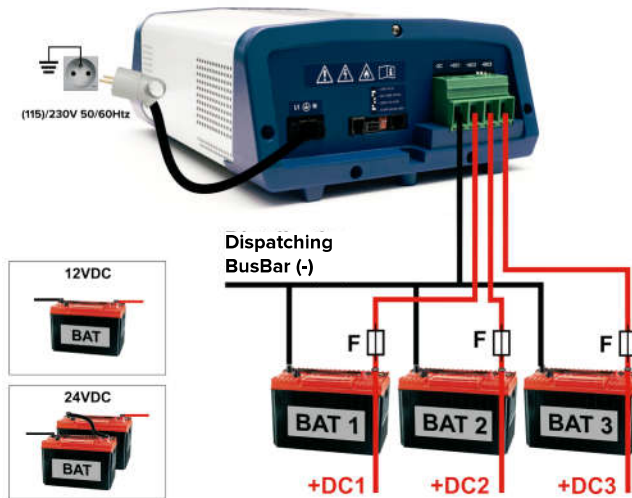

Assembling the shore power connector

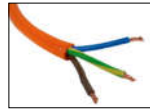

Step 1

Remove approx 3 cm of the outer sheath
Remove approx 8 mm of the inner wires' sheaths
Tinplate the bare copper ends



Step 2

Remove the security cap using an utility knife



Step 3

Pull the conductor through the pre latched strain relief housing



Step 4

Open the clamp with a screwdriver and insert the first cable up to the stop. Repeat this step for all three cables



Step 5

Latch the connector on to the strain relief housing



Step 6

Snap together the upper and lower parts of the strain relief housing and tighten it using the screw

DIMENSIONS

EN

NOT-PREMIUM900W-00

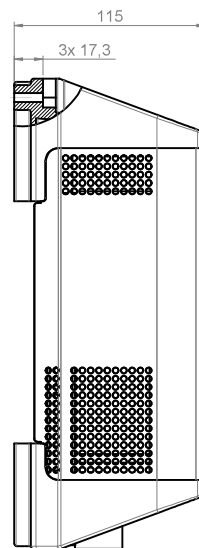
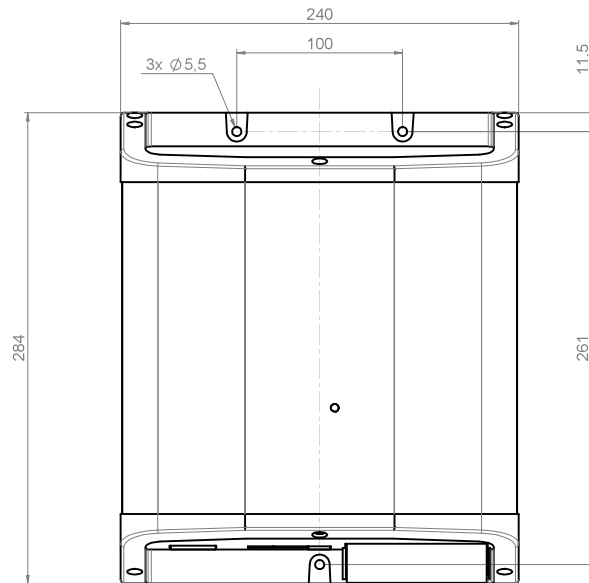

Check that the mounting screws used are compatible with the type of mounting wall (resin, wood, metal, etc.). The charger should be positioned against the wall and mounted firmly.

WARRANTY

NOT-PREMIUM900W-00

Warranty

TO PREVENT ANY RISK OF INCORRECT USE OF THE DEVICE, CAREFULLY READ THE LIST OF POTENTIAL EVENTS OR FAULTS NOT COVERED BY THE PRODUCT WARRANTY

- ▶ This device is not protected against battery polarity reversals. Risk of irreversible damage to the equipment.
- ▶ Should the device be dropped or fall this could cause irreversible distortion of the housing as well as a “crash” of internal fans and certain electronic components.
- ▶ Modifications to the housing (additional holes in particular) could result in the scattering of swarf or metal filings onto the circuit board and, consequently, in malfunctions or irreversible damage to the equipment.
- ▶ Interference with or modifications to the circuit board could result in operating modes not originally anticipated, and consequently, in malfunctions or irreversible damage to the equipment.
- ▶ Powering the device from an unsuitable energy source (as a general rule, mains supply voltage that is too high).
- ▶ Accidental original mains supply surge or lightning strike generally causing irreversible damage to the equipment.
- ▶ Replacement of fuses with fuses with different characteristics that could cause irreversible damage to the equipment.
- ▶ Obvious connection errors causing irreversible damage to the equipment.
- ▶ Water spray or running water inside the device that could result in irreversible electronic malfunctions.

Precautions for scrapping

This device contains electronic components and materials that must be recycled at the end of the product's usable life, for environmental reasons.

At the end of their usable lives all devices must therefore be returned either to the local distributor or entrusted to a specialist electronic equipment recycling company.

EC compliance

This device complies with the applicable European standards and has an EC mark. Its certificate of compliance is available on request.

For further information or assistance,
please contact:

REYA SAS

201 Avenue Irène et Frédéric Joliot Curie
ZI Toulon Est

83130 LA GARDE - FRANCE

Tél : (33) 0 493 904 700

Fax : (33) 0 493 474 257

e-mail : reya@reya.com

www.reya.com