



## INSTRUCTION MANUAL

VHF MARINE TRANSCEIVERS

# IC-M85 IC-M85E

This device complies with Part 15 of the FCC Rules. Operation is subject to the condition that this device does not cause harmful interference.

**Icom Inc.**



Thank you for choosing this Icom product. This product is designed and built with Icom's state of the art technology and craftsmanship. With proper care, this product should provide you with years of trouble-free operation.

---

## IMPORTANT

---

**READ ALL INSTRUCTIONS** carefully and completely before using the transceiver.

**SAVE THIS INSTRUCTION MANUAL** — This instruction manual contains important operating instructions for the IC-M85 and IC-M85E.

---

## EXPLICIT DEFINITIONS

---

WORD	DEFINITION
<b>⚠ DANGER!</b>	Personal death, serious injury or an explosion may occur.
<b>⚠ WARNING!</b>	Personal injury, fire hazard or electric shock may occur.
<b>CAUTION</b>	Equipment damage may occur.
<b>NOTE</b>	If disregarded, inconvenience only. No risk of personal injury, fire or electric shock.

---

## IN CASE OF EMERGENCY

---

If your vessel requires assistance, contact other vessels and the Coast Guard by sending a Distress call on Channel 16.

### USING CHANNEL 16

#### DISTRESS CALL PROCEDURE

1. "MAYDAY MAYDAY MAYDAY."
2. "THIS IS ....." (name of vessel).
3. Say your call sign or other description of the vessel (AND 9 digit DSC ID if you have one).
4. "LOCATED AT ....." (your position).
5. State the nature of the distress and assistance required.
6. Give any other information which might facilitate the rescue.

---

## RECOMMENDATION

---

**CLEAN THE TRANSCIVER THOROUGHLY IN A BOWL OF FRESH WATER** after exposure to saltwater, and dry it before operating. Otherwise, the transceiver's keys, switches, and controllers may become unusable, due to salt crystallization, and/or the charging terminals of the battery pack may corrode.

**NOTE:** If the transceiver's waterproof protection appears defective, carefully clean the transceiver with a soft, damp (fresh water) cloth, then dry it before operating. The transceiver may lose its waterproof protection if the case, jack cap, or connector cover is cracked or broken, or the transceiver has been dropped. Contact your Icom distributor or your dealer for advice.

---

# PRECAUTIONS

---

⚠ **DANGER! NEVER** short the terminals of the battery pack. Shorting may occur if the terminals touch metal objects such as a key, so be careful when placing the battery packs (or the transceiver) in bags, and so on. Carry them so that shorting cannot occur with metal objects. Shorting may damage not only the battery pack, but also the transceiver.

⚠ **DANGER! NEVER** use or charge Icom battery packs with non-Icom transceivers or non-Icom chargers. Only Icom battery packs are tested and approved for use with Icom transceivers or charged with Icom chargers. Using third-party or counterfeit battery packs or chargers may cause smoke, fire, or cause the battery to burst.

⚠ **DANGER! NEVER** operate the transceiver near unshielded electrical blasting caps or in an explosive atmosphere.

⚠ **WARNING! NEVER** hold the transceiver so that the antenna is very close to, or touching exposed parts of the body, especially the face or eyes, while transmitting. The transceiver will perform best if the microphone is 5 to 10 cm (2 to 4 inches) away from the lips and the transceiver is vertical.

⚠ **WARNING! NEVER** operate the transceiver with a headset or other audio accessories at high volume levels. The continuous high volume operation may cause a ringing in your ears. If you experience the ringing, reduce the volume level or discontinue use.

**CAUTION: DO NOT** use harsh solvents such as Benzine or alcohol when cleaning. This could damage the equipment surfaces. If the surface becomes dusty or dirty, wipe it clean with a soft, dry cloth.

**CAUTION: DO NOT** place or leave the transceiver in excessively dusty environments. This could damage the transceiver.

**CAUTION: DO NOT** expose the transceiver to rain, snow or any liquids. The transceiver meets IP67 requirements for dust-protection and splash resistance. However, once the transceiver has been dropped, dust protection and splash resistance cannot be guaranteed due to the fact that the transceiver may be cracked, or the waterproof seal damaged, and so on.

**DO NOT** place or leave the transceiver in direct sunlight or in areas outside of the specified temperature range:

IC-M85:                    -30°C (-22°F) ~ +60°C (+140°F)  
IC-M85E:                 -25°C ~ +55°C  
IC-M85E (Australian version): -10°C ~ +55°C

Keep the transceiver in a secure place to prevent use by unauthorized persons.

**BE CAREFUL!** Even if the volume level is set low, the beeps of the Man Down, Lone Worker and MOB functions are very loud.

Icom is not responsible for the destruction, damage to, or performance of any Icom or non-Icom equipment, if the malfunction is because of:

- Force majeure, including, but not limited to, fires, earthquakes, storms, floods, lightning, other natural disasters, disturbances, riots, war, or radioactive contamination.
- The use of Icom transceivers with any equipment that is not manufactured or approved by Icom.

Icom, Icom Inc. and Icom logo are registered trademarks of Icom Incorporated (Japan) in Japan, the United States, the United Kingdom, Germany, France, Spain, Russia, Australia, New Zealand, and/or other countries.

All other products or brands are registered trademarks or trademarks of their respective holders.

---

## PRÉCAUTIONS (pour le Canada)

---

⚠ **DANGER! NE JAMAIS** court-circuiter les bornes du bloc-batterie. Un court-circuit peut se produire si les bornes touchent des objets métalliques, tels que des clés, faites donc attention lorsque vous rangez des blocs-batteries (ou l'émetteur-récepteur) dans des sacs, etc. Transportez-les de telle sorte que des courts-circuits ne peuvent se produire avec des objets métalliques. Car cela peut endommager le bloc-batterie ainsi que l'émetteur-récepteur.

⚠ **DANGER!** N'utilisez JAMAIS et ne rechargez JAMAIS des blocs-batteries Icom avec des émetteurs-récepteurs non-Icom ou des chargeurs non-Icom. Seuls les blocs-batteries Icom sont testés et homologués pour être utilisés avec des émetteurs-récepteurs Icom ou pour être rechargés avec des chargeurs Icom. L'utilisation de blocs-batteries ou de chargeurs tiers ou de contrefaçon peut être à l'origine de fumées, d'incendie ou peut faire éclater la batterie.

⚠ **DANGER! NE JAMAIS** utiliser l'émetteur-récepteur à proximité de détonateurs électriques non blindés ou dans une atmosphère explosive.

⚠ **AVERTISSEMENT! NE JAMAIS** tenir le terminal de communication avec l'antenne placée à proximité immédiate ou en contact avec des parties du corps exposées, en particulier le visage ou les yeux, lors des transmissions. Les performances de la radio sont optimales quand le microphone est tenu entre 5 et 10 cm de la bouche de l'utilisateur et quand l'appareil est vertical.

⚠ **AVERTISSEMENT! NE JAMAIS** utiliser l'émetteur-récepteur avec un casque ou tout autre accessoire audio à un niveau sonore élevé. L'utilisation continue à un niveau sonore élevé peut provoquer un bourdonnement dans vos oreilles.

**ATTENTION: NE PAS** utiliser de dissolvants agressifs tels que du Benzène ou de l'alcool lors du nettoyage, car ils endommageraient les surfaces de l'émetteur-récepteur. Si l'émetteur-récepteur est poussiéreux ou sale, nettoyez-le avec un tissu doux et sec.

**ATTENTION: NE PAS** placer l'émetteur-récepteur dans des environnements excessivement poussiéreux. Cela pourrait endommager l'émetteur-récepteur.

**ATTENTION: NE PAS** exposer l'émetteur-récepteur à la pluie, à la neige ou à tout liquide. Cet émetteur-récepteur répond aux exigences de la norme IP67 en matière de protection contre la poussière et de résistance aux éclaboussures. Cependant, en cas de chute de l'émetteur-récepteur, la protection contre la poussière et la résistance aux éclaboussures ne peuvent plus être garanties, car le boîtier risque d'être fissuré ou le joint d'étanchéité endommagé, etc.

**NE PAS** placer ou laisser l'émetteur-récepteur en plein soleil ou dans un environnement soumis à des températures inférieures à  $-30^{\circ}\text{C}$  ( $-22^{\circ}\text{F}$ ) ou supérieures à  $+60^{\circ}\text{C}$  ( $+140^{\circ}\text{F}$ ).

Placez l'émetteur-récepteur dans un lieu sûr pour éviter toute utilisation par des personnes non autorisées.

**MISE EN GARDE!** Même si le niveau de volume est bas, les bips des fonctions Man Down, Lone Worker et MOB sont très forts.

Icom n'est pas responsable de la destruction ou des dommages sur l'émetteur-récepteur Icom, si le dysfonctionnement est causé par:

- Force majeure, sans toutefois s'y limiter, les incendies, tremblements de terre, tempêtes, inondations, la foudre, ou autres catastrophes naturelles, perturbations, émeutes, guerre, ou contamination radioactive.
- L'utilisation de l'émetteur-récepteur Icom avec tout équipement non fabriqué ou approuvé par Icom.

---

# TABLE OF CONTENTS

---

IMPORTANT.....	i
EXPLICIT DEFINITIONS.....	i
IN CASE OF EMERGENCY.....	i
RECOMMENDATION.....	i
PRECAUTIONS.....	ii
PRÉCAUTIONS (pour le Canada).....	iii
TABLE OF CONTENTS.....	vi
<b>1 OPERATING RULES.....</b>	<b>1</b>
<b>2 ACCESSORIES.....</b>	<b>2</b>
■ Supplied accessories.....	2
■ Attaching accessories.....	2
<b>3 PANEL DESCRIPTION.....</b>	<b>5</b>
■ Front, top and side panels.....	5
■ Function display.....	6
<b>4 BATTERY CHARGING.....</b>	<b>7</b>
■ Battery caution.....	7
■ Charging caution.....	8
■ Battery charger.....	9
<b>5 BASIC OPERATION.....</b>	<b>11</b>
■ Selecting a channel.....	11
■ Receiving and transmitting.....	13
■ Entering the ATIS code (For the German versions).....	13
■ Adjusting the squelch level.....	14
■ Using the VOX function.....	14
■ Using the AquaQuake water draining function.....	14
<b>6 SCAN.....</b>	<b>15</b>
■ Scan types.....	15
■ Favorite channels.....	16
■ Starting a scan.....	16

<b>7 DUALWATCH/TRI-WATCH.....</b>	<b>17</b>
■ Description.....	17
■ Operation.....	17
<b>8 OTHER FUNCTIONS.....</b>	<b>18</b>
■ Using the LAND channel group.....	18
■ Using the Voice Scrambler.....	18
■ Checking the battery health and battery cycle.....	18
<b>9 SET MODE.....</b>	<b>19</b>
■ Using the Set mode.....	19
■ Set mode items.....	20
<b>10 SPECIFICATIONS AND OPTIONS.....</b>	<b>23</b>
■ Specifications.....	23
■ Options.....	25
■ Using the HM-222.....	26
■ Using the BP-291.....	27
<b>11 VHF MARINE CHANNEL LIST.....</b>	<b>28</b>
<b>12 TROUBLESHOOTING.....</b>	<b>29</b>
<b>13 INFORMATION.....</b>	<b>30</b>
■ About CE and DOC.....	30
■ Disposal.....	30
■ Country code list.....	30
■ Firmware version identification.....	31
■ FCC information.....	31
■ Information FCC.....	31
■ Safety training information.....	32
■ Information en matière de sécurité.....	33
<b>INDEX.....</b>	<b>34</b>

## ◇ **Priorities**

- Read all rules and regulations pertaining to call priorities, and keep an up-to-date copy handy. Safety and distress calls take priority over all others.
- You must monitor Channel 16 when you are not operating on another channel.
- False or fraudulent distress calls are prohibited under law.

## ◇ **Privacy**

- Information overheard, but not intended for you, cannot lawfully be used in any way.
- Indecent or profane language is prohibited.

## ◇ **Radio licenses**

### **(1) SHIP STATION LICENSE**

You may require a current radio station license before using the transceiver. It is unlawful to operate a ship station which is not licensed, but required to be.

If required, contact your dealer or the appropriate government agency for a Ship-Radiotelephone license application. This government-issued license states the call sign which is your craft's identification for radio purposes.

### **(2) OPERATOR'S LICENSE**

A Restricted Radiotelephone Operator Permit is the license most often held by small vessel radio operators when a radio is not required for safety purposes.

If required, the Restricted Radiotelephone Operator Permit must be posted or kept with the operator. If required, only a licensed radio operator may operate a transceiver.

However, non-licensed individuals may talk over a transceiver if a licensed operator starts, supervises, ends the call and makes the necessary log entries.

A current copy of the applicable government rules and regulations is only required to be on hand for vessels in which a radio telephone is compulsory. However, even if you are not required to have these on hand it is your responsibility to be thoroughly acquainted with all pertinent rules and regulations.

## ■ Supplied accessories

Belt clip



Handstrap



Battery pack

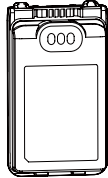

Antenna



Battery charger  
(With a screw)

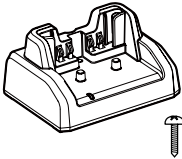

Power adapter  
(For Battery charger)

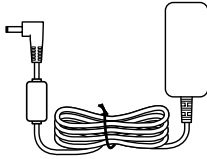

**NOTE:** Some accessories are not supplied, or the shape is different, depending on the transceiver version.

## ■ Attaching accessories

### ◇ Flexible antenna

Connect the supplied flexible antenna to the antenna connector.

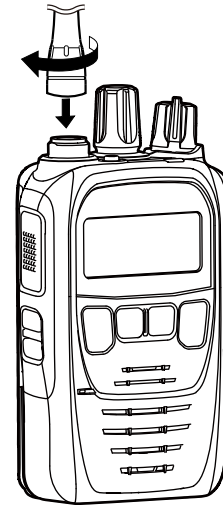

### CAUTION:

- **DO NOT** carry the transceiver by holding only the antenna.
- **DO NOT** connect an antenna other than those listed in this instruction manual.

## 2 ACCESSORIES

### ◇ Battery pack

**CAUTION: DO NOT** attach or detach the battery pack when the transceiver is wet or soiled. This may result in water or dust getting into the transceiver/ battery pack and may damage the transceiver.

#### To attach:

1. Slide the battery pack in the direction of the arrow. (1)
2. Push the battery pack until the battery sliding locks make a 'click' sound. (2)

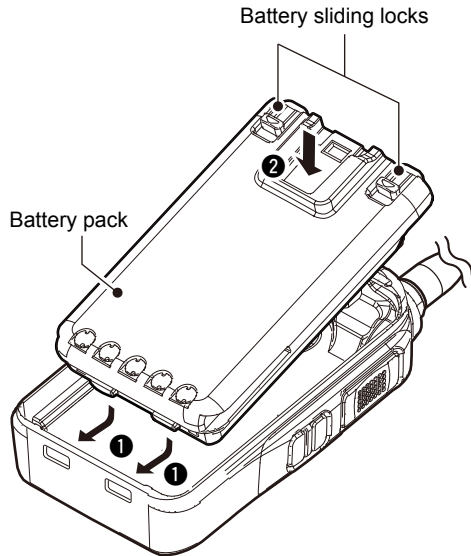

#### To detach:

1. Pull both battery sliding locks in the direction of the arrow. (1)
2. Lift up to detach the battery pack. (2)

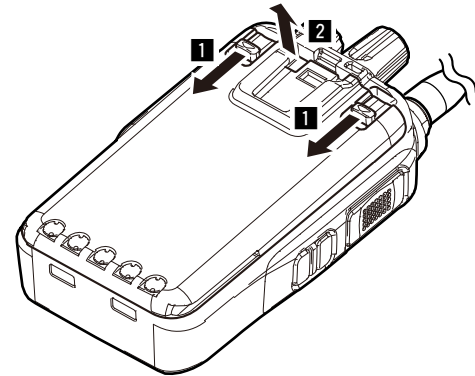

**NOTE:** Keep the battery pack terminals clean. It's a good idea to occasionally clean them.



## ◇ Belt clip

### To attach:

1. Remove the battery pack from the transceiver, if it is attached.
2. Slide the belt clip in the direction of the arrow until the belt clip is locked and makes a 'click' sound.

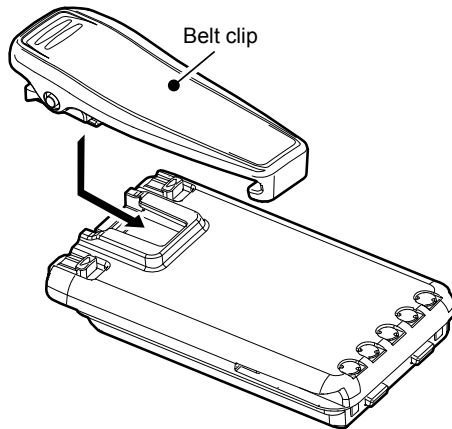

### To detach:

Lift the tab up (1), and slide the belt clip in the direction of the arrow (2).

**BE CAREFUL!** DO NOT break your fingernail.

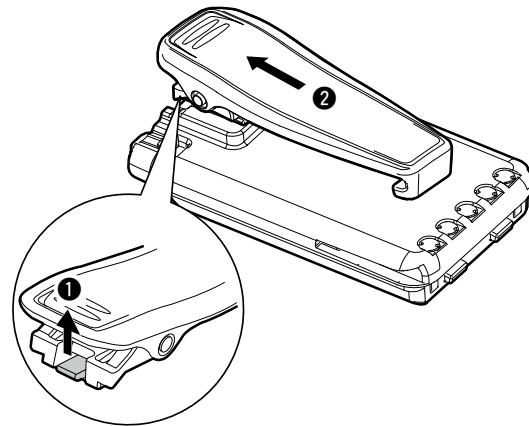

## ■ Front, top and side panels

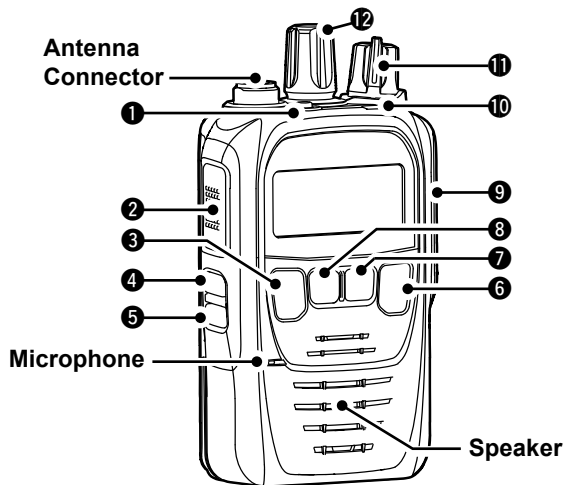

### ① LOCK KEY [↔]

Hold down for 1 second to lock or unlock the keypad.

① Push to use the pre-assigned function. Ask dealer for details.

### ② PTT SWITCH [PTT]

Hold down to transmit, release to receive.

### ③ CHANNEL 16/CALL CHANNEL KEY [16/C] (p. 11)

- Push to select Channel 16.
- Hold down for 1 second to select the Call channel.

### ④ SQUELCH ADJUSTMENT KEY [SQL] (p. 14)

- Push to enter or exit the Squelch Adjustment mode.
- Hold down to open the squelch, to monitor the channel.

### ⑤ TRANSMIT POWER KEY [H/L]

- Push to set the power level to high, mid, or low.
- ① Some channels are set to only low power.
- Hold down for 1 second to display the battery health and battery cycle. (p. 18)

### ⑥ FAVORITE CHANNEL KEY [FAV] (p. 16)

- Push to select a Favorite channel.
- Hold down for 1 second to set or clear the selected channel as a Favorite channel.

### ⑦ SCAN/DUALWATCH KEY [SCAN]/[DUAL]

- Push to start or stop a scan. (p. 15)
- Hold down for 1 second to start the Dualwatch.\* (p. 17)
- ① While Dualwatch, push to cancel Dualwatch.
- \*Tri-watch may start, depending on the Set mode settings.

### ⑧ WEATHER CHANNEL\*/ CHANNEL GROUP KEY [CH/WX]/[U/I/C/L]/[CH]

- Push to enter or exit the Weather Channel Selection mode.\* (p. 12)
- \*Except the European, UK, and German versions.
- Hold down for 1 second to change the channel group. (p. 12)

### ⑨ MULTI-CONNECTOR

Connects to an optional speaker microphone or headset.

### ⑩ STATUS INDICATOR

- Lights red while transmitting.
- Lights green while receiving a signal, or when the squelch is open.

### ⑪ VOLUME/POWER SWITCH [VOL]

- Rotate to turn the transceiver ON or OFF.
- Rotate to adjust the audio output level.

### ⑫ TUNING DIAL [DIAL]

- Rotate to select a channel.

## ■ Function display

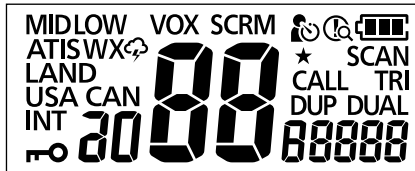

**TRANSMIT POWER INDICATOR** “MID”/“LOW”

Displayed when low power or mid power is selected.

**VOX INDICATOR** “VOX”

Displayed when the VOX function\* is ON.

\*Usable only when the optional PTT switch cable and headset are connected.

**VOICE SCRAMBLER INDICATOR** “SCRM”

Displayed when the Voice scrambler is ON. (p. 18)

**MAN DOWN ICON** “”





Displayed when the Man Down Alarm function is ON. (p. 22)

**LONE WORKER ICON** “”

Displayed when the Lone Worker Alarm function is ON. (p. 22)

**BATTERY INDICATOR** “”

Displays the battery status.

Battery status	Full	Mid	Charging required	Battery exhausted
Indication				

**FAVORITE CHANNEL ICON** “★”

Displayed when a Favorite channel is selected. (p. 16)

**SCAN INDICATOR** “SCAN”

Blinks while scanning. (p. 15)

**CALL CHANNEL INDICATOR** “CALL”

Displayed when the Call channel is selected. (p. 11)

**DUALWATCH/TRI-WATCH INDICATOR** “DUAL”/“TRI”

Displayed during Dualwatch or Tri-watch operation. (p. 17)

**DUPLEX INDICATOR** “DUP”

Displayed when a Duplex channel is selected.

**LOCK ICON** “”

Displayed when the Lock function is ON.

**CHANNEL GROUP INDICATOR** “INT”/“USA”/“CAN”/“LAND”/“ATIS”

Displays the selected channel group.\*1 (p. 12)

\*1 The selectable channel groups may differ, depending on the version.

**WEATHER CHANNEL ICON\*2** “WX”

Displayed when the Weather channel is selected. (p. 12)

① “” is displayed when the Weather Alert function is ON.

\*2 Except the European, UK, and German versions.

## ■ Battery caution

Misuse of Li-ion batteries may result in the following hazards: smoke, fire, or the battery may rupture. Misuse can also cause damage to the battery or degradation of battery performance.

⚠ **DANGER! NEVER** solder the battery terminals, or **NEVER** modify the battery pack. This may cause heat generation, and the battery may burst, emit smoke or catch fire.

⚠ **DANGER! NEVER** place or leave battery packs in areas with temperatures above 60°C (140°F). High temperature buildup in the battery cells, such as could occur near fires or stoves, inside a sun-heated vehicle, or in direct sunlight for long periods of time may cause the battery cells to rupture or catch fire. Excessive temperatures may also degrade the battery pack's performance or shorten the battery cell's life.

⚠ **DANGER! NEVER** strike or otherwise impact the battery pack. Do not use the battery pack if it has been severely impacted or dropped, or if the pack has been subjected to heavy pressure. Battery pack damage may not be visible on the outside of the case. Even if the surface of the battery does not show cracks or any other damage, the cells inside the battery may rupture or catch fire.

⚠ **DANGER! NEVER** expose the battery pack to rain, snow, seawater, or any other liquids. Do not charge or use a wet pack. If the pack gets wet, be sure to wipe it dry before using.

⚠ **DANGER! NEVER** place or leave battery packs near fire. Fire or heat may cause them to rupture or explode. Dispose of used battery packs in accordance with local regulations.

⚠ **DANGER! NEVER** let fluid from inside the battery get in your eyes. This can cause blindness. Rinse your eyes with clean water, without rubbing them, and immediately go to a doctor.

⚠ **WARNING! NEVER** put the battery pack in a microwave oven, high-pressure container, or in an induction heating cooker. This could cause a fire, overheating, or cause the battery cells to rupture.

⚠ **WARNING! NEVER** use the battery pack if it emits an abnormal odor, heats up, or is discolored or deformed. If any of these conditions occur, contact your Icom dealer or distributor.

⚠ **WARNING! NEVER** let fluid from inside the battery cells come in contact with your body. If it does, immediately wash with clean water.

**CAUTION: DO NOT** use the battery pack out of the specified temperature range for the transceiver (−30°C ~ +60°C (−22°F ~ +140°F)) and the battery itself (−20°C ~ +60°C (−4°F ~ +140°F)). Using the battery out of its specified temperature range will reduce its performance and battery cell's life. Please note that the specified temperature range of the battery may exceed that of the transceiver. In such cases, the transceiver may not work properly because it is out of its operating temperature range.

**CAUTION: DO NOT** leave the pack fully charged, completely discharged, or in an excessive temperature environment (above 50°C, 122°F) for an extended period of time. If the battery pack must be left unused for a long time, it must be detached from the transceiver after discharging. You may use the battery pack until the remaining capacity is about half, then keep it safely in a cool and dry place at the following temperature range:

–20°C ~ +50°C (–4°F ~ +122°F) (within a month)

–20°C ~ +40°C (–4°F ~ +104°F) (within three months)

–20°C ~ +20°C (–4°F ~ +68°F) (within a year)

**BE SURE** to replace the battery pack with a new one approximately five years after manufacturing, even if it still holds a charge. The material inside the battery cells will become weak after a period of time, even with little use. The estimated number of times you can charge the pack is between 300 and 500. Even when the pack appears to be fully charged, the operating time of the transceiver may become short when:

- Approximately 5 years have passed since the pack was manufactured.
- The pack has been repeatedly charged.

## ■ Charging caution

⚠ **DANGER! NEVER** charge the battery pack in areas with extremely high temperatures, such as near fires or stoves, inside a sun-heated vehicle, or in direct sunlight. In such environments, the safety/protection circuit in the battery will activate, causing the battery to stop charging.

⚠ **WARNING! NEVER** charge the transceiver during a lightning storm. It may result in an electric shock, cause a fire or damage the transceiver. Always disconnect the power adapter before a storm.

⚠ **WARNING! NEVER** charge or leave the battery in the battery charger beyond the specified time for charging. If the battery is not completely charged by the specified time, stop charging and remove the battery from the battery charger. Continuing to charge the battery beyond the specified time limit may cause a fire, overheating, or the battery may rupture.

⚠ **WARNING! NEVER** insert the transceiver (battery attached to the transceiver) into the charger if it is wet or soiled. This could corrode the battery charger terminals or damage the charger. The charger is not waterproof.

**CAUTION: DO NOT** charge the battery outside of the specified temperature range: BC-227 (15°C ~ 40°C (59°F ~ 104°F)). Otherwise, the charging time will be longer, but the battery will not reach a full charge. While charging, at a point after the temperature goes out of the specified range, the charging will automatically stop.

## 4 BATTERY CHARGING

### ■ Battery charger

#### ◇ Supplied battery charger

Charging time: approximately 2.7 hours

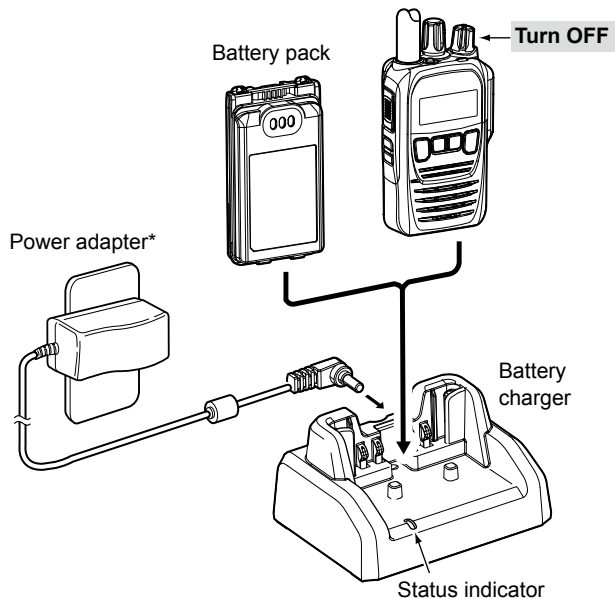

\* May not be supplied, or the shape may be different, depending on the transceiver version.

#### ◇ Optional BC-226 DESKTOP CHARGER

Charging time: approximately 2.7 hours

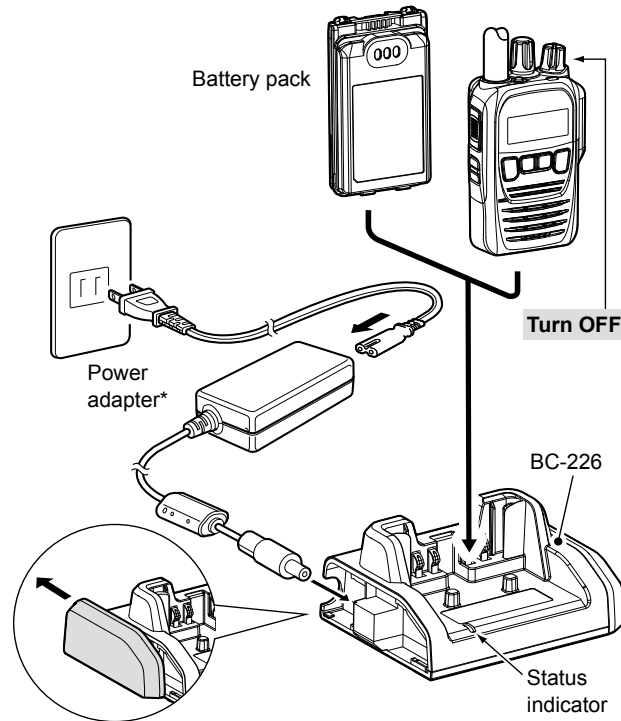

① To connect the power adapter to the charger, remove the charger's left cover.

○ **Connecting BC-226 together**

You can connect up to 6 BC-226 together.

1. Remove the charger's right cover. (1)
2. Snap the DC power plug to the other charger's DC power jack. (2)

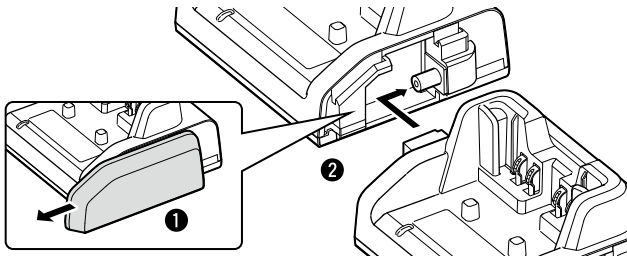

**WARNING: DO NOT** connect more than 6 chargers together. It may result in an electric shock, cause a fire, overheating, or damage chargers.

**NOTE:**

- The transceiver **MUST** be turned OFF while charging. Otherwise:
  - The battery will not be charged correctly.
  - The battery life may be shortened.
- Do not transmit while charging. When you need to transmit, remove the transceiver from the charger, and then turn ON the power.
- If the battery pack does not properly charge when it is attached to the transceiver, remove it from the transceiver and insert only the battery pack into the charger.

◇ **Information**

○ **Status indicator**

Light color	Status
Orange	Charging
Green	Charging is completed.
Blinks orange and green	Charging failed. It may have some problems.

○ **BC-226 Fuse replacement**

If a fuse blows, find and repair the cause of the problem. Then replace the damaged fuse with a new, adequately rated fuse.

Fuse type: 5 A/58 V (low profile mini blade fuse)

**NOTE:** Remove the fuse using the needle-nose pliers.

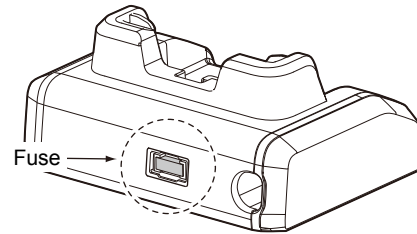

## ■ Selecting a channel

### ◇ Channel 16

Channel 16 is the distress and safety channel. It is used for establishing initial contact with a station, and for emergency communications.

While standing by, you must monitor Channel 16.

- Push [16/C] to select Channel 16.



### ◇ Call channel

Each Channel Group has separate Call channels. The Call channel is monitored during Tri-watch. The Call channels can be selected and used to store your most often used channel in each Channel Group, for quick recall.

- Hold down [16/C] for 1 second to select the Call channel.
- The Call channel number and "CALL" are displayed.



- ① To return to the previously selected channel, push [CH/WX]\*1 or [CH]\*2.

\*1 For the USA, Chinese, and Export versions.

\*2 For the European, UK, German, and Australian versions.

### ○ Setting the Call channel

By default, a Call channel is set in each Channel Group. You can set your most often-used channel as your Call channel in each Channel Group for a quick recall.

1. Hold down [16/C] for 1 second to select the Call channel.
  - "CALL" and Call channel number is displayed.
2. Hold down [16/C] again for 3 seconds (until a long beep changes to 2 short beeps).
  - The Call channel number blinks.

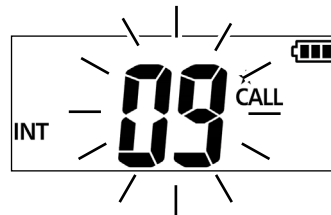

3. Rotate [DIAL] to select the channel.
4. Push [16/C] to set the selected channel as the Call channel.
  - The Call channel number stops blinking.



### ◇ Changing channel group

Channel Groups are preset into your transceiver. You can select the Channel Group between USA, International, Canadian, and ATIS depending on the transceiver version.

- Hold down [U/I/C/L]\*<sup>1</sup> or [CH]\*<sup>2</sup> for 1 second to change the channel group.

\*<sup>1</sup> For the USA, Chinese, and Export versions.

\*<sup>2</sup> For the European, UK, German, and Australian versions.

Version	Preset Channel Group			
	USA	INT	CAN	ATIS
USA	✓	✓	✓	
UK	✓	✓		
European		✓		
German		✓		✓
Australian	✓	✓		
Export (Other)	✓	✓	✓	
Chinese	✓	✓	✓	

### ◇ Weather channels

(Except the European, UK, and German versions.)

The transceiver has 10 preset Weather channels. You can use these channels to monitor broadcasts from the National Oceanographic and Atmospheric Administration (NOAA).

The transceiver automatically detects a Weather Alert tone on the selected Weather channel, or while scanning.

1. Push [CH/WX] or [CH]\*<sup>3</sup> to enter the Weather channel selection mode.

\*<sup>3</sup> For the Australian version.

2. Rotate [DIAL] to select a Weather channel.

#### ○ Setting the Weather Alert

1. Turn OFF the transceiver.
2. While holding down [SQL], Turn ON the transceiver to enter the Set mode.
3. Push [SQL] to select the Weather Alert item.
  - “ALrt” is displayed.
4. Rotate [DIAL] to turn ON the Weather Alert.
  - “☞” is displayed.
5. Push [16/C] to exit the Set mode.

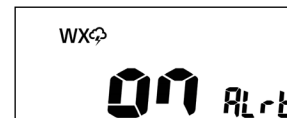

#### ○ Weather channel list

Channel	Frequency (MHz)	Channel	Frequency (MHz)
1	162.550	6	162.500
2	162.400	7	162.525
3	162.475	8	161.650
4	162.425	9	161.775
5	162.450	10	163.275

## 5 BASIC OPERATION

### ■ Receiving and transmitting

**CAUTION:** Transmitting without an antenna will damage the transceiver.

**NOTE:** Before using the transceiver for the first time, the battery pack must be fully charged for optimum life and operation. See Section 4 for battery charging.

1. Rotate [DIAL] to select a channel.
  - When a signal is received, the status indicator lights green.
2. Hold down [PTT], and speak into the microphone to transmit.
  - The status indicator lights red while transmitting.
3. Release [PTT] to receive.

**TIP:** To maximize the readability of your transmitted signal, pause for a second after pushing [PTT] and hold the microphone 5 to 10 cm (2 to 4 inches) from your mouth, and then speak at your normal voice level.

**NOTE:**

- To conserve battery power, the Power Save function automatically turns ON when no signal is received for 5 seconds.
- The Time-out Timer function cuts OFF transmission after 5 minutes\* of continuously transmitting, to prevent prolonged transmission.

\*10 seconds before transmission is cut off, a beep sounds to indicate the transmission will be cut off, and "TOT" blinks. After it is cut OFF, "TOT" is displayed for 10 seconds, and you cannot transmit until it disappears.

\*3 minutes for the Australian version.

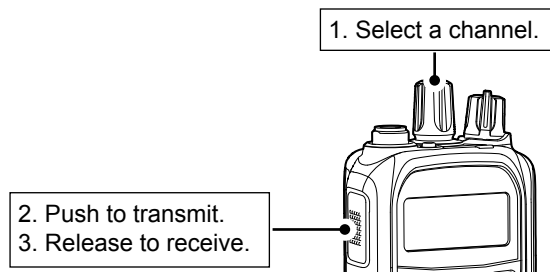

### ■ Entering the ATIS code (For the German versions)

The Automatic Transmitter Identification System (ATIS) ID consists of 10 digits. You can enter the ID as shown below.

**NOTE:** You can enter this initial code ONLY ONCE. After entry, only your dealer or distributor can change it. If your ATIS code has already been entered, this entry is not necessary.

1. Turn OFF the transceiver.
2. While holding down [16/C], turn ON the transceiver.
  - Enters the ATIS Code Entry mode, and the cursor blinks.
  - ① The ATIS code is displayed, if it has already been entered.
3. Enter a 10 digit ATIS code.
  - ① Rotate [DIAL] to select the number.
  - ① Push [SCAN] to move the cursor to the right.
  - ① Push [CH] to move the cursor to the left.
4. After entering the 10th digit, push [FAV] to set the ID.
5. Push [16/C] to exit the ATIS Code Entry mode.

## ■ Adjusting the squelch level

The squelch enables the audio to be heard only while receiving a signal that is stronger than the set level. A higher level blocks weak signals, so that you can receive only stronger signals. A lower level enables you to hear weak signals.

1. Push [SQL] to enter the Squelch Adjustment mode.

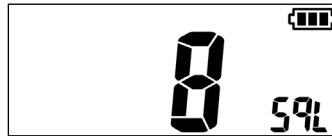

2. Rotate [DIAL] to adjust the squelch level, until the noise just disappears.
3. Push [16/C] to exit the Squelch Adjustment mode.

## ■ Using the VOX function

**NOTE:** The optional PTT switch cable and headset are required to use the function.

The VOX function automatically switches between receive and transmit by detecting your voice.

- While holding down [SQL], push [CH/WX]\*1 or [CH]\*2 to turn ON or OFF the function.
  - "VOX" is displayed.

\*1 For the USA, Chinese, and Export versions.

\*2 For the European, UK, German, and Australian versions.

## ■ Using the AquaQuake water draining function

Water in the speaker grill may muffle the sound coming from the speaker. The AquaQuake Water Draining function removes water from the speaker grill by vibrating the speaker cone.

- ① The AquaQuake Water Draining function is not usable when using an optional battery case or the optional speaker microphone.
1. While holding down [H/L], push [FAV] to turn ON the function.
    - "AQUA" is displayed.
    - A low frequency vibration beep sounds for 10 seconds to drain the water, regardless of the volume level setting.
  2. Push any key to turn OFF the function.

**TIP:** When the AquaQuake Action setting is ON in the Set mode, you can use the function by just shaking the transceiver within 30 seconds, after the water is detected (p. 22)

## ■ Scan types

You can find ongoing calls by scanning the Favorite channels.

### Before starting a scan, you need to:

- Set the channels that you want to scan as Favorite channels.
- ① Only the Favorite channels are scanned.
- Turn ON the Priority Scan in the Set mode to use the Priority Scan (p. 20).

### NORMAL SCAN

The Normal Scan sequentially searches through all Favorite channels. However, Channel 16 is not checked unless it is set as a Favorite channel.

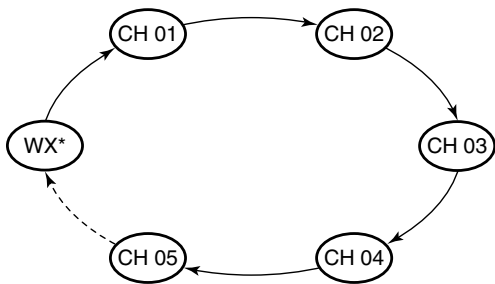

### PRIORITY SCAN

A Priority scan sequentially scans all Favorite channels while monitoring Channel 16.

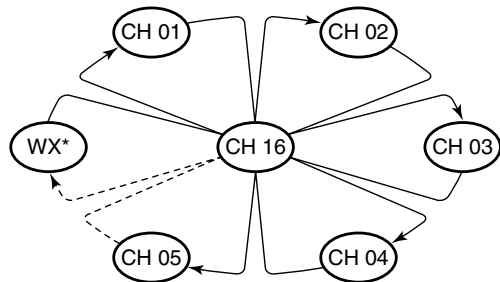

### When a signal is received:

- **On Channel 16**  
The scan pauses until the signal on Channel 16 disappears.
- **On a channel other than Channel 16:**  
The scan switches to Dualwatch, until the signal disappears.

\*Except the European, UK, and German versions, when the Weather Alert function is ON, the previously selected Weather channel is also scanned.

## Favorite channels

You can quickly recall often-used channels by setting them as Favorite channels.

### ◇ Setting/Clearing

1. Rotate [DIAL] to select a channel.
2. Push [FAV] to set or clear the channel as a Favorite channel.
  - “★” is displayed, when the channel is set as a Favorite channel.

### ◇ Selecting

- Push [FAV].
  - ① Non-Favorite channels are skipped and not displayed.

**TIP:** You can clear all Favorite channels.

- ① If there are no favorite channel, all channels will be set as favorite channels.
1. Turn OFF the transceiver.
2. While holding down [FAV], turn ON the transceiver.

## Starting a scan

1. Push [SCAN] to start a scan.
  - During a Normal scan, “SCAN” blinks.
  - During a Priority scan, “15” is also displayed.
  - ① When a signal is received, the scan pauses until the signal disappears, or resumes after pausing for 5 seconds, depending on the Set mode setting (p. 20).
  - ① Rotate [DIAL] to change the scanning direction.
2. Push [SCAN] again to cancel the scan.

**TIP:** In order to properly receive signals, be sure to adjust the squelch to a suitable level.

### Example: Starting a Normal Scan



Push [SCAN].

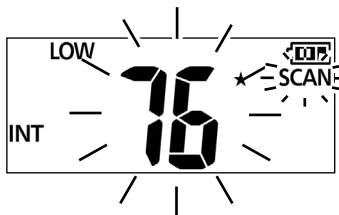

“SCAN” is displayed while scanning.

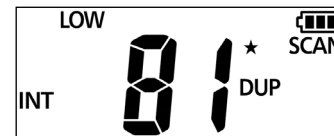

Status indicator lights green when a signal is received.

## ■ Description

Dualwatch and Tri-watch are convenient to monitor Channel 16 while you are operating on another channel.

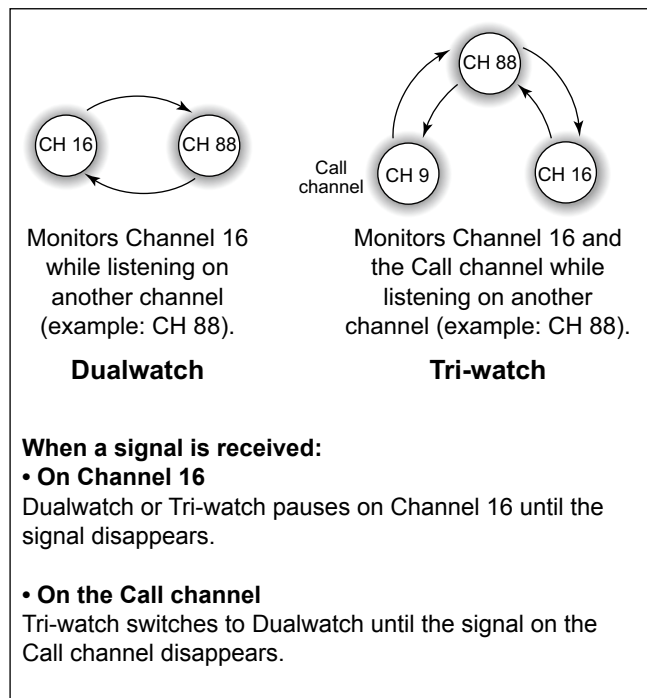

## ■ Operation

1. Select Dualwatch or Tri-watch in the Set mode (p. 20).
2. Select a channel.
3. Hold down [DUAL] for 1 second to start Dualwatch or Tri-watch.
  - During Dualwatch, "DUAL 16" blinks.
  - During Tri-watch, "TRI 16" blinks.
  - ① A beep tone sounds when a signal is received on Channel 16.
  - ① Tri-watch becomes Dualwatch while receiving a signal on the call channel.
4. Push [DUAL] again to cancel Dualwatch or Tri-watch.

Example: Operating Dualwatch on Channel 07.

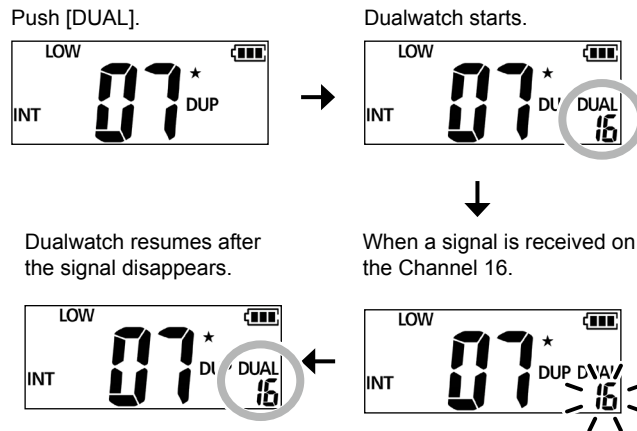

## ■ Using the LAND channel group

A maximum of 100 programmable channels (allocated 136.000 to 174.000 MHz) are preset into the LAND channel group for simple communication with LMR/PMR transceivers in the VHF band.

The default setting of the LAND channel group is the same as that of the INT channel group. Ask your local Icom dealer for the LAND channel group setting and LMR/PMR frequency setting details.

### ◇ Selecting the LAND channel group

- Hold down [U/I/C/L]\*<sup>1</sup> or [CH]\*<sup>2</sup> for 1 second to change the channel group.
  - “LAND” is displayed when the LAND channel group is selected.

\*<sup>1</sup> For the USA, Chinese, and Export versions.

\*<sup>2</sup> For the European, UK, German, and Australian versions.

## ■ Using the Voice Scrambler

The Voice Scrambler provides private communications. In order to receive or send scrambled transmissions, you must activate the scrambler function. You also need to set the scrambler code in the Set mode (p. 21).

① The Voice Scrambler is not usable on Channel 16.

- While holding down [SQL], push [SCAN/DUAL] to turn ON or OFF the function.
  - “SCRM” is displayed.

## ■ Checking the battery health and battery cycle

When you using the transceiver with the supplied battery pack, you can check the battery health and battery cycle.

- Hold down [H/L] for 1 second to the battery cycle.
  - Displayed for 5 seconds.
  - ① The battery health is indicated by the status indicator.



Light color	Battery health
Blue	80 ~ 100%
Purple	60 ~ 80%
Red	40 ~ 60%
Blinks red	0 ~ 40%

## ■ Using the Set mode

You can set seldom changed settings in the Set mode. You can customize the transceiver settings to suit your preference and operating style.

\*1 Except the European, UK, and German versions.

\*2 The “CH Display” item is displayed for each selectable channel group.

1. Turn OFF the transceiver.
2. While holding down [SQL], turn ON the transceiver to enter the Set mode.
  - The “Beep” item is displayed.
3. Push [SQL] or [H/L] to select an item.
4. Rotate [DIAL] to select an option.
5. Push [16/C] to exit the Set mode.

• Beep 	• WX Alert*1 <small>WX</small> 	• Scan Type 	• Scan Timer 	• Auto Scan 
• Dual/Tri-watch 	• SQL Key Action 	• Backlight 	• Contrast 	• Power save 
• CH Display*2 <small>USA</small> 	• Scrambler Code <small>SCRM</small> 	• VOX Level <small>VOX</small> 	• VOX Delay <small>VOX</small> 	• AquaQuake Action 
• Man Down Alarm <small>Ⓞ</small> 	• Lone Worker Alarm <small>Ⓢ</small> 	• Auto Volume Up 	• MOB Alarm 	



## ■ Set mode items

**NOTE:** The Set mode items contained in the transceiver may be different, depending on the transceiver's version or presets. Ask your dealer for details.

### ◇ Beep “ $\text{bEEP}$ ”

Turns the Key Beep function ON or OFF.

- OFF: Turns OFF the function for silent operation.
- ON: When a key is pushed, a beep sounds.

### ◇ WX Alert “ $\text{WXAL}$ ”

(Except the European, UK, and German versions.)

Turns the Weather Alert function ON or OFF.

This function detects the Weather Alert tone on Weather channels.

- OFF: The transceiver does not detect a Weather Alert tone.
- ON: The transceiver detects the 1050 Hz Weather Alert tone on a Weather channel.

### ◇ Scan Type “ $\text{Pr. S}$ ”

Turns the Priority Scan function ON or OFF.

- OFF: The scan type is set to “Normal,” which sequentially searches all Favorite channels in the channel group.
- ON: The scan type is set to “Priority,” which sequentially searches all Favorite channels in the channel group, while also periodically checking Channel 16 (Priority channel).

### ◇ Scan Timer “ $\text{S.T.}$ ”

Turns the Scan Resume Timer ON or OFF.

- OFF: When a signal is detected on a channel, the scan pauses until the signal disappears, and then resumes.
- ON: When a signal is detected on a channel, the scan pauses for 5 seconds, and then resumes. If the signal disappears in less than 5 seconds, the scan immediately resumes.

### ◇ Auto Scan “ $\text{AutS}$ ”

Turns the Automatic Scan function ON or OFF.

- OFF: The function is OFF.
- ON: Scan automatically starts when no signal is received, or no operations are carried out for 30 seconds.

### ◇ Dual/Tri-watch “ $\text{dt}$ ”

Selects the watch type.

- d- (Dual): The watch type is set to Dualwatch, which monitors Channel 16, even while receiving a signal on another channel.
- t- (Tri): The watch type is set to Tri-watch, which monitors Channel 16 and the Call channel, even while receiving a signal on another channel.

## 9 SET MODE

### ■ Set mode items (Continued)

#### ◇ SQL Key Action “SQLS”

The function temporarily opens the squelch.

- Pu (Push): The Monitor function is activated by holding down [SQL] for more than 1 second. The squelch opens while holding down the key.
- Ho (Hold): The Monitor function is activated by holding down [SQL] for more than 1 second. The squelch stays open until the user pushes any key.

#### ◇ Backlight “RLBL”

Turns the Automatic Backlight function ON or OFF.

- OFF: The function is OFF.
- ON: The backlight turns ON for 5 seconds when the user pushes any key except [PTT].

#### ◇ Contrast “LCDc”

Selects the transceiver's display contrast.

- Hi: The transceiver's display contrast is set to High.
- Lo: The transceiver's display contrast is set to Low.

#### ◇ Power Save “PSR”

Turns the Power Save function ON or OFF.

- OFF: The function is OFF.
- ON: The Power Save function reduces current drain by deactivating the receiver circuit of the transceiver at specific intervals.

#### ◇ CH Display “[H\_1]”/[H\_U]”/[H\_C]”/[H\_L]”

Selects the number of digits to display the channel number. You can select settings for each channel group.

- 3d: The channel number is displayed in 3 digits. (Example: 78A)
- 4d: The channel number is displayed in 4 digits. (Example: 1078)

#### ◇ Scrambler Code “CODE”

Set the voice scrambler code to between 1 and 32.

#### ◇ VOX Level “LE”

Sets the VOX gain level to between 1 (The lowest sensitivity) to 10 (The highest sensitivity). Higher values make the VOX function more sensitive to your voice.

#### ◇ VOX Delay “DEL R”

Sets the VOX Delay to between 1 (The shortest) to 6 (The longest) in 0.5 second steps.\*

\*Example: If the VOX delay is set to 2, transmitter stays ON for 1 second.

The VOX Delay is the amount of time the transmitter stays ON after you stop speaking before the VOX switches to receive.

### ◇ AquaQuake Action “**aq\_r**”

(Not displayed when using an optional battery case.)

Selects whether or not to activate the AquaQuake water draining function by shaking the transceiver.

① This function is not usable when using an optional battery case.

- OFF: While holding down [H/L], push [FAV] to turn ON the function.
- ON: You can use the function by just shaking the transceiver within 30 seconds, after the water is detected.

### ◇ Man Down Alarm “**md\_r**”

Sets the emergency mode detection angle to between 45, 60, or 75 degrees for the Man Down Alarm function.

If the transceiver leans past the set angle for the preset period of time, an alarm sounds.\*

① Push [PTT] to stop the alarm.

\*An alarm sounds from the transceiver's speaker, even if an optional speaker microphone is connected.

### ◇ Lone Worker Alarm “**lw\_r**”

Turns the Lone Worker Alarm ON or OFF.

If no operation occurs for the preset period of time, an alarm sounds.\*

① Push [PTT] to stop the alarm.

\*An alarm sounds from the transceiver's speaker, even if an optional speaker microphone is connected.

- OFF: The function is OFF.
- ON: If no operation occurs during a specified period of time, the transceiver automatically enter the Emergency mode.

### ◇ Auto Volume Up “**av\_r**”

Turns the Auto Volume Up function ON or OFF.

- OFF: The function is OFF.
- ON: The volume level is automatically increased when a signal is received in a noisy environment while the ship is pitching or rolling.

### ◇ MOB Alarm “**mb\_r**”

(Not displayed when using an optional battery case.)

Turns the MOB Alarm function ON or OFF.

This function is used when you fallen into the water and needs to be rescued.

① This function is not usable when using an optional battery case.

\*An alarm sounds from the transceiver's speaker, even if an optional speaker microphone is connected.

- OFF: The function is OFF.
- ON: An alarm sounds while the transceiver is in the water.

# 10 SPECIFICATIONS AND OPTIONS

## ■ Specifications

All stated specifications are subject to change without notice or obligation.

### IC-M85 (USA, Export):

#### ◇ General

- Frequency coverage:

Marine	TX	156.025 ~ 157.425 MHz
	RX	156.050 ~ 163.275 MHz
LMR		136.000 ~ 174.000 MHz
- Mode:

Marine	16K0G3E
LMR	16K0F3E (Wide)/11K0F3E (Narrow)
- Channel spacing:

Marine	±25 kHz
LMR	±25 kHz (Wide), ±12.5 kHz (Narrow)
- Current drain (at 7.2 V DC): TX High (5 W) 1.5 A typical  
Maximum audio 450 mA typical
- Frequency stability: ±5.0 ppm
- Operating temperature range:

Marine	-20°C ~ +60°C, -4°F ~ +140°F
LMR	-30°C ~ +60°C, -22°F ~ +140°F
- Dimensions (projections not included):

56 (W) × 92 (H) × 29 (D) mm,
2.2 (W) × 3.6 (H) × 1.1 (D) inches
- Weight (approximately): 215 g, 7.6 oz with BP-290
- Antenna impedance: 50 Ω nominal

#### ◇ Transmitter

- Output power:

Marine	5 W (Hi), 3 W (Mid), and 1 W (Low)
LMR (USA)	2 W (Hi), 1 W (Low)
LMR (Export/Chinese)	5 W (Hi), 3 W (Mid), and 1 W (Low)
- Modulation system: Variable reactance frequency modulation
- Maximum frequency deviation:

Marine	±5 kHz
LMR	±5 kHz (Wide), ±2.5 kHz (Narrow)
- Audio harmonic distortion: Less than 10% (at 60% deviation)
- Spurious emissions: Less than -70 dBc typical

#### ◇ Receiver

- Receive system: Double conversion superheterodyne
- Sensitivity (at 12 dB SINAD): 0.25 μV (typical)
- Squelch sensitivity (Threshold): 0.35 μV (typical)
- Intermodulation rejection ratio: 70 dB (typical)
- Spurious response rejection ratio: 70 dB (typical)
- Adjacent channel selectivity: 70 dB (typical)  
55 dB (typical) (Narrow, LMR only)
- Ham and Noise ratio: 40 dB  
34 dB (Narrow, LMR only)
- Audio output power: 0.7 W typical at 10% distortion into a 12 Ω load

**IC-M85E (European, UK, German, Australian):**

◇ **General**

- Frequency coverage:
 

Marine	TX	156.000 ~ 161.450 MHz
	RX	156.000 ~ 163.425 MHz
	TX (Australian)	156.025 ~ 157.425 MHz
	RX (Australian)	156.300 ~ 162.025 MHz
PMR		136.000 ~ 174.000 MHz
- Mode:
 

Marine	16K0G3E
PMR	16K0F3E (Wide)/8K50F3E (Narrow)
PMR (German)	14K0F3E (Wide)/8K50F3E (Narrow)
- Channel spacing:
 

Marine	±25 kHz
PMR	±25 kHz (Wide), ±12.5 kHz (Narrow)
PMR (German)	±20 kHz (Wide), ±12.5 kHz (Narrow)
- Current drain (at 7.2 V DC): TX High (5 W) 1.5 A typical  
Maximum audio 450 mA typical
- Frequency stability:
 

European/UK/German	±1.5 kHz
Australian	±5.0 ppm (Marine), ±1.5 kHz (PMR)
- Operating temperature range:
 

Marine	-15°C ~ +55°C
PMR	-25°C ~ +55°C
Marine (Australian)	-10°C ~ +55°C
PMR (Australian)	-10°C ~ +50°C
- Dimensions (projections not included):  
56 (W) × 92 (H) × 29 (D) mm
- Weight (approximately): 215 g with BP-290
- Antenna impedance: 50 Ω nominal

◇ **Transmitter**

- Output power: 5 W (Hi), 3 W (Mid), and 1 W (Low)
- Modulation system: Variable reactance frequency modulation
- Maximum frequency deviation:
 

Marine	±5 kHz
PMR	±5 kHz (Wide), ±2.5 kHz (Narrow)
PMR (German)	±4 kHz (Wide), ±2.5 kHz (Narrow)
- Audio harmonic distortion: Less than 10% (at 60% deviation)
- Spurious emissions:
 

European/UK/German	0.25 μW (below 2 GHz)
	1 μW (above 2 GHz)
Australian	Less than -70 dBc typical

◇ **Receiver**

- Receive system: Double conversion superheterodyne
- Sensitivity (at 20 dB SINAD): -4 dBμ EMF (Wide, Typical)  
-2 dBμ EMF  
(Narrow, Typical, PMR only)
- Squelch sensitivity (Threshold): -6 dBμ EMF (typical)
- Intermodulation rejection ratio:
 

European/UK/German	68 dB (Marine), 65 dB (PMR)
Australian	65 dB
- Spurious response rejection ratio:
 

European/UK/German	70 dB
Australian	65 dB (Marine), 70 dB (PMR)
- Adjacent channel selectivity:
 

European/UK/German	70 dB, 60 dB (Narrow, PMR only)
Australian (Marine)	65 dB
Australian (PMR)	70 dB (Wide), 60 dB (Narrow)
- Ham and Noise ratio: 40 dB  
34 dB (Narrow, PMR only)
- Audio output power: 0.7 W typical at 10% distortion into a 12 Ω load (at 1 kHz)

# 10 SPECIFICATIONS AND OPTIONS

## Options

### ◇ Battery pack/Battery case

#### • **BP-290** Li-ion BATTERY PACK

Voltage: 7.2 V

Capacity: 1910 mAh (minimum), 2010 mAh (typical)

Battery life: Approximately 14 hours\*

\*When the Power Save function is ON and the operating periods are calculated under the following conditions:

TX : RX : standby = 5 : 5 : 90

#### • **BP-291** BATTERY CASE

Battery case for AA alkaline batteries.

### ◇ Chargers

#### • **BC-227** RAPID CHARGER

#### + **BC-123S** AC ADAPTER, **OPC-515L** DC POWER CABLE

To rapidly charge the battery pack.

Charging time: Approximately 2.7 hours with BP-290

① **OPC-515L** DC POWER CABLE must be purchased separately.

#### • **BC-226** DESKTOP CHARGER + **BC-228** AC ADAPTER

You can connect up to 6 BC-226 together.

Charging time: Approximately 2.7 hours with BP-290

A power adapter may be supplied, depending on the charger's version.

#### • **BC-214** MULTI-CHARGER

#### + **BC-157S** AC ADAPTER, **OPC-656** DC POWER CABLE

For rapidly charging of up to 6 battery packs simultaneously.

Charging time: Approximately 2.8 hours

A power adapter may be supplied, depending on the charger's version.

① The **AD-132N** CHARGER ADAPTER may be needed, depending on the charger's version.

① **OPC-656** DC POWER CABLE must be purchased separately.

### ◇ Others

#### • **FA-SC58V** ANTENNA

#### • **MB-136, MBB-3** BELT CLIP

#### • **MB-96F, MB-96FL, MB-96N** BELT HANGERS

#### • **CP-23L** CIGARETTE LIGHTER CABLE

Used when charging a battery pack through a 12 V cigarette lighter socket.

#### • **HM-222** SPEAKER MICROPHONE

With a [H/L] key and Earphone jack.

The HM-222 meets IP68 requirements for waterproof protection.

#### • **HM-236** SPEAKER MICROPHONE

#### • **HM-163MC** TIEPIN TYPE MICROPHONE

+ **EH-15B** EARPHONE, **SP-26** TUBE EARPHONE, **SP-28** EAR HOOK TYPE EARPHONE

#### • **SP-32** TUBE TYPE EARPHONE ADAPTER

For use with EH-15B.

#### • **SP-27** TUBE EARPHONE, **SP-29** EAR HOOK TYPE EARPHONE

+ **AD-135** EARPHONE ADAPTER

**AD-135:** Used To connect an earphone to the transceiver's multi-connector.

#### • **AD-118** ACC ADAPTER

To connect an accessory. See the AD-118 instruction sheet for details on recommended accessories.

#### • **LC-187, LC-188\*** CARRYING CASE

\*Remove the LC-188 from the transceiver before charging.

#### • **VS-5MC** PTT SWITCH CABLE

+ **HS-94, HS-95, HS-97** HEADSET

**VS-5MC:** Used to connect a headset to a transceiver.

**HS-94:** Ear-hook type

**HS-95:** Neck-arm type

**HS-97:** Throat microphone

Some options may not be available in some countries.

Ask your dealer for details.

## ■ Using the HM-222

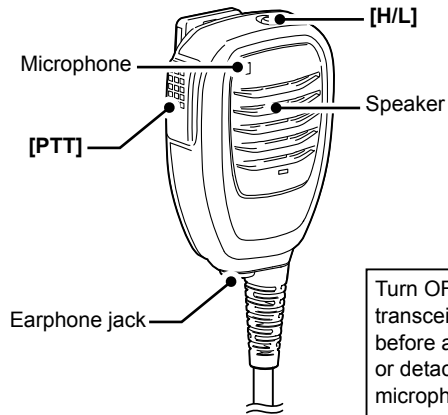

Turn OFF the transceiver before attaching or detaching the microphone

### NOTE:

- **NEVER** immerse the connector in water. If the connector becomes wet, **BE SURE** to dry it before attaching to the transceiver.
- The microphone element is located at the top left of the speaker microphone, as shown in the illustration above. To maximize the readability of your transmitted audio, hold the microphone approximately 5 to 10 cm (2 to 4 inches) from your mouth, and then speak at your normal voice level.

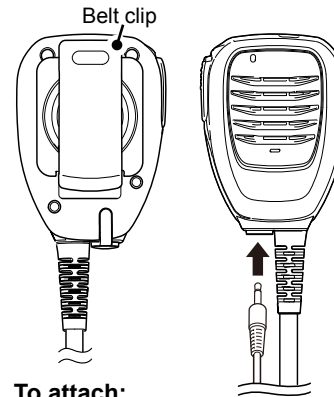

You can connect an earphone (user supplied) to the earphone jack on the microphone.

**To attach:**  
Attach the connector of the speaker microphone to the multi connector on the transceiver and tighten the screw.

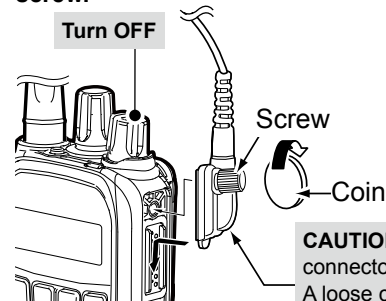

**CAUTION:** Firmly attach to the multi connector, but do not overtighten. A loose connection will allow water intrusion into the connector. Overtightening the connection can damage the transceiver.

## 10 SPECIFICATIONS AND OPTIONS

### ■ Using the BP-291

When using the optional BP-291 BATTERY CASE, install 5 × AA (LR6) size Alkaline batteries.

1. Open the battery case, and then remove the battery holder.

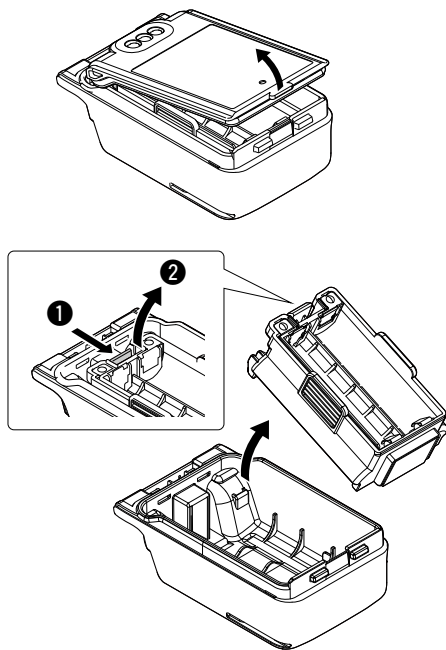

2. Install Alkaline batteries to the battery holder, and then insert it to the battery case.

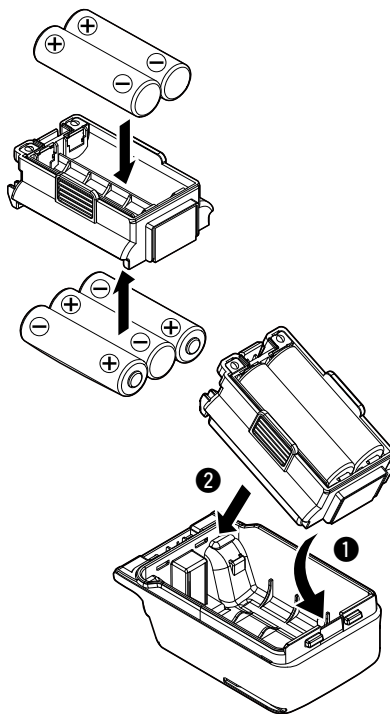

3. Firmly close the battery case.

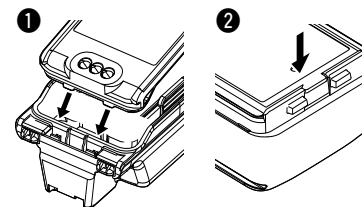

#### CAUTION:

- **NEVER** incinerate used battery cells since internal battery gas may cause them to rupture.
- **NEVER** expose a detached battery case to water. If the battery case gets wet, be sure to wipe it dry before using it.
- **NEVER** use batteries whose insulated cover is damaged.

#### NOTE:

- When installing the batteries, make sure they are all the same brand, type and capacity. Also, do not mix new and old batteries together.
- Keep the battery terminals clean. It's a good idea to occasionally clean them.



# VHF MARINE CHANNEL LIST

# 11

Channel number			Frequency (MHz)	
USA <sup>*9</sup>	INT	CAN <sup>*1</sup>	Transmit	Receive
	01	01	156.050	160.650
01A	01A <sup>*4</sup>		156.050	156.050
	02	02	156.100	160.700
	03	03	156.150	160.750
	04		156.200	160.800
		04A	156.200	156.200
	05		156.250	160.850
05A	05A <sup>*4</sup>	05A	156.250	156.250
06	06	06	156.300	156.300
	07		156.350	160.950
07A	07A <sup>*4</sup>	07A	156.350	156.350
08	08	08	156.400	156.400
09	09	09	156.450	156.450
10	10	10	156.500	156.500
11	11	11	156.550	156.550
12	12	12	156.600	156.600
13 <sup>*2</sup>	13	13 <sup>*2</sup>	156.650	156.650
14	14	14	156.700	156.700
15 <sup>*2</sup>	15 <sup>*7</sup>	15 <sup>*2</sup>	156.750	156.750
16	16	16	156.800	156.800
17 <sup>*2</sup>	17 <sup>*3</sup>	17 <sup>*2</sup>	156.850	156.850
	18		156.900	161.500
18A	18A <sup>*4</sup>	18A	156.900	156.900
	19		156.950	161.550
19A	19A	19A	156.950	156.950
	19b		Rx only	161.550
20	20	20 <sup>*2</sup>	157.000	161.600

Channel number			Frequency (MHz)	
USA <sup>*9</sup>	INT	CAN <sup>*1</sup>	Transmit	Receive
20A	20A		157.000	157.000
	20b		Rx only	161.600
	21		157.050	161.650
21A	21A <sup>*4</sup>	21A	157.050	157.050
		21b	Rx only	161.650
	22		157.100	161.700
22A	22A <sup>*4</sup>	22A	157.100	157.100
	23	23	157.150	161.750
23A	23A <sup>*4</sup>		157.150	157.150
		23b	Rx only	161.750
24	24 <sup>*5</sup>	24	157.200	161.800
25	25 <sup>*5</sup>	25	157.250	161.850
		25b	Rx only	161.850
26	26 <sup>*5</sup>	26	157.300	161.900
27	27	27	157.350	161.950
	27A <sup>*4</sup>		157.350	157.350
28	28	28	157.400	162.000
	28A <sup>*4</sup>		157.400	157.400
		28b	Rx only	162.000
37A <sup>*6</sup>	37A <sup>*6</sup>		157.850	157.850
	60	60	156.025	160.625
	61		156.075	160.675
		61A	156.075	156.075
	62		156.125	160.725
		62A	156.125	156.125
	63		156.175	160.775
63A	63A <sup>*4</sup>	63A	156.175	156.175

Channel number			Frequency (MHz)	
USA <sup>*9</sup>	INT	CAN <sup>*1</sup>	Transmit	Receive
	64	64	156.225	160.825
		64A	156.225	156.225
	65		156.275	160.875
65A	65A <sup>*4</sup>	65A <sup>*2</sup>	156.275	156.275
	66		156.325	160.925
66A	66A <sup>*4</sup>	66A <sup>*2</sup>	156.325	156.325
67 <sup>*2</sup>	67	67	156.375	156.375
68	68	68	156.425	156.425
69	69	69	156.475	156.475
71	71	71	156.575	156.575
72	72	72	156.625	156.625
73	73	73	156.675	156.675
74	74	74	156.725	156.725
	75 <sup>*2</sup>	75 <sup>*2</sup>	156.775	156.775
	76 <sup>*2</sup>	76 <sup>*2</sup>	156.825	156.825
77 <sup>*2</sup>	77	77 <sup>*2</sup>	156.875	156.875
	78		156.925	161.525
78A	78A	78A	156.925	156.925
	78b		Rx only	161.525
	79		156.975	161.575
79A	79A	79A	156.975	156.975
	79b		Rx only	161.575
	80		157.025	161.625
80A	80A <sup>*4</sup>	80A	157.025	157.025
	81		157.075	161.675
81A	81A <sup>*4</sup>	81A	157.075	157.075
	82		157.125	161.725

Channel number			Frequency (MHz)	
USA <sup>*9</sup>	INT	CAN <sup>*1</sup>	Transmit	Receive
82A	82A <sup>*4</sup>	82A	157.125	157.125
	83		157.175	161.775
83A	83A <sup>*4</sup>	83A	157.175	157.175
		83b	Rx only	161.775
84	84 <sup>*5</sup>	84	157.225	161.825
85	85 <sup>*5</sup>	85	157.275	161.875
86	86 <sup>*5</sup>	86	157.325	161.925
87	87	87	157.375	157.375
		87b <sup>*8</sup>	Rx only	161.975
88	88	88	157.425	157.425
	88b <sup>*8</sup>		Rx only	162.025
P4 <sup>*6</sup>	P4 <sup>*6</sup>		161.425	161.425

\*1 For only the USA and the Export version.

\*2 Low power only.

\*3 Low power only for the European, UK, and German version.

\*4 For only the USA and Export version.

\*5 For only the European, UK, German, and Australian version.

\*6 UK Marina Channels M1=37A (157.850 MHz), M2=P4 (161.425 MHz) for only the UK version.

\*7 Low power only except the Australian version.

\*8 For only the Australian version.

\*9 For only the USA, Export, and Australian version.

**NOTE:** When the "CH Display" is set to "4d" in the set mode, the channel number is displayed in 4 digits. See page 21 for details. (For example: Channel 78A is displayed as "1078," channel 78b" is displayed as "2078.")

10

11

# 12 TROUBLESHOOTING

PROBLEM	POSSIBLE CAUSE	SOLUTION	REF.
The transceiver does not turn ON.	<ul style="list-style-type: none"><li>• The battery is exhausted.</li><li>• The battery pack is not correctly attached.</li></ul>	<ul style="list-style-type: none"><li>• Recharge the battery pack.</li><li>• Correctly reattach the battery pack.</li></ul>	p. 9 p. 3
Little or no sound comes from the speaker.	<ul style="list-style-type: none"><li>• Squelch level is set too high.</li><li>• Volume level is set too low.</li><li>• The speaker has been exposed to water.</li></ul>	<ul style="list-style-type: none"><li>• Adjust the squelch level.</li><li>• Adjust the volume level.</li><li>• Use the AquaQuake Water Draining function to remove water from the speaker grill.</li></ul>	p. 14 p. 5 p. 14
You cannot transmit, or cannot select high power.	<ul style="list-style-type: none"><li>• Some channels are set for low power or receive only by regulations.</li><li>• The output power is set to low.</li></ul>	<ul style="list-style-type: none"><li>• Change channels.</li><li>• Push [H/L] to select high power.</li></ul>	p. 11 p. 5
Scan does not start.	<ul style="list-style-type: none"><li>• More than 2 favorite channels are not set.</li></ul>	<ul style="list-style-type: none"><li>• Set the Favorite channels.</li></ul>	p. 16
No beep sounds.	<ul style="list-style-type: none"><li>• The Key Beep function is OFF.</li></ul>	<ul style="list-style-type: none"><li>• Turn ON the Key Beep function.</li></ul>	p. 20
The keypad and [DIAL] does not work.	<ul style="list-style-type: none"><li>• The keypad and [DIAL] is locked.</li></ul>	<ul style="list-style-type: none"><li>• Hold down [↔] for 1 second to lock or unlock the keypad.</li></ul>	p. 5

## ■ About CE and DOC



Hereby, Icom Inc. declares that the versions of IC-M85E which have the “CE” symbol on the product, comply with the essential requirements of the Radio Equipment Directive, 2014/53/EU, and the

restriction of the use of certain hazardous substances in electrical and electronic equipment Directive, 2011/65/EU. The full text of the EU declaration of conformity is available at the following internet address:

<http://www.icom.co.jp/world/support/>

## ■ Disposal



The crossed-out wheeled-bin symbol on your product, literature, or packaging reminds you that in the European Union, all electrical and electronic products, batteries, and accumulators (rechargeable batteries) must be taken to

designated collection locations at the end of their working life. Do not dispose of these products as unsorted municipal waste. Dispose of them according to the laws in your area.

## ■ Country code list

• ISO 3166-1

	Country	Codes		Country	Codes
1	Austria	AT	18	Liechtenstein	LI
2	Belgium	BE	19	Lithuania	LT
3	Bulgaria	BG	20	Luxembourg	LU
4	Croatia	HR	21	Malta	MT
5	Czech Republic	CZ	22	Netherlands	NL
6	Cyprus	CY	23	Norway	NO
7	Denmark	DK	24	Poland	PL
8	Estonia	EE	25	Portugal	PT
9	Finland	FI	26	Romania	RO
10	France	FR	27	Slovakia	SK
11	Germany	DE	28	Slovenia	SI
12	Greece	GR	29	Spain	ES
13	Hungary	HU	30	Sweden	SE
14	Iceland	IS	31	Switzerland	CH
15	Ireland	IE	32	Turkey	TR
16	Italy	IT	33	United Kingdom	GB
17	Latvia	LV			

### ■ Firmware version identification

You can identify your transceiver's firmware version.

1. Turn OFF the transceiver.
2. While holding down [M], turn ON the transceiver.
  - The firmware version is displayed.
  - ① Example: "100 !" is displayed, when the firmware is Version 1.001.

### ■ FCC information

This equipment has been tested and found to comply with the limits for a Class A digital device, pursuant to part 15 of the FCC Rules. These limits are designed to provide reasonable protection against harmful interference when the equipment is operated in a commercial environment. This equipment generates, uses, and can radiate radio frequency energy and, if not installed and used in accordance with the instruction manual, may cause harmful interference to radio communications. Operation of this equipment in a residential area is likely to cause harmful interference in which case the user will be required to correct the interference at his own expense.

**CAUTION:** Changes or modifications to this transceiver, not expressly approved by Icom Inc., could void your authority to operate this transceiver under FCC regulations.

### ■ Information FCC

Cet équipement a été testé et reconnu conforme aux limites fixées pour un appareil numérique de classe A, conformément au point 15 de la réglementation FCC. Ces limites sont définies de façon à fournir une protection raisonnable contre le brouillage préjudiciable lorsque cet appareil est utilisé dans un environnement commercial. Cet équipement génère, utilise et peut émettre un rayonnement de fréquence radio. S'il n'a pas été installé conformément aux instructions, il peut par ailleurs créer des interférences perturbant les communications radio. L'utilisation de cet appareil dans une zone résidentielle peut provoquer un brouillage préjudiciable, auquel cas l'utilisateur sera tenu de corriger la situation à ses frais.

**MISE EN GARDE:** Tout changement ou modification, non expressément approuvé par Icom Inc., peut annuler l'autorisation de l'utilisateur à utiliser cet appareil conformément à la réglementation FCC.

## ■ Safety training information



Your Icom radio generates RF electromagnetic energy while transmitting. This radio is designed for and classified as for “Occupational Use Only.” This means it must be used only during the course of employment by individuals aware of the hazards, and the ways to minimize such hazards. This radio is NOT intended for use by the “General Population” in an uncontrolled environment. This radio has been tested and complies with the FCC and IC RF exposure limits for “Occupational Use Only”. In addition, your Icom radio complies with the following Standards and Guidelines with regard to RF energy and electromagnetic energy levels and evaluation of such levels for exposure to humans:

- FCC KDB Publication 447498 D03, Evaluating Compliance with FCC Guidelines for Human Exposure to Radio Frequency Electromagnetic Fields.
- American National Standards Institute (C95.1-1992), IEEE Standard for Safety Levels with Respect to Human Exposure to Radio Frequency Electromagnetic Fields, 3 kHz to 300 GHz.
- American National Standards Institute (C95.3-1992), IEEE Recommended Practice for the Measurement of Potentially Hazardous Electromagnetic Fields— RF and Microwave.
- The accessories listed on page i are authorized for use with this product. Use of accessories other than those specified may result in RF exposure levels exceeding the FCC requirements for wireless RF exposure.
- Health Canada Safety Code 6 - Limits of Human Exposure to Electromagnetic Energy in the Frequency Range from 3 kHz to 300 GHz.



To ensure that your exposure to RF electromagnetic energy is within the FCC allowable limits for occupational use, always adhere to the following guidelines:

- **DO NOT** operate the radio without a proper antenna attached, as this may damage the radio and may also cause you to exceed FCC RF exposure limits. A proper antenna is the antenna supplied with this radio by the manufacturer or an antenna specifically authorized by the manufacturer for use with this radio.
- **DO NOT** transmit for more than 50% of the total radio use time (“50% duty cycle”). Transmitting more than 50% of the time can cause FCC RF exposure compliance requirements to be exceeded. The radio is transmitting when “TX” is displayed on the function display. You can cause the radio to transmit by pushing the [PTT] switch.
- **ALWAYS keep** the antenna at least 2.5 cm (1 inch) away from the body when transmitting and only use the Icom belt-clips which are listed on page 12 when attaching the radio to your belt, or other place, to ensure FCC and IC RF exposure compliance requirements are not exceeded.

The information listed above provides the user with the information needed to make him or her aware of RF exposure, and what to do to assure that this radio operates within the FCC RF exposure limits of this radio.

### **Electromagnetic Interference/Compatibility**

During transmissions, your Icom radio generates RF energy that can possibly cause interference with other devices or systems. To avoid such interference, turn off the radio in areas where signs are posted to do so. **DO NOT** operate the transmitter in areas that are sensitive to electromagnetic radiation such as hospitals and blasting sites.

### **Occupational/Controlled Use**

The radio transmitter is used in situations in which persons are exposed as consequence of their employment provided those persons are fully aware of the potential for exposure and can exercise control over their exposure.

## ■ Infomation en matière de sécurité



Votre radio Icom produit une énergie électromagnétique de radiofréquences (RF), en mode de transmission. Cette radio est conçue pour un «usage professionnel seulement» et classée comme tel, ce qui signifie qu'elle doit être utilisée uniquement dans le cadre d'un travail par des personnes

conscientes des dangers et des mesures visant à minimiser ces dangers.

Elle N'EST PAS conçue pour une «utilisation grand public », dans un environnement non contrôlé. Cet appareil a été évalué et jugé conforme, aux limites d'exposition aux RF de la FCC et d'IC, pour une «utilisation grand public». En outre, votre radio Icom satisfait les normes et directives qui suivent en matière de niveaux d'énergie et d'énergie électromagnétique de RF et d'évaluation de tels niveaux en ce qui concerne l'exposition humaine:

- Publication 447498 D03 de la FCC KDB, «Evaluating Compliance with FCC Guidelines for Human Exposure to Radio Frequency Electromagnetic Fields».
- Norme de l'American National Standards Institute (ANSI): IEEE C95.1-1992 sur les niveaux de sécurité compatibles avec l'exposition humaine aux champs électromagnétiques de radiofréquences (3 kHz à 300 GHz).
- Norme de l'ANSI: IEEE C95.3-1992 sur la méthode d'évaluation recommandée du champ magnétique potentiellement dangereux des radiofréquences et des micro-ondes.
- Les accessoires illustrés dans "Options" de la feuille d'instructions sont approuvés pour une utilisation avec ce produit. L'utilisation d'accessoires autres que ceux précisés peut entraîner des niveaux d'exposition aux RF supérieures aux limites établies par la FCC et d'IC en matière d'exposition aux RF sans fil.
- Le Code de sécurité 6 de Santé Canada - Les limites d'exposition humaine à l'énergie électromagnétique dans la gamme de fréquences de 3 kHz à 300 GHz.



Afin de vous assurer que votre exposition à une énergie électromagnétique de RF se situe dans les limites permises par la FCC pour une utilisation grand public, veuillez en tout temps respecter les directives suivantes :

- **NE PAS** faire fonctionner la radio sans qu'une antenne appropriée y soit fixée, car ceci risque d'endommager la radio et causer une exposition supérieure aux limites établies par la FCC. L'antenne appropriée est celle qui est fournie avec cette radio par le fabricant ou une antenne spécialement autorisée par le fabricant pour être utilisée avec cette radio.
- **NE PAS** émettre pendant plus de 50% du temps total d'utilisation de l'appareil («50% du facteur d'utilisation»). Émettre pendant plus de 50% du temps total d'utilisation peut causer une exposition aux RF supérieure aux limites établies par la FCC. La radio est en train d'émettre lorsque le témoin du "TX" s'affiche sur l'écran ACL. La radio émettra si vous appuyez sur le bouton du microphone.
- **TOUJOURS** tenir l'antenne éloignée d'au moins 2,5 cm de votre corps au moment d'émettre et utiliser uniquement l'attache pour ceinture Icom illustrée à la p. 12, lorsque vous attachez la radio à votre ceinture, ou à autre chose, de façon à vous assurer de ne pas provoquer une exposition aux RF supérieure aux limites fixées par la FCC. Pour offrir à vos interlocuteurs la meilleure qualité de transmission possible, tenez l'antenne à au moins 5 cm de votre bouche et légèrement de côté.

Les renseignements ci-dessus fournissent à l'utilisateur toute l'information nécessaire sur l'exposition aux RF et sur ce qu'il faut faire pour assurer que cette radio fonctionne en respectant les limites d'exposition aux RF établies par la FCC.

### Interférence électromagnétique et compatibilité

En mode de transmission, votre radio Icom produit de l'énergie de RF qui peut provoquer des interférences avec d'autres appareils ou systèmes. Pour éviter de telles interférences, mettez la radio hors tension dans les secteurs où une signalisation l'exige. **NE PAS** faire fonctionner l'émetteur dans des secteurs sensibles au rayonnement électromagnétique tels que les hôpitaux, les aéronefs et les sites de dynamitage.

### Usage professionnel/contrôlé

Ce radio émetteur est utilisé dans des cas où des personnes sont exposées en raison de leur travail, pourvu qu'elles soient conscientes du risque d'exposition et qu'elles puissent exercer un contrôle sur cette exposition.

A		L		VOX Delay .....	21
Accessories		Lock key .....	5	VOX Level .....	21
Attaching .....	2			WX Alert .....	20
Supplied .....	2	O		Specifications .....	23
AquaQuake .....	14	Operating rules .....	1	Squelch .....	14
ATIS code .....	13	Options .....	25	T	
B		P		Transmitting .....	13
Backlight .....	21	Panel description .....	5	Troubleshooting .....	29
Basic operation .....	11	R		V	
Battery		Receiving .....	13	Voice scrambler .....	18
Battery cycle .....	18	S		VOX function .....	14
Battery health .....	18	Scan			
Caution .....	7	Normal scan .....	15		
Charger .....	9	Priority scan .....	15		
Charging caution .....	8	Set mode			
C		AquaQuake action .....	22		
Channel		Auto scan .....	20		
Selecting .....	11	Auto volume up .....	22		
Call channel .....	11	Beep .....	20		
Channel group .....	12	Channel display .....	21		
Channel list .....	28	Contrast .....	21		
Favorite channels .....	16	Dual/tri-watch .....	20		
Land channel .....	18	Lone worker alarm .....	22		
Weather channels .....	12	Man down alarm .....	22		
D		MOB alarm .....	22		
Dualwatch .....	17	Power save .....	21		
F		Scan timer .....	20		
Function display .....	6	Scan Type .....	20		
		Scrambler Code .....	21		
		SQL key action .....	21		

**Count on us!**

**< Intended Country of Use >**

- AT  BE  CY  CZ  DK  EE  
 FI  FR  DE  GR  HU  IE  
 IT  LV  LT  LU  MT  NL  
 PL  PT  SK  SI  ES  SE  
 GB  IS  LI  NO  CH  BG  
 RO  TR  HR