

Smart™ Sensors

Smarter & Well Connected

View depth, speed and temp on any instrument, chart plotter, or radar display that accepts NMEA data!

- Embedded signal processing eliminates the need for a depth sounder or knot meter.
- Accepts speed and temp inputs from analog sensors.
- Connect the Temp2 cable and measure engine room, live well, or any other temperature on the boat.
- Proven accurate depth readings from 0.4 m-100m at 235kHz and up to 200m at 170kHz.
- Stable bottom readings at speeds exceeding 40 knots.



TEMP2

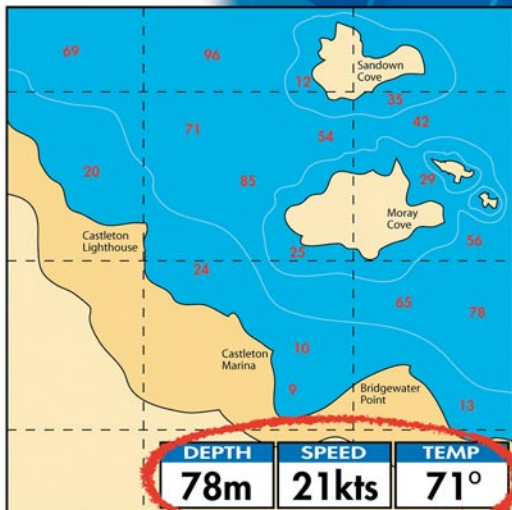

Through-hull model B122 with a streamlined fairing for a thick hull or steep deadrise



B17
Retractable

All Airmar Smart™ Sensors feature embedded signal processing. Cable lengths of up to 100 meters (330') are possible, with no loss of performance.

Airmar's Smart™ Sensors Get Even Smarter

What Makes a Sensor Smart?



SS557
Retractable

Airmar's Smart™ Sensors have embedded microelectronics—the transducer element and signal processor are only millimeters apart. The signal from our depth transducer is processed right inside the sensor and fed directly to any display with an NMEA port. In conventional navigation systems, a depth transducer sends its signal to a dedicated instrument which interprets the data for its display screen. Our Smart™ Sensors can make a chart plotter or radar screen do "double duty".

Who Benefits From Smart™ Technology?

Smart™ Sensors are right for both recreational and commercial navigation. Choose either 170kHz or 235kHz for the recreational market. At these frequencies, mutual interference with fishfinders is eliminated. For the commercial survey market, Airmar models operate at 200kHz.

Use Smart™ Sensors for low-cost, portable, survey systems and special applications like checking bridge abutments for scouring. Models designed to withstand high pressure can be used on remotely operated vehicles and automated underwater vehicles to measure distance above the sea floor. Our robust bottom tracking software will outperform other low priced systems.

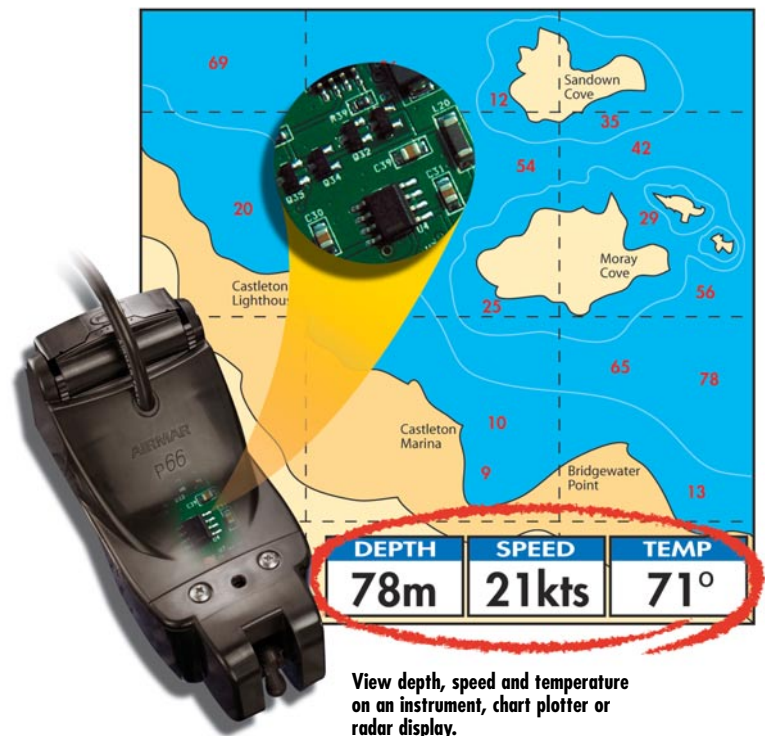

View depth, speed and temperature on an instrument, chart plotter or radar display.

What's New in 2002?

Now, our Smart™ depth transducers can accept input from Airmar's analog speed sensors. Speed signals are obtained in analog format and sent to the Smart™ Sensor where they are converted to digital data. With this approach, only one cable is routed to the display, simplifying installation. Airmar has added more functionality while eliminating the need for an NMEA combiner.

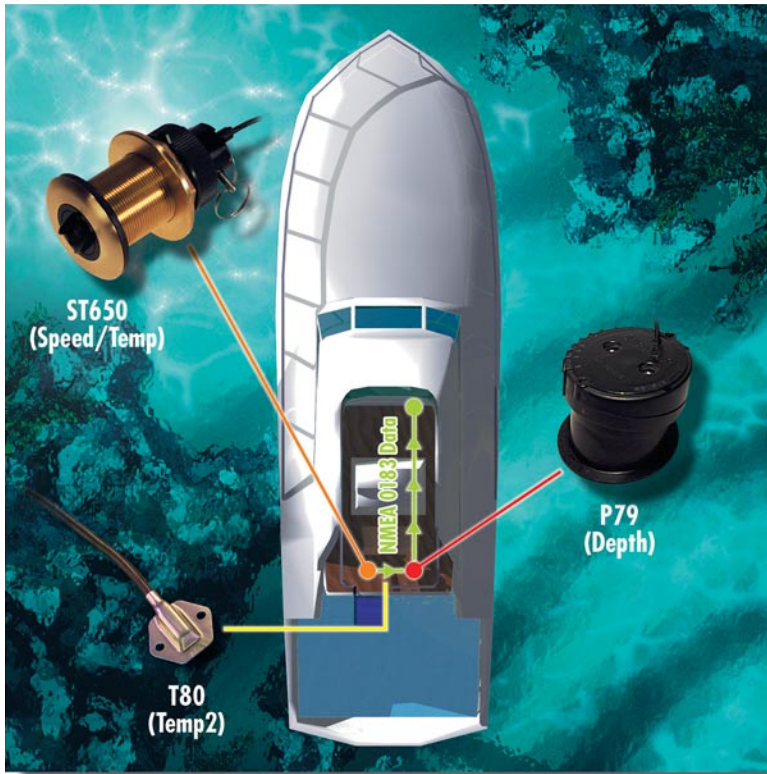

Want to check the temperature in the live well, the engine room, or on deck?

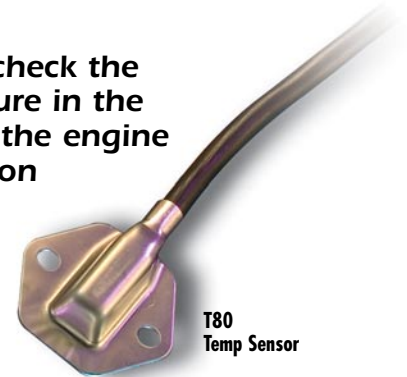

Temp2 makes it possible to measure a second temperature anywhere on the boat. Our Smart™ electronics can be programmed to the OEM's preference. With auto-configuration as a standard feature, a display screen only shows the functions that are selected by the OEM. For example, if there is no temperature option in the sensor, nothing will show on the display—an end user will never be confused by seeing 0°.



P17
Retractable

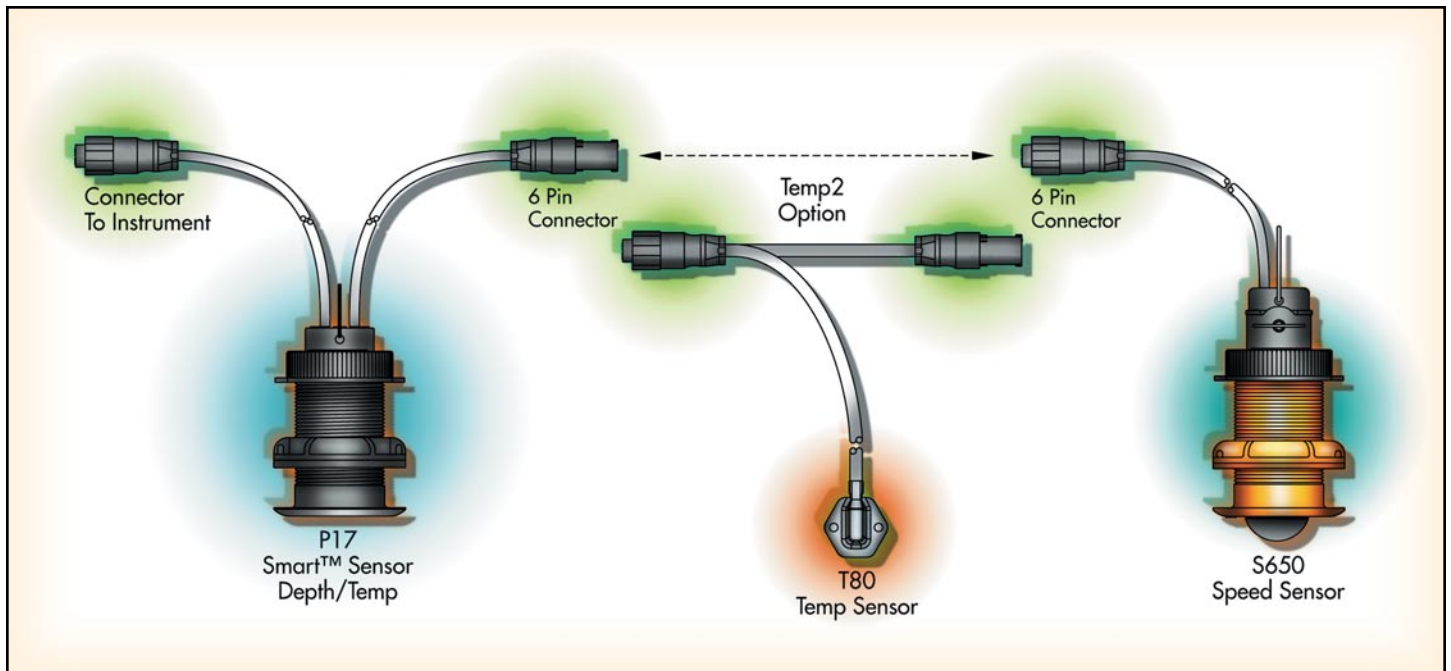

Specifications

Housings:



P79
Plastic In-Hull



P66
Plastic Transom Mount



P17 Retractable
Plastic Low Profile

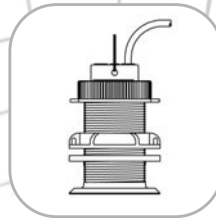

P314 Retractable
Plastic Flush Mount

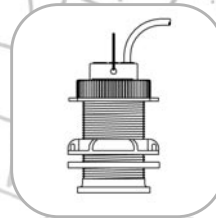

P217 Retractable
Plastic Flush Mount

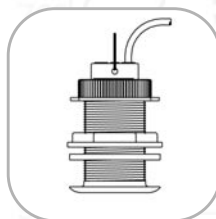

B17 Retractable
Bronze Low Profile



B21 Retractable
Bronze Flush Mount



B119 Retractable
Bronze Flush Mount

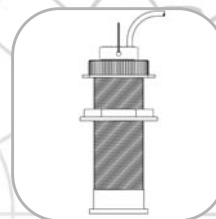

B122
Bronze Thru-Hull Mount

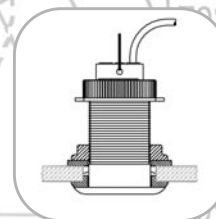

SS557 Retractable
Stainless Steel Low Profile

Options:

- Built-in water temperature measurement (except model P79)
- Built-in speed and water temperature (P66 only)
- Speed & temperature inputs accepted from analog sensor
- Temp2— second temperature measurement (except model P66)
- Custom communication protocol

Data output protocol:

NMEA 0183 sentence structure:

Depth: DDBT,DDPT
 Speed: VVHWH
 Distance: VVWLW
 Water Temperature: YXMTW
 Temp2: Proprietary "P" sentence supplied by customer

Technical Information:

Operating frequency	170 kHz	235 kHz
Transducer beam width @ -3db—all thru-hull models	13°	12°
Transducer beam width @ -3db—P66, P79	11°	7°
Data update rate	1/second	1/second
Minimum sounding depth	.04m	.04m
Maximum sounding depth	180m	100m
Pressure rating:	3m (10')	3m (10')
Complies with CE regulations	Yes, to IERC945	Yes, to IERC945
Supply voltage	8 VDC to 28 VDC	8 VDC to 28 VDC
Supply voltage @100% sound power output	11.5 VDC to 28 VDC	11.5 VDC to 28 VDC
Supply current	40 mA (depth, temp & paddlewheel speed), 190mA (depth, temp & ultrasonic speed)	
Reverse polarity protection	Yes	Yes
Over voltage protection	For transients only	For transients only
Standard connector	No connector	No connector
Standard cable type	C189, 22 AWG, 2 shielded pairs with standard NMEA colors	
Standard cable lengths	10m (33')	10m (33')
Maximum cable length	100m (330')	100m (330')