

FURUNO

OPERATOR'S MANUAL

INTEGRATED HEADING SENSOR

Model **PG-700**

IMPORTANT NOTICES

General

- This manual has been authored with simplified grammar, to meet the needs of the international users.
- The operator of this equipment must read and follow the descriptions in this manual. Wrong operation or maintenance can cancel the warranty or cause injury.
- Do not copy any part of this manual without written permission from FURUNO.
- If this manual is lost or worn, contact your dealer about replacement.
- The contents of this manual and equipment specifications can change without notice.
- The example screens (or illustrations) shown in this manual can be different from the screens you see on your display. The screens you see depend on your system configuration and equipment settings.
- Save this manual for future reference.
- Any modification of the equipment (including software) by persons not authorized by FURUNO will cancel the warranty.
- All brand and product names are trademarks, registered trademarks or service marks of their respective holders.

How to discard this product

Discard this product according to local regulations for the disposal of industrial waste. For disposal in the USA, see the homepage of the Electronics Industries Alliance (<http://www.eiae.org/>) for the correct method of disposal.

How to discard a used battery

Some FURUNO products have a battery(ies). To see if your product has a battery, see the chapter on Maintenance. Follow the instructions below if a battery is used. Tape the + and - terminals of battery before disposal to prevent fire, heat generation caused by short circuit.

In the European union

The crossed-out trash can symbol indicates that all types of batteries must not be discarded in standard trash, or at a trash site. Take the used batteries to a battery collection site according to your national legislation and the Batteries Directive 2006/66/EU.

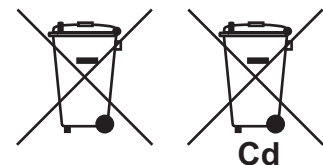

In the USA

The Mobius loop symbol (three chasing arrows) indicates that Ni-Cd and lead-acid rechargeable batteries must be recycled. Take the used batteries to a battery collection site according to local laws.

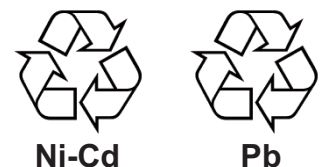



In the other countries

The Mobius loop symbol (three chasing arrows) indicates that Ni-Cd and lead-acid rechargeable batteries must be recycled. Take the used batteries to a battery collection site according to local laws.



SAFETY INSTRUCTIONS

Read these safety instructions before you operate the equipment.

 WARNING	Indicates a condition that can cause death or serious injury if not avoided.
 CAUTION	Indicates a condition that can cause minor or moderate injury if not avoided.

 Warning, Caution	 Prohibitive Action	 Mandatory Action
--	--	--

Instructions for the installer

 **WARNING**

 **Turn off the power at the mains switchboard before beginning the installation. Post a sign near the power switch indicating it should not be turned while the equipment is being installed.**

Fire, electrical shock or serious injury can result if the power is left on or is applied while the equipment is being installed.

 **Use specified cable to connect the Junction Box.**

Use of the wrong cable can result in bodily injury and cause fire.

 **CAUTION**

 **Be sure to connect to the correct power supply.**

Connection to a wrong power supply can cause fire or bodily injury.

 **Observe the following compass safe distances to prevent interference to a magnetic compass.**

Std. Compass	Steering compass
0.3 m	0.3 m

 **Before doing deviation correction and heading adjustment, turn off the autopilot.**

The rudder may jerk violently, which can result in a dangerous situation.

Instructions for the user

 **WARNING**

 **Turn off power at the switchboard if the equipment is emitting smoke or fire.**

Fire or electrical shock can result if the power remains on

 **Turn off the power at the switchboard if you feel the equipment is not working properly.**

If the equipment feels hot or is emitting odd noises, immediately turn off the power at the switchboard.

 **Do not disassemble or modify the equipment.**

Fire, electrical shock or bodily injury can result.

TABLE OF CONTENTS

- FOREWORD..... iv**
- SYSTEM CONFIGURATION v**
- EQUIPMENT LIST vi**

- 1. HOW TO INSTALL THE EQUIPMENT 1**
 - 1.1 Installation Considerations 1
 - 1.2 Wiring 6
 - 1.3 Compensation of Deviation 9
 - 1.4 Heading Adjustment 11
 - 1.5 Input/Output Data List..... 13

- 2. OPERATION 14**
 - 2.1 Key and Lamp Explanation..... 14
 - 2.2 How to Turn on the PG-700 15

- 3. MAINTENANCE AND TROUBLESHOOTING..... 16**
 - 3.1 General Maintenance 16
 - 3.2 Lamp status display 16
 - 3.3 Troubleshooting 18
 - 3.4 How to restore default settings 18

- Specifications SP-1**
- Outline Drawings..... D-1**
- Interconnection Diagram S-1**

FOREWORD

Congratulations on your choice of the PG-700 Integrated Heading Sensor. We are confident you will see why the FURUNO name has become synonymous with quality and reliability.

Since 1948, FURUNO Electric Company has enjoyed an enviable reputation for innovative and dependable marine electronics equipment. This dedication to excellence is furthered by our extensive global network of agents and dealers.

Your equipment is designed and constructed to meet the rigorous demands of the marine environment. However, no machine can perform its intended function unless properly operated and maintained. Please carefully read and follow the operation and maintenance procedures set forth in this manual.

Features

- Angular velocity sensor and magnetic bearing sensor incorporated.
- Automatic determination of installation site suitability.
- L-shaped mounting base for mounting on bulkhead.
- Output of magnetic bearing data to FURUNO CAN bus device.

SYSTEM CONFIGURATION

The solid line below shows the basic system configuration.

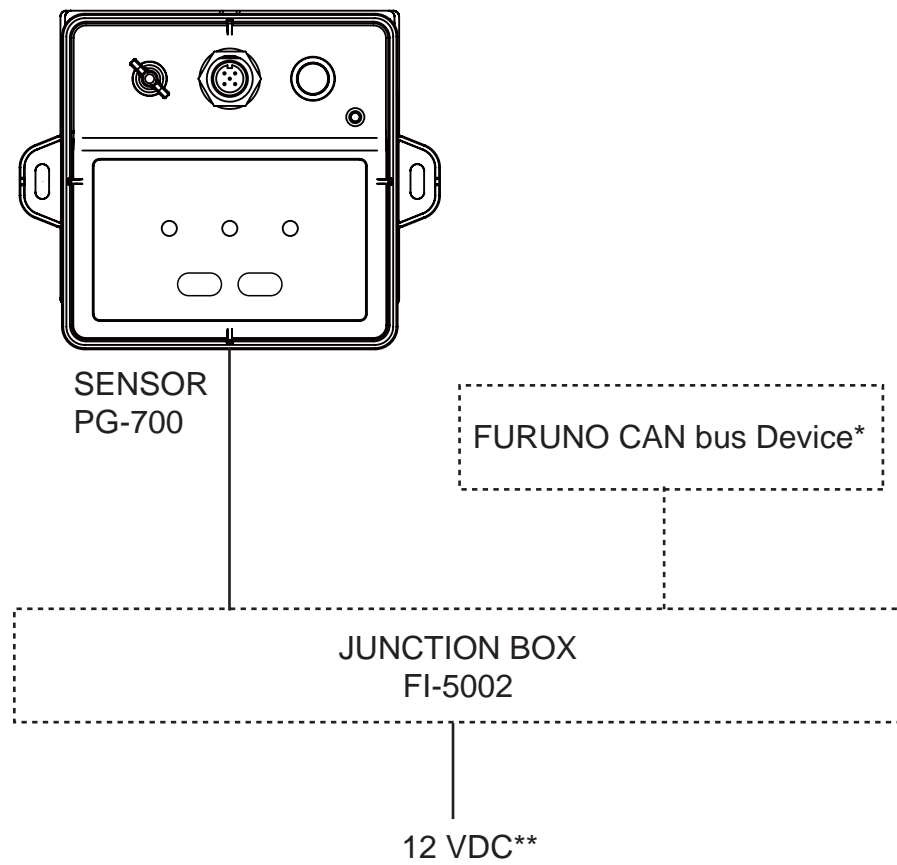

*: NavNet 3D, FI series instrument, etc.

** : Not necessary if FURUNO CAN bus network supplies power.

EQUIPMENT LIST

Standard Equipment

Name	Model	Code number	Quantity	Remark
Sensor	PG-700	-	1	
Installation materials	CP64-02800	-	1 set	<ul style="list-style-type: none">• Cable set Type: M12-05BM+05BF-060 Code number: 000-167-964-11 Quantity: 1• Self-tapping screws Type: 4x16 SUS304 Code number: 000-162-605-10 Quantity: 3

Optional Equipment

Name	Model	Code number	Quantity	Remark
Junction box	FI-5002	000-010-765	1 set	
Cable set	FI-50-DROP-6M	001-105-810-10	1	6m

1. HOW TO INSTALL THE EQUIPMENT

1.1 Installation Considerations

Mount the unit with the lamps and keys face up on a horizontal surface. The unit can be mounted on a desktop or bulkhead. Overhead mounting is not allowed. When selecting a mounting location, observe the following to ensure optimal performance:

- Do not mount in an area where water can collect.
- Mount the unit in an area with a temperate between -15 and +55 °C (5 -131°F).
- Mount the unit in an area with low shock and vibration (near the center of gravity to the hull as possible).
- Mount far away from any electromagnetic wave sources (radio antennas, etc.).
- Mount horizontally, and not on the ceiling.
- Mount as far away as possible from any magnetic interference and power cables.
- Mount at least 50cm (20") away from the following:
 - Engines, generators, steel fuel and water tanks
 - Bilge pump, anchor, anchor chain
 - Radio antenna cables
 - Metal mast support and keel
- Mount in a location where it is easy to adjust or perform maintenance.
- Mount close to the ship's draft (do not mount to the mast or Tuna tower).

1. HOW TO INSTALL THE EQUIPMENT

Determining the mounting location

After choosing the approximate mounting location to a table or bulkhead, ensure that the location is suitable to supply power to the unit.

1. Connect the power cable to the unit.

If the sensor unit is connected last to the optional Junction Box FI-5002, cut off the connector (supplied) of the cable M12-05BM+05BF-060 from the FI-5002 side, and connect the red wire of the cable to the positive terminal (+) of the battery (12 VDC) and the black wire to the negative terminal (-).

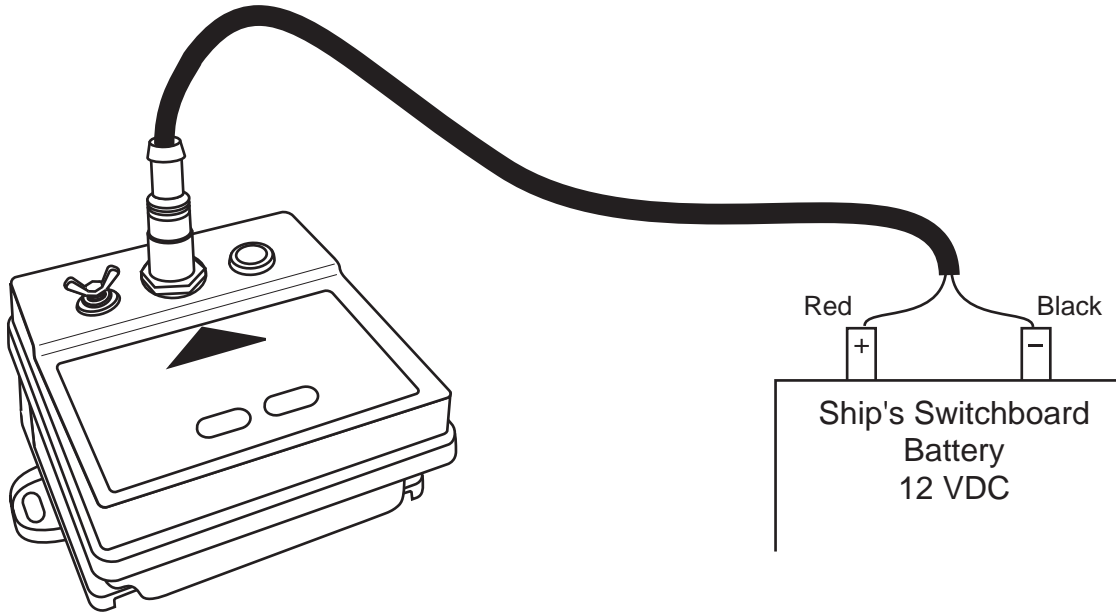

If you connect PG-700 directly to the instrument, or to a network, each device must be temporarily connected to each other, and a power supply 12 VDC (see page 6).

2. Place the unit at the intended mounting position and supply power. Verify that the STATUS lamp is not lit red.
If the STATUS lamp illuminates red, there may be a problem with the internal magnetic sensor.
3. Press and hold the [+] and [-] keys simultaneously for seven seconds, and release both keys. The CHECK lamp blinks, and the CALIB and STATUS lamps turn off.

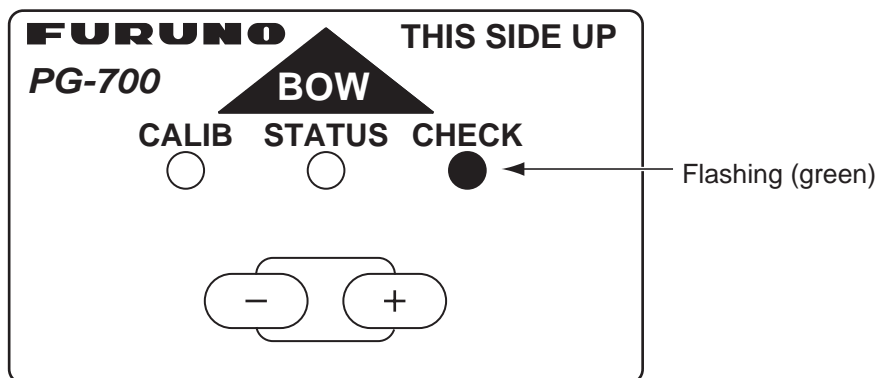

4. Slowly turn the unit (one turn per minute) at the mounting position (turn one - two times to achieve the results as shown in the left figure below).
If successful, the STATUS and CHECK lamps light green. If fails, the STATUS lamp lights red.

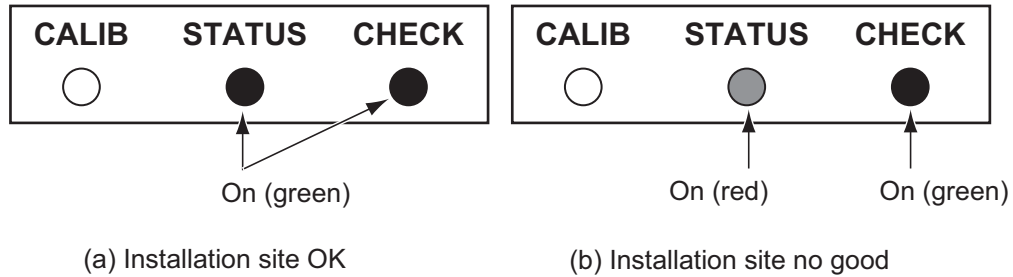

If you interrupt the unit operation, press and hold the [+] and [-] keys simultaneously for three seconds.

NOTICE
<p>This location check procedure requires only 90 seconds or less to complete.</p> <p>If STATUS and CHECK lamps light green, fix the unit to the acceptable location properly.</p>

5. If fails, press and hold the [+] and [-] keys simultaneously for 3 seconds. Change the location, and repeat steps 3 - 4 as above.
6. If successful, disconnect the power cable and follow the next steps to mount the unit firmly.

1. HOW TO INSTALL THE EQUIPMENT

Tabletop mounting

Fix the unit with two self-tapping screws, facing the bow mark on the unit toward the bow (within $\pm 10^\circ$) of the vessel. The long and round holes on the unit allow you to fine tune the direction of the unit. See the outline drawing at the back of the manual for dimensions.

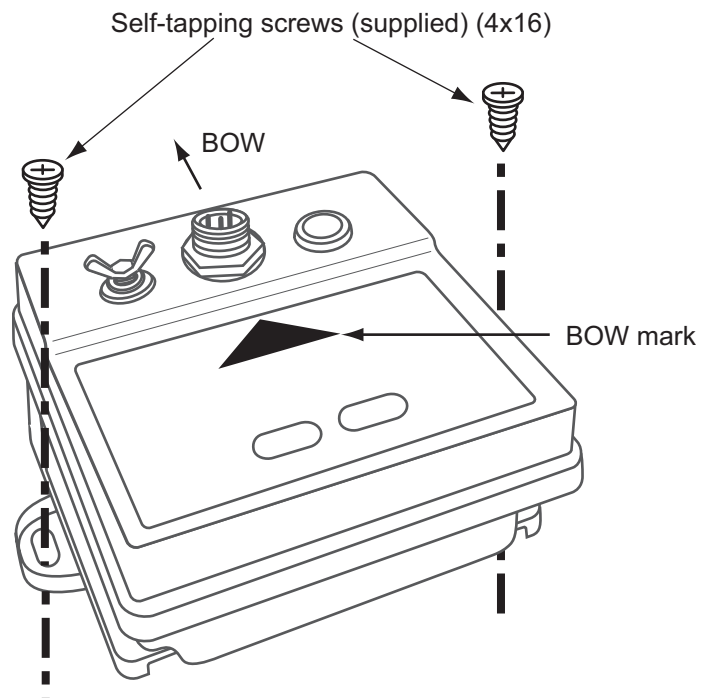

Bulkhead mounting

The unit can be mounted to the bulkhead either parallel or vertical to the bow.

1. Remove two screws at the bottom to detach the mounting base.
2. Remount the base upside down using the two screws which were unscrewed in the above step. It is possible to mount the unit in any horizontal direction in 90° steps. Mount the unit so that the bow mark faces in the direction of the ship's bow.

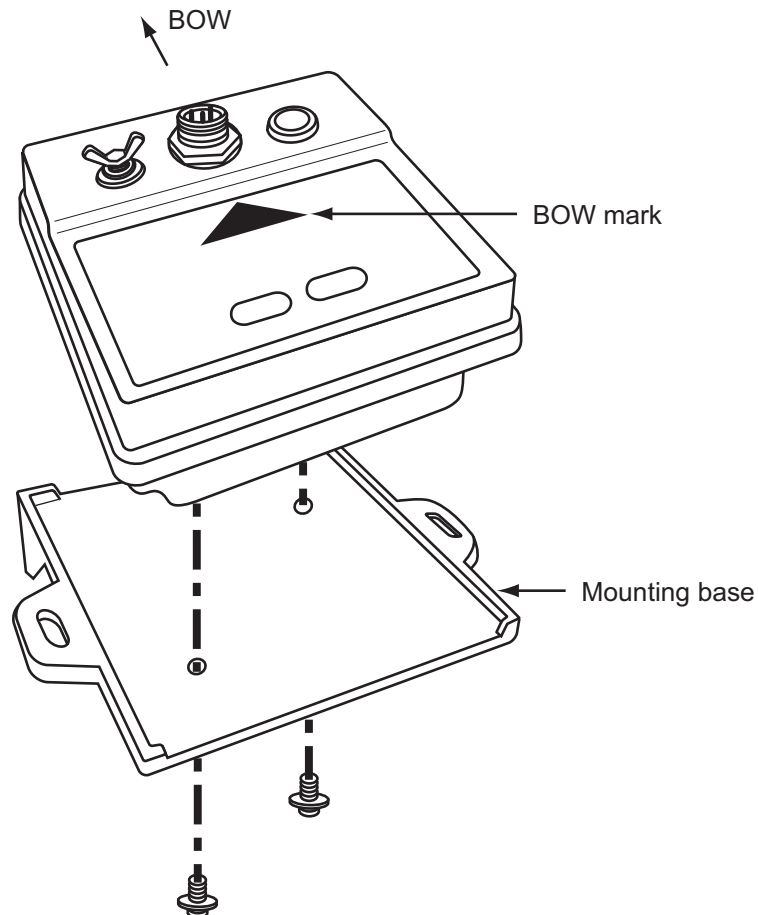

3. Fix the mounting base to the bulkhead with three self-tapping screws supplied.

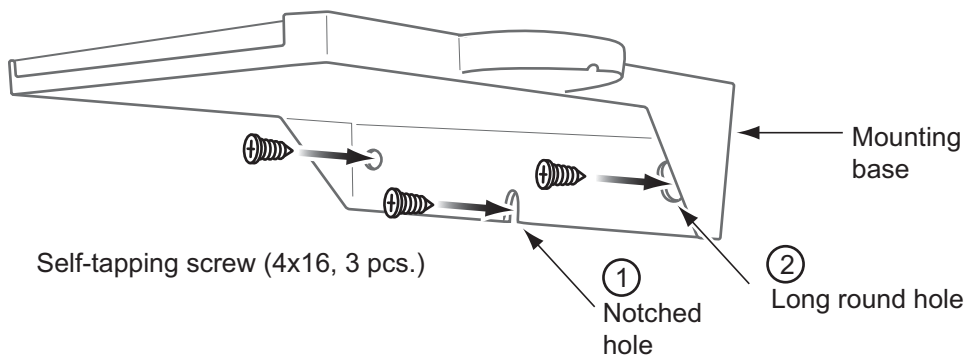

- 1) Insert one screw in the place for the notched hole, halfway.
- 2) Set the notched hole in the center of the mounting base to the screw inserted into the bulkhead at step 1. Set a self-tapping screw in the long round hole. Adjust the mounting base so it is horizontal and then tighten the self-tapping screws in the long round hole, and the notched hole, in that order.
- 3) Fasten the remaining left self-tapping screw.

1. HOW TO INSTALL THE EQUIPMENT

1.2 Wiring

Connect a termination resistor at both ends of the backbone of CAN bus devices. PG-700 incorporates a termination resistor. Turn the switch on/off as applicable.

If using the optional Junction Box FI-5002

Connect the unit and the FI-5002 using cable M12-05BM+05BF-060 (supplied as installation materials). For connection at the FI-5002, cut the cable at the pre-connected connector, fabricate the cable as shown below, then connect the cable to the MC connector at the FI-5002. Ground the unit to the hull using the shortest IV-2sq cable possible.

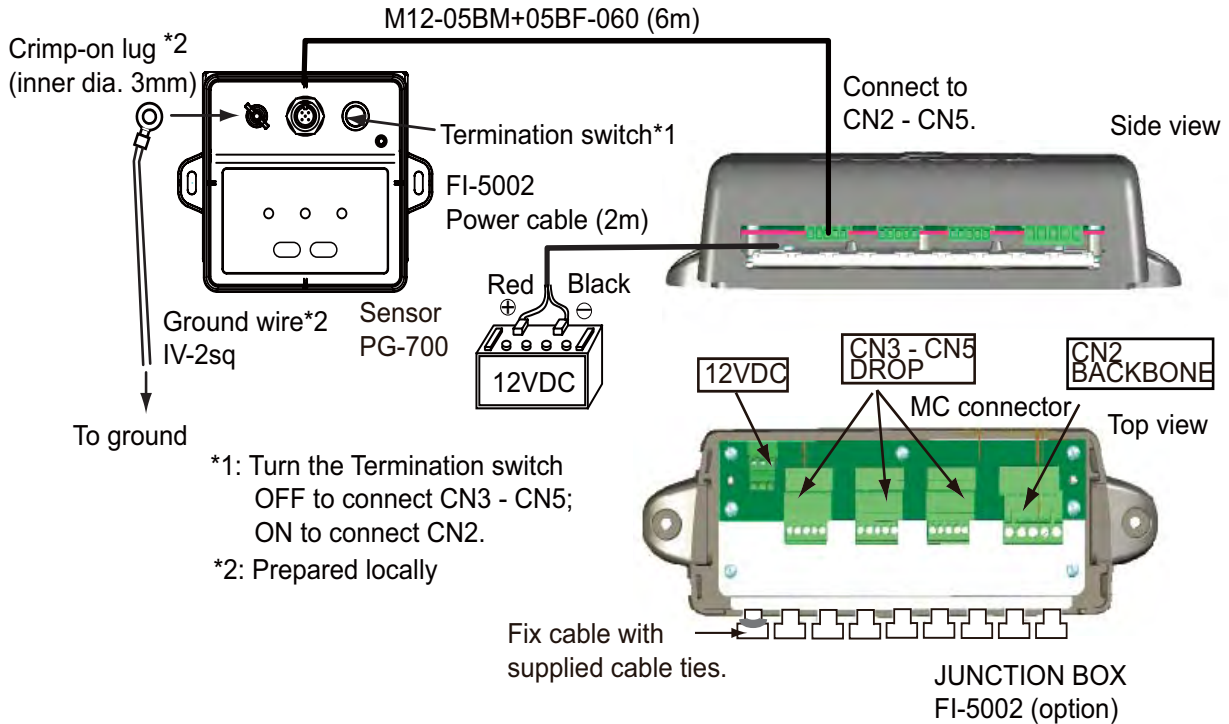

- How to fabricate cable M12-05BM+05BF-060 and connect MC connector

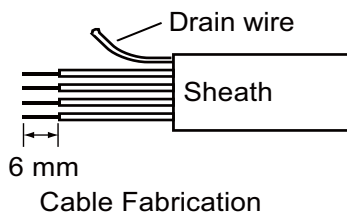

Wire	Conn. Pt.
Drain	1
RED	2
BLK	3
WHT	4
BLU	5

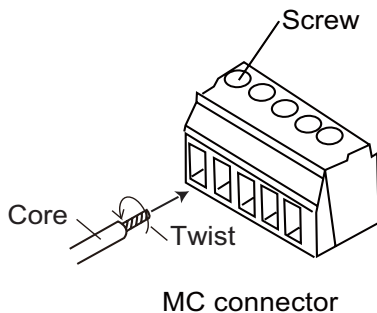

How to insert cores:

1. Twist core.
2. Unfasten screw with flathead screwdriver.
3. Set core to hole.
4. Tighten screw.
5. Pull wire to confirm connection.

If connecting directly to the instrument

When connecting FI-502/FI-504/FI505 instruments, use supplied cable M12-05BM+05BF-060. Do not cut the cable. Turn on the PG-700 termination switch.

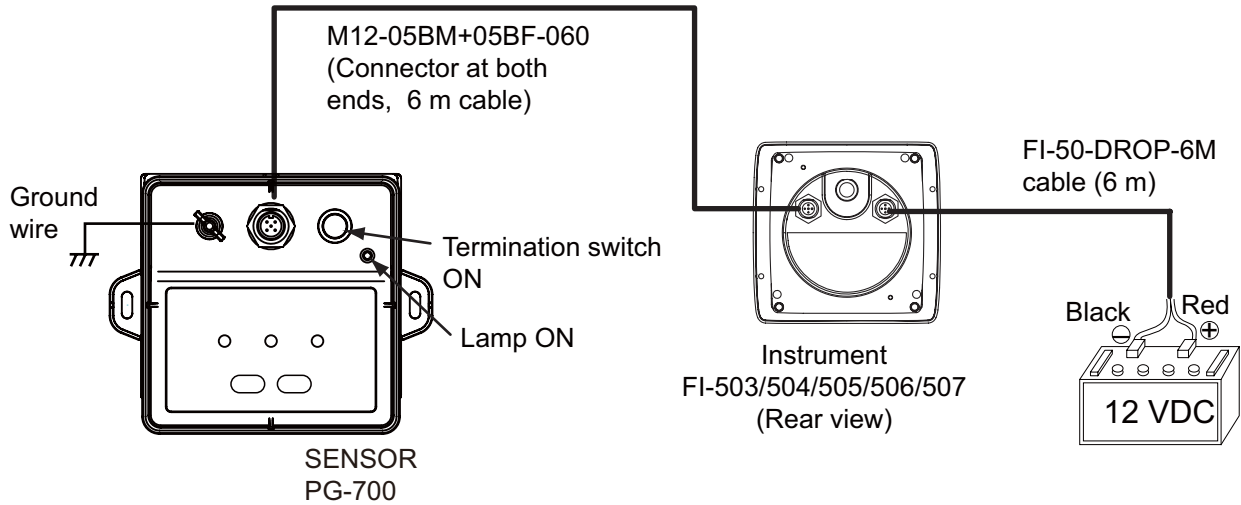

If connecting to NavNet 3D network

- If connecting M12-05BM+05BF-060 as a drop cable to a T-type connector below, turn the termination switch off.

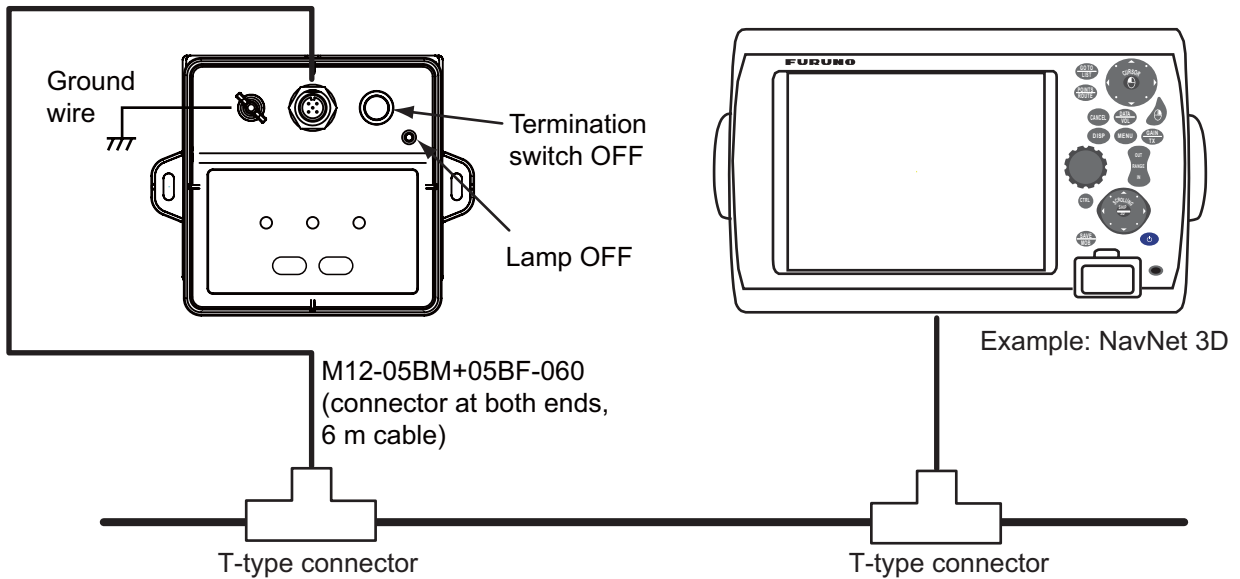

1. HOW TO INSTALL THE EQUIPMENT

- If connecting M12-05BM+05BF-060 cable to a T-type connector as a backbone, as shown below, turn the termination switch on.

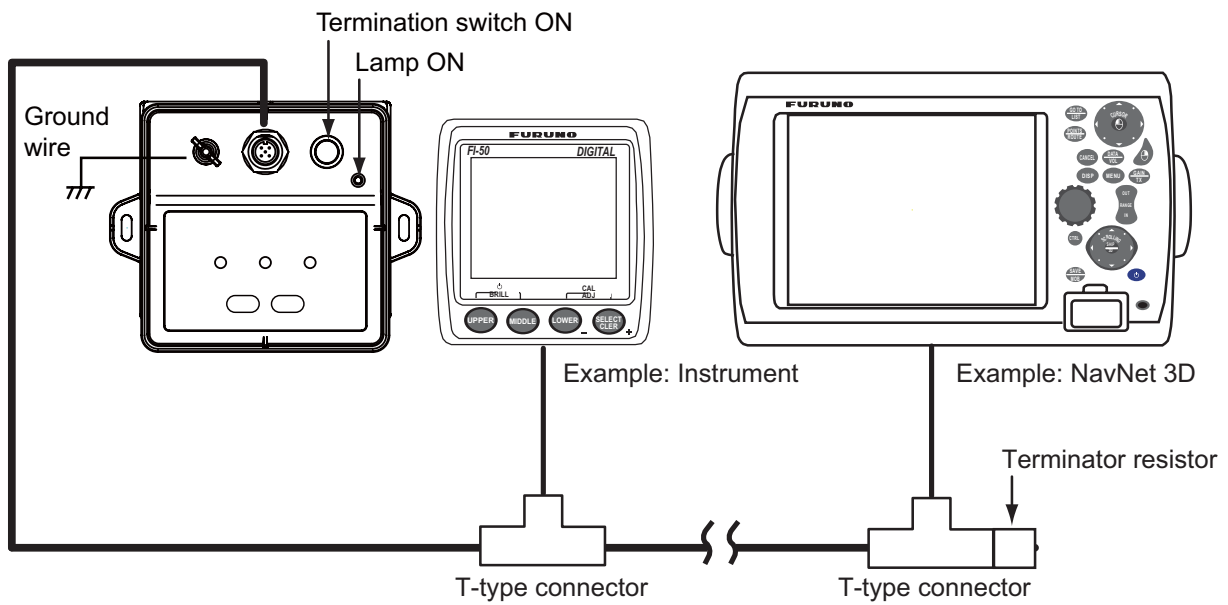

Termination switch

This switch is set according to the network topology. Generally, turn on the switch at the end of the backbone cable. When ON, the lamp lights green.

1.3 Compensation of Deviation

The unit's magnetic sense of direction may be affected by the metal of the vessel (including engines and power cables) as well as metal machinery or equipment on board. This discrepancy between true magnetic north and the indication of the unit is called "deviation". Deviation may cause incorrect heading data. The unit has the ability to automatically correct the deviation.

Note: In order to ensure the correct output orientation to a connected device, be sure to correct the deviation.

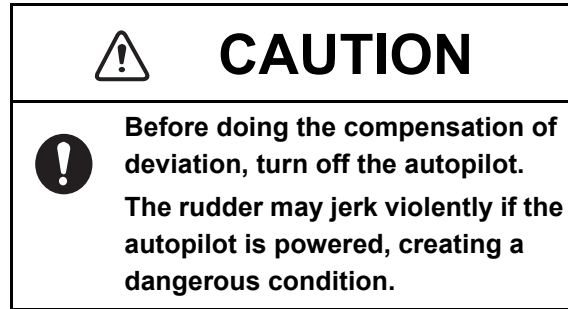

After finishing the installation completely, do the compensation of deviation in calm sea conditions as follows:

1. Turn the PG-700 on and verify that the STATUS lamp is not lit red.
2. Press and hold the [+] and [-] key together for 3 seconds, and release both keys. Deviation correction starts. The CALIB lamp flashes, and the STATUS and CHECK lamps turn off.

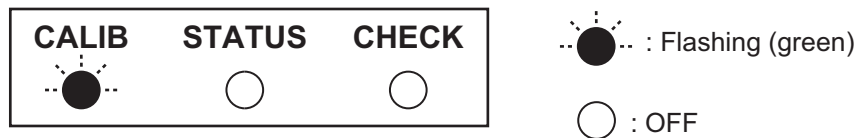

3. Turn the ship in as accurate a circle as possible, at a constant speed. Steer in a controlled circle at approx. three knots, for about two minutes. It does not matter if you turn in a left or right direction.

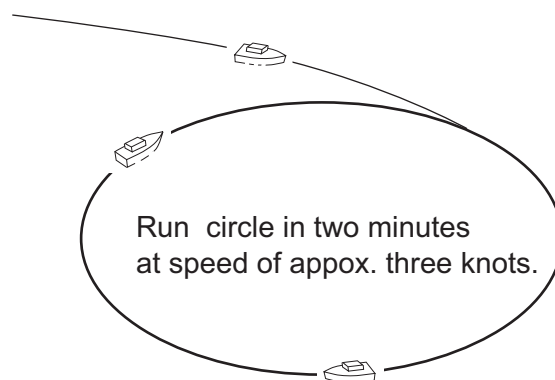

Note 1: Turning too fast may cause a large bearing error after the deviation correction.

Note 2: Be sure not to turn off the power to the switchboard when fixing deviation. Damage of data may occur.

4. Continue turning until deviation correction is completed (about 3 to 5 turns). When deviation correction is successful, the CALIB and STATUS lamps light for five seconds and the initialization of the angular velocity sensor starts. After all lamps light, go to step 6.

1. HOW TO INSTALL THE EQUIPMENT

Note: When doing deviation correction, the surrounding environment and ship position will have an effect on the time it takes to succeed in the correction.

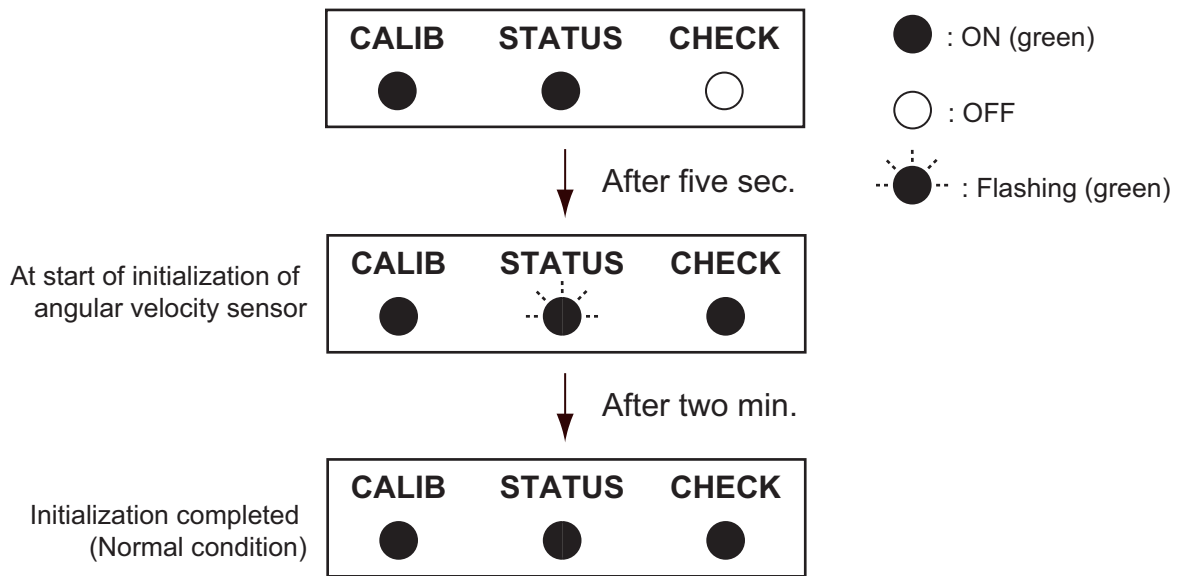

Successful status for deviation correction

If deviation correction fails, the CALIB lamp lights green and the STATUS lamp lights red. The deviation correction results remain until you proceed to step 5.

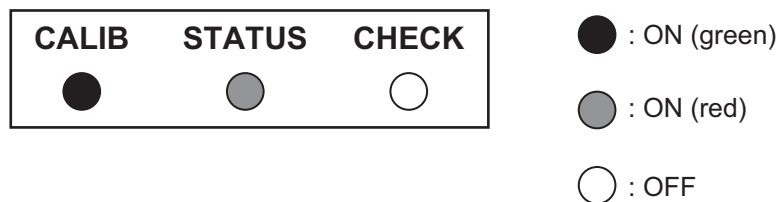



Failed status for deviation correction

5. If deviation correction fails, press the [+] and [-] keys simultaneously for 3 seconds to repeat the process again from the beginning.
6. Anchor the vessel to a quay. Point the vessel toward a stationary object (lighthouse, etc., a bearing which you can confirm on a nautical map) and confirm the bearing indication is correct. If it is not correct, measure the difference correctly and go to the procedure in section 1.4.

1.4 Heading Adjustment

The amount of adjustment required for the heading depends on the outcome of the previous section [1.3 Compensation of Deviation]. Do the following to correct the discrepancy.





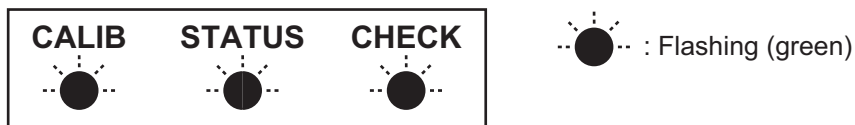































 <h3 style="margin: 0;">CAUTION</h3>
<p> Before doing the heading adjustment, turn off the autopilot.</p> <p>The rudder may jerk violently if the autopilot is powered, creating a dangerous condition.</p>

1. Press the [+] or [-] key. All lamps flash green and the unit enters heading adjustment mode.



Note: Perform step 2 within five seconds. Heading adjustment mode stays active for 5 seconds after the key is pressed. If you do nothing, the unit returns to normal mode automatically.

2. Use the [+] or [-] key to adjust the difference between the sensor output heading and the actual heading.
Heading can be adjusted at intervals of 0.1° or 1.0°. (see table below).

Key	Set interval	Lamp Status																		
Short press [-] key within 5 seconds	-0.1° (decreases 0.1° with every press)	<p>Each time you press the [-] key, the STATUS lamp will light on and off.</p> <p>1st time</p> <table border="1" style="margin-left: 40px; border-collapse: collapse;"> <tr><td style="text-align: center;">CALIB</td><td style="text-align: center;">STATUS</td><td style="text-align: center;">CHECK</td></tr> <tr><td style="text-align: center;"></td><td style="text-align: center;"></td><td style="text-align: center;"></td></tr> </table> <p>2nd time</p> <table border="1" style="margin-left: 40px; border-collapse: collapse;"> <tr><td style="text-align: center;">CALIB</td><td style="text-align: center;">STATUS</td><td style="text-align: center;">CHECK</td></tr> <tr><td style="text-align: center;"></td><td style="text-align: center;"></td><td style="text-align: center;"></td></tr> </table> <p>3rd time</p> <table border="1" style="margin-left: 40px; border-collapse: collapse;"> <tr><td style="text-align: center;">CALIB</td><td style="text-align: center;">STATUS</td><td style="text-align: center;">CHECK</td></tr> <tr><td style="text-align: center;"></td><td style="text-align: center;"></td><td style="text-align: center;"></td></tr> </table> <p style="text-align: center;">⋮</p> <p>Repeats</p>	CALIB	STATUS	CHECK				CALIB	STATUS	CHECK				CALIB	STATUS	CHECK			
CALIB	STATUS	CHECK																		
																				
CALIB	STATUS	CHECK																		
																				
CALIB	STATUS	CHECK																		
																				
Long press [-] key within 5 seconds	-1.0° (decreases in 1.0° increments while key is pressed)	<table border="1" style="margin-left: 40px; border-collapse: collapse;"> <tr><td style="text-align: center;">CALIB</td><td style="text-align: center;">STATUS</td><td style="text-align: center;">CHECK</td></tr> <tr><td style="text-align: center;"></td><td style="text-align: center;"></td><td style="text-align: center;"></td></tr> </table>	CALIB	STATUS	CHECK															
CALIB	STATUS	CHECK																		
																				

1. HOW TO INSTALL THE EQUIPMENT

Key	Set interval	Lamp Status																		
Short press [+] key within 5 seconds	+0.1° (increases 0.1° with every press)	Each time you press the [+] key, the STATUS lamp will light on and off. 1st time <table border="1" style="display: inline-table; vertical-align: middle;"><tr><td>CALIB</td><td>STATUS</td><td>CHECK</td></tr><tr><td>○</td><td>○</td><td>●</td></tr></table> 2nd time <table border="1" style="display: inline-table; vertical-align: middle;"><tr><td>CALIB</td><td>STATUS</td><td>CHECK</td></tr><tr><td>○</td><td>●</td><td>●</td></tr></table> 3rd time <table border="1" style="display: inline-table; vertical-align: middle;"><tr><td>CALIB</td><td>STATUS</td><td>CHECK</td></tr><tr><td>○</td><td>○</td><td>●</td></tr></table> ... Repeat	CALIB	STATUS	CHECK	○	○	●	CALIB	STATUS	CHECK	○	●	●	CALIB	STATUS	CHECK	○	○	●
CALIB	STATUS	CHECK																		
○	○	●																		
CALIB	STATUS	CHECK																		
○	●	●																		
CALIB	STATUS	CHECK																		
○	○	●																		
Long press [+] key within 5 seconds	+1.0° (increases in 1.0° increments while key is pressed)	<table border="1" style="display: inline-table; vertical-align: middle;"><tr><td>CALIB</td><td>STATUS</td><td>CHECK</td></tr><tr><td>○</td><td>●</td><td>●</td></tr></table>	CALIB	STATUS	CHECK	○	●	●												
CALIB	STATUS	CHECK																		
○	●	●																		

● : ON (green) ● (with dots) : Flashing (green) ○ : OFF

For example, in the case that the bearing displayed on a instrument connected to the unit is 70°, and the actual bearing is 75°, there is a 5° difference. To set to +5°, press and hold the [+] key.

- To exit heading adjustment mode, do not press any key for five seconds. The unit automatically returns to normal status.

Note: Press and hold the [+] and [-] keys for approx. one second at the lamp status after step 1 to reset to 0.

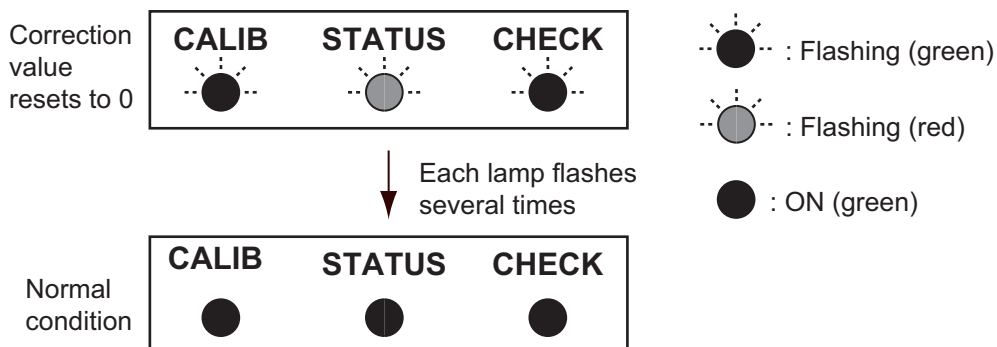

1.5 Input/Output Data List

This unit uses the following input/output data

Input/output	Specification	Remark
Input	ISO request (PGN: 059904)	PGN send request
	Address claim (PGN: 060928)	Address request
	Self Test Group Function (PGN: 061184)	Self test request
	Memory Clear Group Function (PGN: 126720)	Corresponding to clear all
	Reset Group Function (PGN: 126720)	Corresponding to reset all
	NMEA-Request Group Function (PGN: 126208)	
	NMEA-Command Group Function (PGN: 126208) + (PGN: 130818, #4) + (PGN: 065283, #4, #5, #6, #7)	Input bearing adjustment Change setting Specific setting
Output	Vessel Heading (PGN: 127250)*1 Magnetic Compass Status (PGN: 065284)*2	Regular output. 100 ms (default) 1sec.
	ISO Acknowledgement (PGN: 059392) ISO Request (PGN: 059904) Address Claim (PGN: 060928) NMEA Acknowledge (PGN: 126208) PGN List (PGN: 126464) Product Information (PGN: 126996) Self Test Report (PGN: 130816)*2 Heading & Attitude Sensor Control Status (PGN: 130818)*2 Unit Division Code (PGN: 130822)*2 Browser Control Status (PGN: 130823)*2 Magnetic Compass Control Status (PGN: 065283)*2 Rate Gyro Data (PGN: 065285) *1*2 GMM Message (PGN: 126720, #4=4)*2	Irregular output. (Send only when there is a request during startup and changes). Displays each setting

PGN: Parameter Group Number. Equivalent to NMEA0183 sentence.

*1: Data can be output at an interval of 25ms and over (5ms steps) according to the request from another device.

*2: PGN registered to Furuno Electric Co. Ltd.

2. OPERATION

Before operating:

- This unit contains magnetic components. Keep away from metals (when the ship inclines, be sure no metal objects roll towards the PG-700).
- When navigating in the vicinity of large structures (bridges, etc.), an bearing error may occur.
- If the distance between the unit and metal objects or magnets changes, an error may occur. In that case, the deviation correction may have to be set again (see section 1.3).
- Do not disconnect power when using the automatic steering system.

2.1 Key and Lamp Explanation

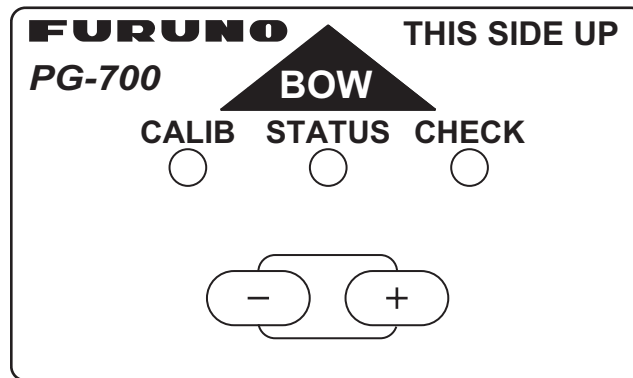

Lamp	Lamp state	Color	Key	Function
CALIB	These lamps turn on, off, or flash with equipment state. (See section 3.2)	Green	-	• Push together for seven seconds to determine suitability of installation location.
STATUS		Green, Red		+
CHECK		Green		• Push either key to get to the Heading adjustment mode.

Termination switch

The termination switch is turned on or off at installation. DO NOT change the setting.

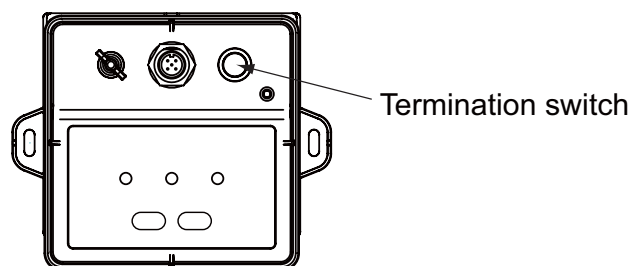

2.2 How to Turn on the PG-700

The unit has no power switch. Supply the +12 VDC power via the optional junction box FI-5002 or FURUNO CAN bus device. When power is received by the sensor, the unit will automatically check ROM and RAM status. After this, the lamps light as shown below:

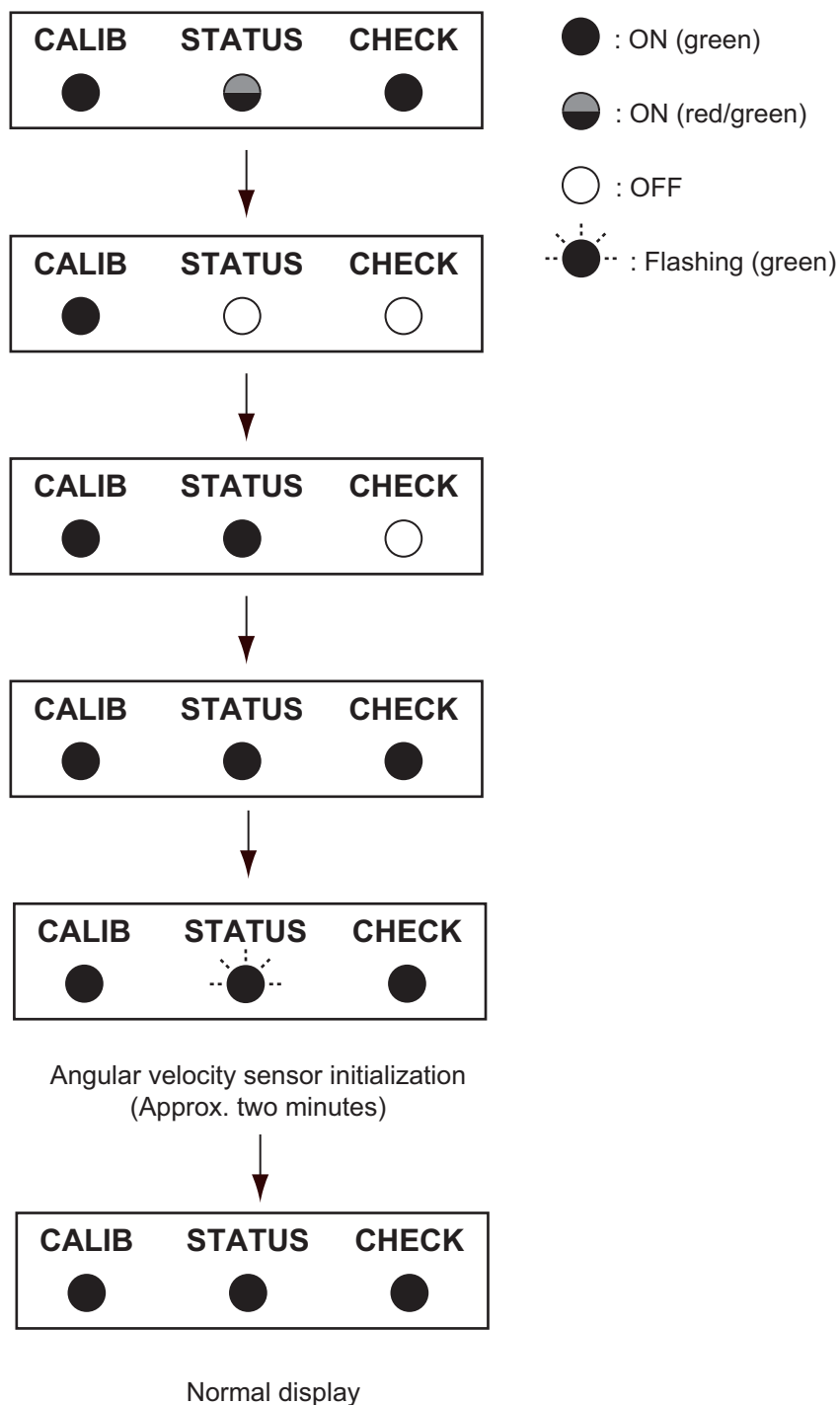

Note: If there is a problem with the ROM and/or RAM, the CALIB and CHECK lamps turn off, and the STATUS lamp flashes red. Contact your dealer.

3. MAINTENANCE AND TROUBLE-SHOOTING

This chapter discusses maintenance and troubleshooting procedures to ensure optimal performance of the equipment.

NOTICE
<p>Do not apply paint, anti-corrosive sealant or contact spray to plastic parts or equipment coating.</p> <p>Those items contain products that can damage plastic parts and equipment coating.</p>

3.1 General Maintenance

To maintain full performance of the equipment, periodic inspection is required. Refer to the following table:

Inspection item	Checkpoint	Action
Cable	Check that cable is securely connected and there is no rust or corrosion.	If necessary, reconnect the cable or replace if damaged.
Ground Terminal	Ensure the ground terminal is free of rust and not loose.	Tighten the terminal and clean off rust.
Sensor Unit	Make sure the unit is free of dust and dirt.	Wipe off dust and dirt with a soft, dry cloth. You may use a cloth moistened with a diluted detergent. Do not use thinner, acetone, alcohol, benzene, or any plastic solvent, as they may remove markings from the panel.

3.2 Lamp status display

Lamp Status	Unit operating condition						
<table border="1" style="width: 100%; border-collapse: collapse; text-align: center;"> <tr> <td style="padding: 2px 5px;">CALIB</td> <td style="padding: 2px 5px;">STATUS</td> <td style="padding: 2px 5px;">CHECK</td> </tr> <tr> <td style="padding: 5px 0 5px 5px;">●</td> <td style="padding: 5px 0 5px 5px;">●</td> <td style="padding: 5px 0 5px 5px;">●</td> </tr> </table>	CALIB	STATUS	CHECK	●	●	●	<p>Normal state</p> <ul style="list-style-type: none"> • Deviation correction: success • Angular velocity sensor: initialization complete
CALIB	STATUS	CHECK					
●	●	●					

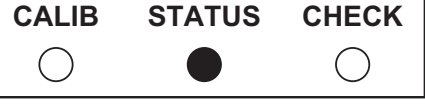
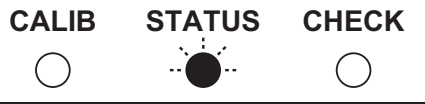
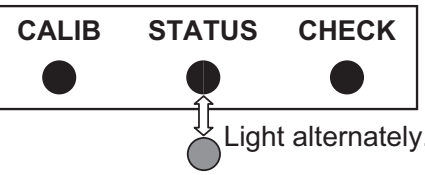
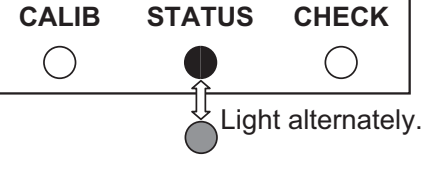
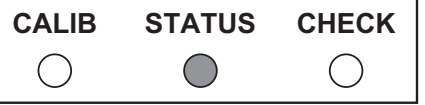
Lamp Status	Unit operating condition
	<ul style="list-style-type: none"> • Deviation correction: success • Angular velocity sensor: initializing
	<ul style="list-style-type: none"> • Deviation correction: not implemented (or failed) • Angular velocity sensor: initialization complete
	<ul style="list-style-type: none"> • Deviation correction: not implemented (or failed) • Angular velocity sensor: initializing
	<ul style="list-style-type: none"> • Deviation correction: success • Angular velocity sensor: failure • Heading data output of the magnetic sensor only
	<ul style="list-style-type: none"> • Deviation correction: not implemented (or failure) • Angular velocity sensor: failure • Heading data output of the magnetic sensor only
	<ul style="list-style-type: none"> • Magnetic bearing sensor: failure • No output of magnetic bearing data

 : ON (green)
  : ON (red)
  : OFF
  : Flashing (green)

3.3 Troubleshooting

If a problem occurs, first do the following inspections. If the problem persists, contact the dealer or a qualified service technician.

Problem	Action
Lamps do not light.	<ul style="list-style-type: none"> • Check to ensure the connector is tightened. • Check to ensure the cable is not corroded. • Check to ensure the cable is not damaged. • Check that the routing of the power supply is functioning properly.
Red lamp is on.	Turn the power on and off several times. If the red lamp remains lit, contact your dealer.
No magnetic bearing data.	<ul style="list-style-type: none"> • Turn the power on and off several times. If the problem persists, contact your dealer. • Check the terminal switch.

3.4 How to restore default settings

You can revert the unit to factory settings by doing the following:

1. Disconnect the cable from the unit.
2. Press and hold the [-] key, and reconnect the cable. Continue pressing the [-] key until step 3 is completed. Power is applied to the unit, all lamps flash. When initialization is completed, all lamps light.

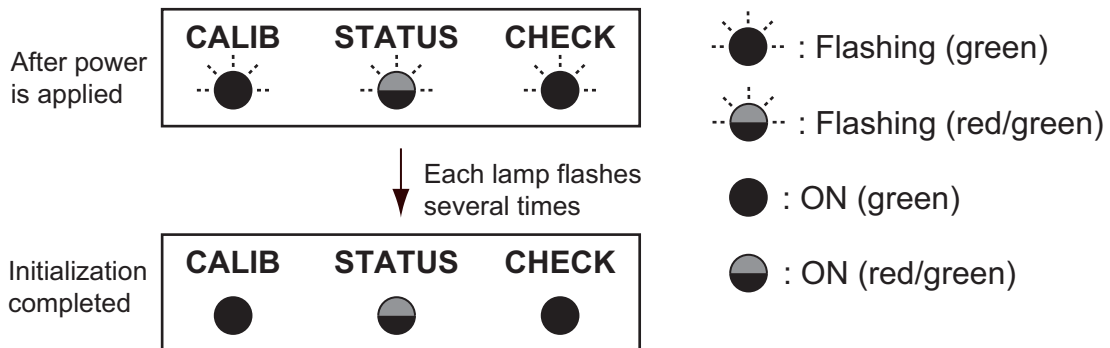

3. When all lamps light, stop pressing the [-] key.
4. To return to normal state, reconnect the unit cable.

SPECIFICATIONS OF INTEGRATED HEADING SENSOR PG-700

1 GENERAL

1.1 Heading Accuracy	±1.0° (horizontal) ±10.0° (within 30°), ±20.0° (within 45°)
1.2 Display resolution	0.1°
1.3 Follow-up	100°/s rate-of turn
1.4 Interface	CAN bus: 1 channel
Output PGN	126720
Input settings	Output interval, Bearing offset
1.5 Data Update	25 ms max. (default: 100 ms)
1.6 Delay	Within 75 ms

2 POWER SOURCE

12 VDC: 0.1 A (LEN: 3)

3 ENVIRONMENTAL CONDITION

3.1 Ambient Temperature	-15°C to +55°C
3.2 Relative Humidity	95% at 40°C
3.3 Waterproof	IP55 (IEC 60529), CFR-46 (USCG standard)
3.4 Vibration	IEC 60945

4 UNIT COLOR

N3.0

This page is intentionally left blank .



表 1 TABLE 1

寸法区分 (mm) DIMENSION	公差 (mm) TOLERANCE
$L \leq 50$	± 1.5
$50 < L \leq 100$	± 2.5
$100 < L \leq 500$	± 3

長丸穴
2-4.5x11.5
OVAL HOLE

船首方向
BOW

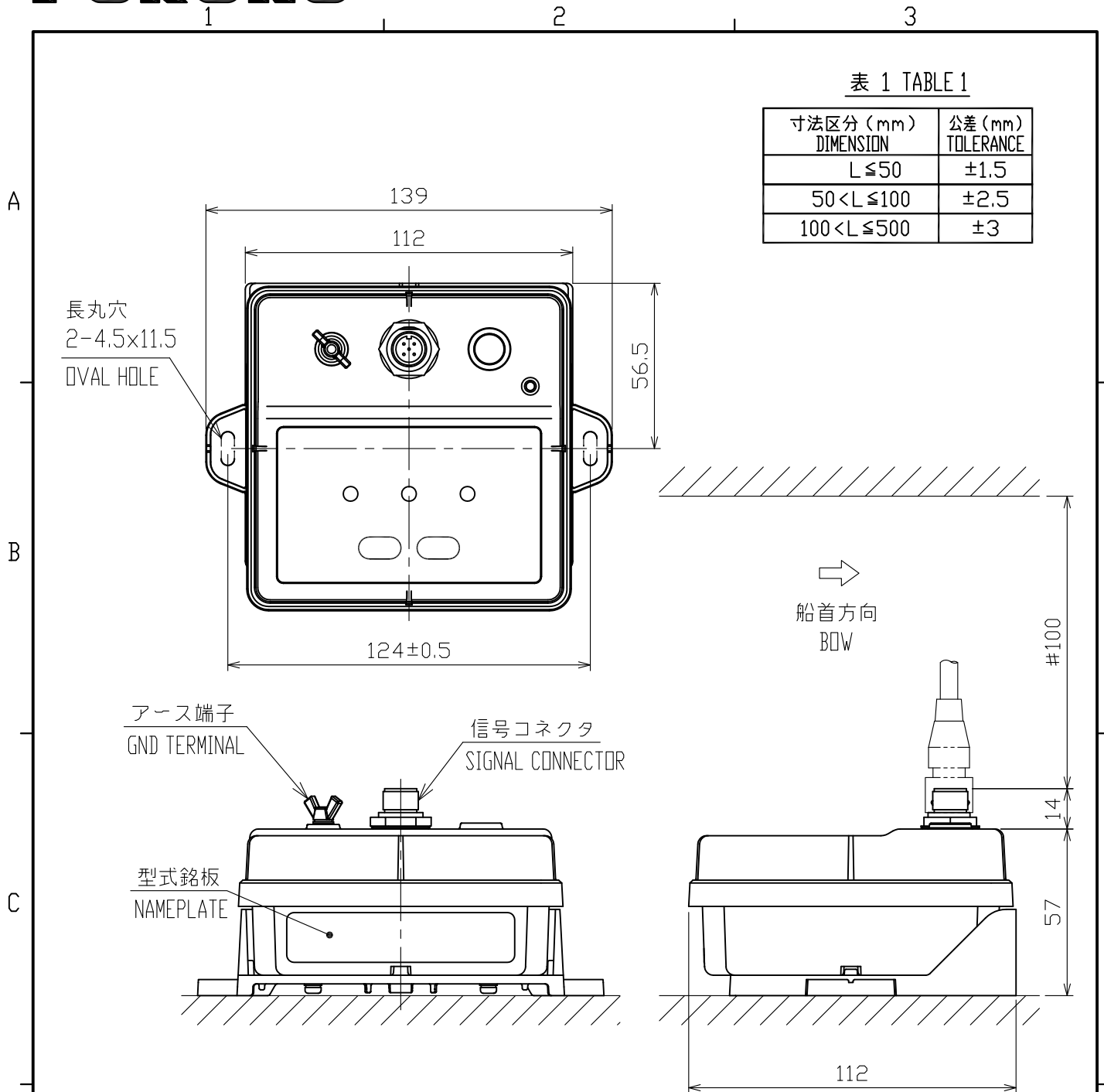
アース端子
GND TERMINAL

信号コネクタ
SIGNAL CONNECTOR

型式銘板
NAMEPLATE

注 記

- 1) 指定外の寸法公差は表 1 による。
- 2) #印寸法は最小サービス空間寸法とする。
- 3) 取付用ネジはトラスタッピンネジ呼び径 4×16 を使用のこと。
- 4) 船首線に対して平行 ($\pm 10^\circ$ 以内)、かつ水平 ($\pm 5^\circ$ 以内) となる場所に取り付けること。

NOTE

1. TABLE 1 INDICATES TOLERANCE OF DIMENSIONS WHICH IS NOT SPECIFIED.
2. #: MINIMUM SERVICE CLEARANCE.
3. USE TAPPING SCREWS $\phi 4 \times 16$ FOR FIXING THE UNIT.
4. MOUNT PARALLEL WITH THE FORE/AFT LINE ($\pm 10^\circ$) AND HORIZONTAL PLANE ($\pm 5^\circ$).

DRAWN	28/Aug/09 T.YAMASAKI	TITLE	PG-700
CHECKED	28/Aug/09 T.TAKENO	名称	ハイブリッド Heading センサー (卓上装備)
APPROVED	4/Sep/09 R.Esumi		外寸図
SCALE	MASS 0.31 $\pm 10\%$ kg	NAME	INTEGRATED HEADING SENSOR (TABLETOP MOUNT)
DWG. No.	C7276-G01-B	REF. No.	64-031-100G-1
		OUTLINE DRAWING	



表 1 TABLE 1

寸法区分 (mm) DIMENSION	公差 (mm) TOLERANCE
$L \leq 50$	± 1.5
$50 < L \leq 100$	± 2.5
$100 < L \leq 500$	± 3

注 記

- 1) 指定外の寸法公差は表 1 による。
- 2) #印寸法は最小サービス空間寸法とする。
- 3) 取付用ネジはトラスタッピンネジ呼び径 4×16 を使用のこと。
- 4) 船首線に対して平行 ($\pm 10^\circ$ 以内)、かつ水平 ($\pm 5^\circ$ 以内) となる場所に取り付けること。

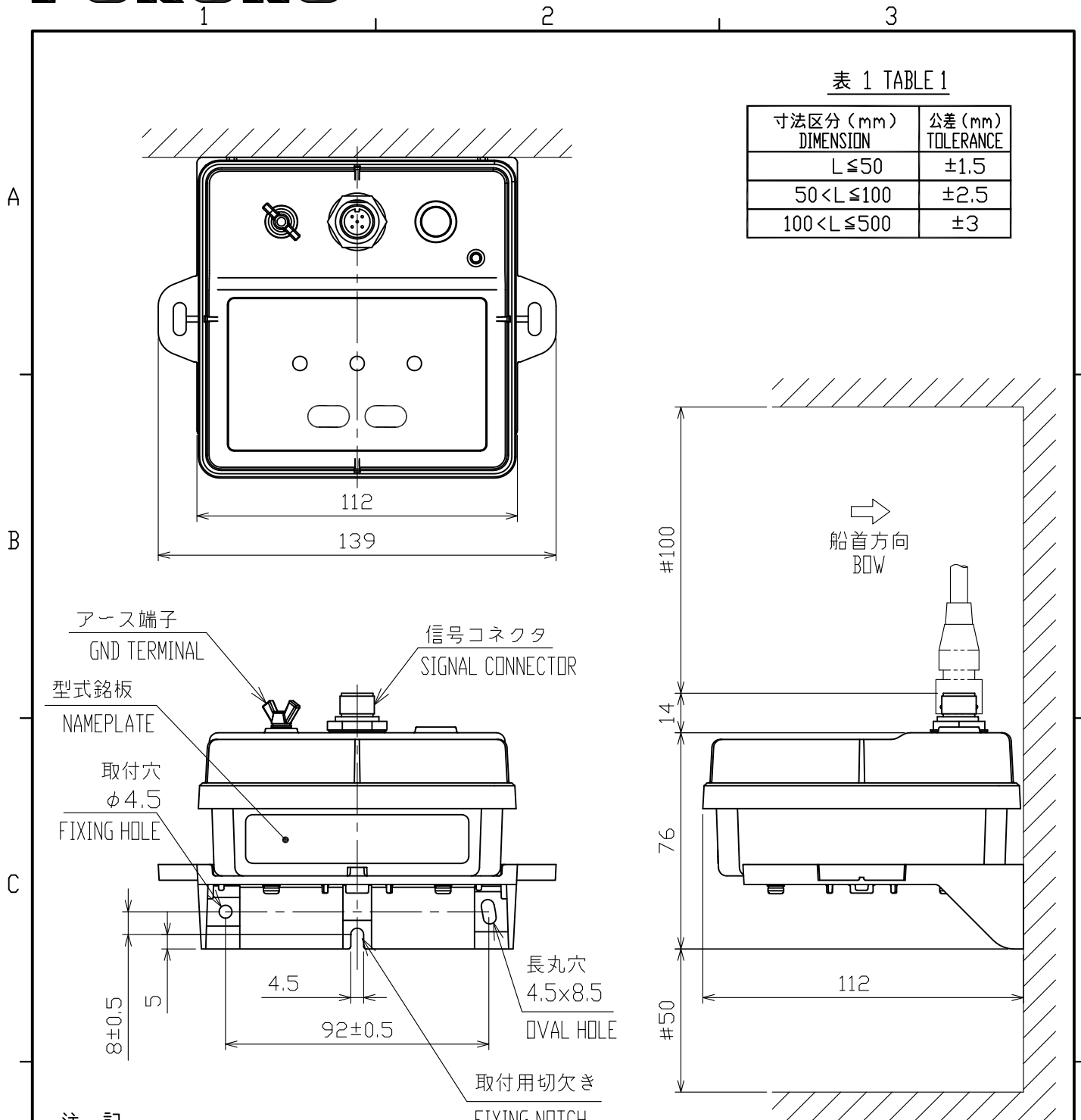
NOTE

1. TABLE 1 INDICATES TOLERANCE OF DIMENSIONS WHICH IS NOT SPECIFIED.
2. #: MINIMUM SERVICE CLEARANCE.
3. USE TAPPING SCREWS $\phi 4 \times 16$ FOR FIXING THE UNIT.
4. MOUNT PARALLEL WITH THE FORE/AFT LINE ($\pm 10^\circ$) AND HORIZONTAL PLANE ($\pm 5^\circ$).

DRAWN	28/Aug/09 T.YAMASAKI	TITLE	PG-700
CHECKED	28/Aug/09 T.TAKENO	名称	ハイブリッド Heading センサー (壁掛装備)
APPROVED	4/Sep/09 R.Esumi		外寸図
SCALE	MASS 0.31 $\pm 10\%$ kg	NAME	INTEGRATED HEADING SENSOR (BULKHEAD MOUNT)
DWG. No.	C7276-G02-B	REF. No.	64-031-110G-1
		OUTLINE DRAWING	

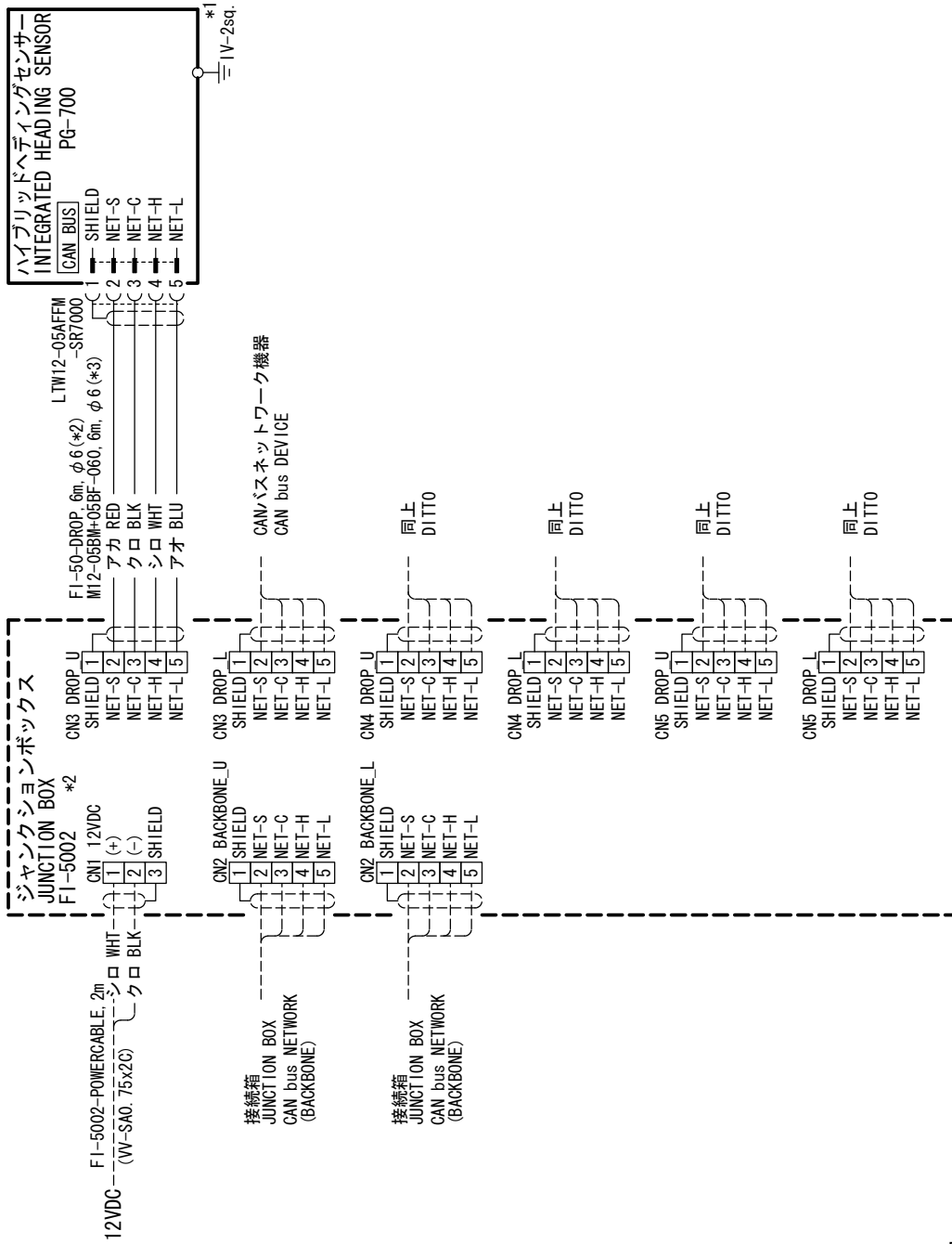

A

B

C

注記

- * 1) 造船所手配。
- * 2) オプション。
- * 3) コネクタを切り離して接続する。

NOTE

- *1: SHIPYARD SUPPLY.
- *2: OPTION.
- *3: REMOVE THE CONNECTOR FOR FABRICATION.

DRAWN	28/Jan/10	I. YAMASAKI	TITLE	PG-700
CHECKED	28/Jan/10	T. TAKENO	名称	ハイブリッドヘッド Heading センサー
APPROVED	8/Mar/10	R. Esumi		相互結線図
SCALE	MASS	kg	NAME	INTEGRATED HEADING SENSOR
DWG. No.	C7276-001-B	REF. No.	64-031-5000-0	INTERCONNECTION DIAGRAM

FURUNO Worldwide Warranty for Pleasure Boats (Except North America)

This warranty is valid for products manufactured by Furuno Electric Co. (hereafter FURUNO) and installed on a pleasure boat. Any web based purchases that are imported into other countries by anyone other than a FURUNO certified dealer may not comply with local standards. FURUNO strongly recommends against importing these products from international websites as the imported product may not work correctly and may interfere with other electronic devices. The imported product may also be in breach of the local laws and mandated technical requirements. Products imported into other countries as described previously shall not be eligible for local warranty service.

For products purchased outside of your country please contact the national distributor of Furuno products in the country where purchased.

This warranty is in addition to the customer's statutory legal rights.

1. Terms and Conditions of Warranty

FURUNO guarantees that each new FURUNO product is the result of quality materials and workmanship. The warranty is valid for a period of 2 years (24 months) from the date of the invoice, or the date of commissioning of the product by the installing certified dealer.

2. FURUNO Standard Warranty

The FURUNO standard warranty covers spare parts and labour costs associated with a warranty claim, provided that the product is returned to a FURUNO national distributor by prepaid carrier.

The FURUNO standard warranty includes:

- Repair at a FURUNO national distributor
- All spare parts for the repair
- Cost for economical shipment to customer

3. FURUNO Onboard Warranty

If the product was installed/commissioned and registered by a certified FURUNO dealer, the customer has the right to the onboard warranty.

The FURUNO onboard warranty includes

- Free shipping of the necessary parts
- Labour: Normal working hours only
- Travel time: Up to a maximum of two (2) hours
- Travel distance: Up to a maximum of one hundred and sixty (160) KM by car for the complete journey

4. Warranty Registration

For the Standard Warranty - presentation of product with serial number (8 digits serial number, 1234-5678) is sufficient. Otherwise, the invoice with serial number, name and stamp of the dealer and date of purchase is shown.

For the Onboard Warranty your FURUNO certified dealer will take care of all registrations.

5. Warranty Claims

For the Standard Warranty - simply send the defective product together with the invoice to a FURUNO national distributor. For the Onboard Warranty – contact a FURUNO national distributor or a certified dealer. Give the product's serial number and describe the problem as accurately as possible.

Warranty repairs carried out by companies/persons other than a FURUNO national distributor or a certified dealer is not covered by this warranty.

6. Warranty Limitations

When a claim is made, FURUNO has a right to choose whether to repair the product or replace it.

The FURUNO warranty is only valid if the product was correctly installed and used. Therefore, it is necessary for the customer to comply with the instructions in the handbook. Problems which result from not complying with the instruction manual are not covered by the warranty.

FURUNO is not liable for any damage caused to the vessel by using a FURUNO product.

The following are excluded from this warranty:

- a. Second-hand product
- b. Underwater unit such as transducer and hull unit
- c. Routine maintenance, alignment and calibration services.
- d. Replacement of consumable parts such as fuses, lamps, recording papers, drive belts, cables, protective covers and batteries.
- d. Magnetron and MIC with more than 1000 transmitting hours or older than 12 months, whichever comes first.
- e. Costs associated with the replacement of a transducer (e.g. Crane, docking or diver etc.).
- f. Sea trial, test and evaluation or other demonstrations.
- g. Products repaired or altered by anyone other than the FURUNO national distributor or an authorized dealer.
- h. Products on which the serial number is altered, defaced or removed.
- i. Problems resulting from an accident, negligence, misuse, improper installation, vandalism or water penetration.
- j. Damage resulting from a force majeure or other natural catastrophe or calamity.
- k. Damage from shipping or transit.
- l. Software updates, except when deemed necessary and warrantable by FURUNO.
- m. Overtime, extra labour outside of normal hours such as weekend/holiday, and travel costs above the 160 KM allowance
- n. Operator familiarization and orientation.

FURUNO Electric Company, March 1, 2011

FURUNO Warranty for North America

FURUNO U.S.A., Limited Warranty provides a twenty-four (24) months LABOR and twenty-four (24) months PARTS warranty on products from the date of installation or purchase by the original owner. Products or components that are represented as being waterproof are guaranteed to be waterproof only for, and within the limits, of the warranty period stated above. The warranty start date may not exceed eighteen (18) months from the original date of purchase by dealer from Furuno USA and applies to new equipment installed and operated in accordance with Furuno USA's published instructions.

Magnetrons and Microwave devices will be warranted for a period of 12 months from date of original equipment installation.

Furuno U.S.A., Inc. warrants each new product to be of sound material and workmanship and through its authorized dealer will exchange any parts proven to be defective in material or workmanship under normal use at no charge for a period of 24 months from the date of installation or purchase.

Furuno U.S.A., Inc., through an authorized Furuno dealer will provide labor at no cost to replace defective parts, exclusive of routine maintenance or normal adjustments, for a period of 24 months from installation date provided the work is done by Furuno U.S.A., Inc. or an AUTHORIZED Furuno dealer during normal shop hours and within a radius of 50 miles of the shop location.

A suitable proof of purchase showing date of purchase, or installation certification must be available to Furuno U.S.A., Inc., or its authorized dealer at the time of request for warranty service.

This warranty is valid for installation of products manufactured by Furuno Electric Co. (hereafter FURUNO). Any purchases from brick and mortar or web-based resellers that are imported into other countries by anyone other than a FURUNO certified dealer, agent or subsidiary may not comply with local standards. FURUNO strongly recommends against importing these products from international websites or other resellers, as the imported product may not work correctly and may interfere with other electronic devices. The imported product may also be in breach of the local laws and mandated technical requirements. Products imported into other countries, as described previously, shall not be eligible for local warranty service.

For products purchased outside of your country please contact the national distributor of Furuno products in the country where purchased.

WARRANTY REGISTRATION AND INFORMATION

To register your product for warranty, as well as see the complete warranty guidelines and limitations, please visit www.furunousa.com and click on "Support". In order to expedite repairs, warranty service on Furuno equipment is provided through its authorized dealer network. If this is not possible or practical, please contact Furuno U.S.A., Inc. to arrange warranty service.

FURUNO U.S.A., INC.
Attention: Service Coordinator
4400 N.W. Pacific Rim Boulevard
Camas, WA 98607-9408
Telephone: (360) 834-9300
FAX: (360) 834-9400

Furuno U.S.A., Inc. is proud to supply you with the highest quality in Marine Electronics. We know you had several choices when making your selection of equipment, and from everyone at Furuno we thank you. Furuno takes great pride in customer service.

EC Declaration of Conformity



We **FURUNO ELECTRIC CO., LTD.**

(Manufacturer)

9-52 Ashihara-Cho, Nishinomiya City, 662-8580, Hyogo, Japan

(Address)

declare under our sole responsibility that the product

Model:Hybrid Heading Sensor Type:PG-700

(Model name, type number)

to which this declaration relates is in conformity with the following standard(s) or other normative document(s)

EN 60945: 1997 (IEC 60945 Third edition: 1996-11) – Clauses 10.2 and 10.3

EN 60945: 2002 (IEC 60945 Fourth edition: 2002-08) – Clauses 9.2, 9.3, 10.3, 10.4, 10.5, 10.8 and 10.9

(title and/or number and date of issue of the standard(s) or other normative document(s))

For assessment, see

- EMC Test Report FLI 12-09-033 of 29 June 2009 prepared by Furuno Labotech International Co., Ltd.

This declaration is issued according to the Directive 2004/108/EC of the European Parliament and of the Council of 15 December 2004 on the approximation of the laws of the Member States relating to electromagnetic compatibility and repealing Directive 89/336/EEC

On behalf of Furuno Electric Co., Ltd.

Takahiko Kusuda
Manager, QMS Secretariat
Quality Assurance Department

Nishinomiya City, Japan
July 22, 2009

(Place and date of issue)

(name and signature or equivalent marking of authorized person)

ECF

(Elemental Chlorine Free)

The paper used in this manual
is elemental chlorine free.

FURUNO ELECTRIC CO., LTD.

9-52 Ashihara-cho,
Nishinomiya, 662-8580, JAPAN

• FURUNO Authorized Distributor/Dealer

All rights reserved.

Printed in Japan

A : SEP. 2009

D1 : AUG. 03, 2012

Pub. No. OME-72760-D1

(AKMU) PG-700

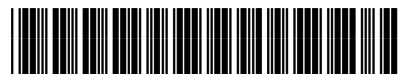

* 0 0 0 1 7 1 8 2 7 1 3 *