

**NEW!**



# NATURE PURE® QC™

## Point-of-Use Drinking Water Purifiers

General Ecology's original Nature Pure Ultrafine™ Series purifiers, introduced 20+ years ago, quickly became proven market leaders, worldwide. Continuing our tradition of innovative product evolution, General Ecology's new **Nature Pure QC2 "Quick-Change" Series purifiers**, introduces enhanced performance and great new convenience features.

**CONCEPT:** "Nature Pure QC2" Systems eliminate the need for traditional pressure vessel "housings". Instead, small, lightweight, replaceable canisters are conveniently hand-turned into compact stainless steel "interface units with integral stainless steel mounting brackets." Nature Pure QC systems are easily and conveniently integrated into watercraft, recreational vehicle and other fresh water systems. There are no V-clamps, shear rods, toggles or similar closures. And, although a manual valve should be installed nearby on the water supply line, water pressure is automatically turned off when a canister is removed from the interface unit, and turned on when a canister is hand-turned into place. **Nature Pure QC2 systems are exceptionally space saving, easy to install, operate and service, and weigh less than other systems.**

### TECHNOLOGY:

Nature-Pure QC2 purifiers feature **"Structured Matrix™" Technology** which is instantly effective against all three classes of contaminants: microbiological, chemical and aesthetic. Like all General Ecology "purification" products, Nature-Pure QC2 purifiers using NPRS2QC canister are independently certified against the three general categories of waterborne, enteric pathogens: chlorine resistant Crypto and Giardia; bacteria; and viruses. Nature-Pure QC2 systems also excel in removing foul tastes and odors and many other chemicals. Natural minerals dissolved in the water source are not removed.

All General Ecology water systems are environmentally and ecologically friendly, operating instantly without chemical additives (and associated disinfection by-products), electricity or "hold time".

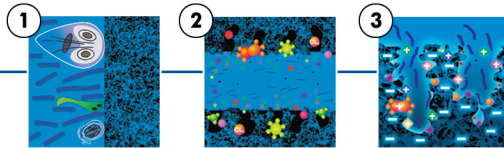

General Ecology's "Structured Matrix" technology purifies water without using harmful chemicals or electrical connections:

- 1 ULTRAFINE MICROSTRAINING** physically removes waterborne enteric disease bacteria, pathogenic cysts like Giardia, Cryptosporidia, and specific parasites and debris down to 0.4 micron.
- 2 BROAD SPECTRUM MOLECULAR CAPTURE** traps and captures many organic chemicals such as pesticides, herbicides and solvents, as well as chlorine and other trace contaminants that can be toxic and/or carcinogenic, along with foul taste, odor, and color.
- 3 ELECTROSTATIC REMOVAL** uses proprietary molecularly attractive surfaces, essentially as magnets, to remove minute particles, viruses and colloids suspended in the water.

All of these purification mechanisms work together to REMOVE viruses, disease bacteria and other contaminants far smaller than submicron microfiltration alone can remove. Performance may vary according to influent water characteristics.

Especially Ideal for  
**ICEMAKERS, RVs, SMALLER  
BOATS and FRESH WATER  
APPLICATIONS**

General Ecology, Inc. the pure science of safe water™  
151 Sheree Blvd., Exton, Pennsylvania 19341-1292 USA



800-441-8166 EST • www.generalecology.com

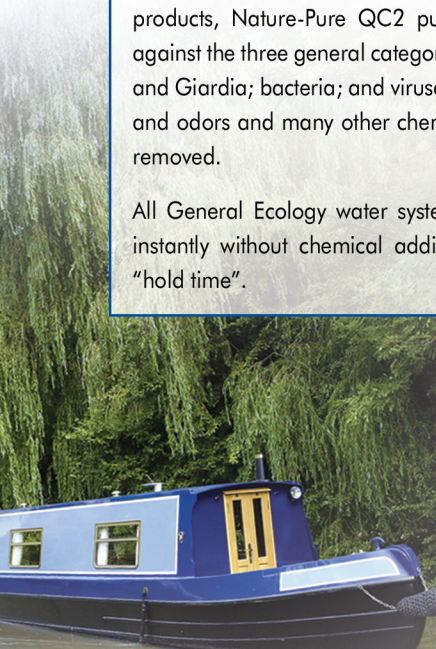





# nature pure<sup>®</sup> QC<sup>™</sup> 2 Series

## ENVIRONMENTALLY FRIENDLY WATER PURIFICATION SYSTEMS

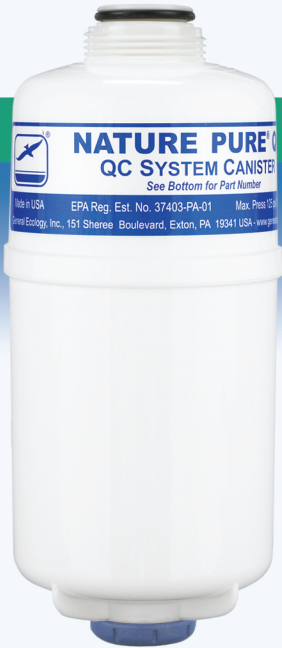

**NPRS2QC Canister**

The All New Nature Pure QC2 Series Point-of-Use Drinking Water Systems employ the proprietary "Structured Matrix"<sup>™</sup> purification technology that purifies without adding harmful chemicals or electrical connections to produce great tasting purified water instantly from fresh water sources.



**NPQC Interface with Tethered Sanitary By-pass Connector** for convenient plumbing system sanitization and winterization.

Independently certified to EPA Guide Standard Protocol for Microbiological Purifiers against Bacteria, Cysts and Viruses!

**Nature Pure QC2 Faucet system** includes interface with tethered sanitary by-pass connector, NPRS2QC Canister, "quick and easy" connection lines, and a point-of-use FP faucet with ceramic disk valving.

**Nature Pure QC2 basic system** includes Interface with tethered sanitary by-pass connector, NPRS2QC Canister, and "quick and easy" connection lines to be used with your existing faucet.

## Nature Pure QC2 System Specifications, Performance and Dimensions

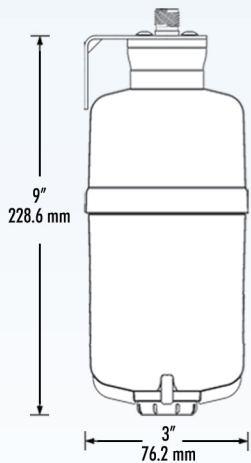

**Interface side view**

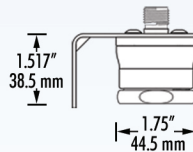

**Interface top view**

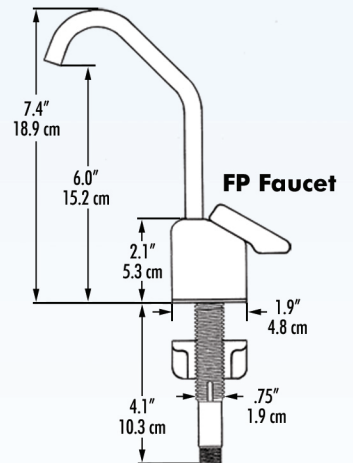
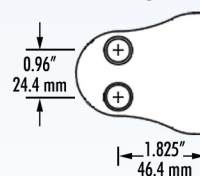

### Nature Pure QC2 System

|                                     |                            |
|-------------------------------------|----------------------------|
| NPQC2 Faucet System .....           | PN 420400                  |
| NPQC2 Basic System .....            | PN 420430                  |
| NPRS2QC Purification Canister ..... | PN 420420                  |
| Particle Retention.....             | 0.4 micron                 |
| Flow Rate .....                     | 0.8 gpm (3.0 lpm)          |
| Nominal Capacity* .....             | 800 gallons (3,000 liters) |
| Max Operating Temperature .....     | 100°F (38°C)               |
| Operating Pressure .....            | 25-100 psi                 |
| NPQC2 Faucet System Weight .....    | 0.64kg / 1.41lb            |
| NPRS2QC Canister Weight .....       | 0.44kg / 0.97lb            |

### Notes:

- 1- Nature Pure QC2 Systems should be installed close to points of use to minimize possible intrusive post-purification microbiological inoculation or other water quality degradation "downstream" of purification processes. Nature Pure QC2 systems can be installed near kitchen sinks, ice makers, and at readily accessible drinking water fountain locations. No chemicals or electrical connections.
- 2- Stainless Steel Interface Valves are certified to ASME A112.18.3M ANSI/NSF 61
- 3- Nature Pure QC2 Systems are not intended to desalinate.
- 4- Do Not Remove Nature Pure QC2 Mounting Bracket from the Interface Unit.

\* Performance may vary according to influent water quality. For Cold Water Use Only - Does Not Desalinate



Manufactured by **General Ecology, Inc.** 151 Sheree Blvd., Exton, PA 19341  
(610) 363-7900 - fax (610) 363-0412 - Customer Service 1-800-441-8166  
www.generalecology.com - info@generalecology.com