

MPPT-PRO Solar Controller

User Manual
GP-MPPT-PRO-60



© 2020 Go Power!

Worldwide Technical Support and Product Information gpelectric.com

Go Power!

201-710 Redbrick Street Victoria, BC, V8T 5J3

Tel: 1.866.247.6527

82804_MAN_GP-MPPT-PRO-60_RevA



Congratulations on purchasing your Go Power! MPPT Solar Controller!

Record the unit's model and serial number below. It is much easier and quicker to record this information now at the pre-installation stage.

Model Number:
Serial Number:
Date of Install:
Battery Bank Information: (size, install date, battery type)



Product Packaging

Please safely store the packing the product was delivered in or recycle the packaging components as outlined below:



Corrugated fiberboard
main box

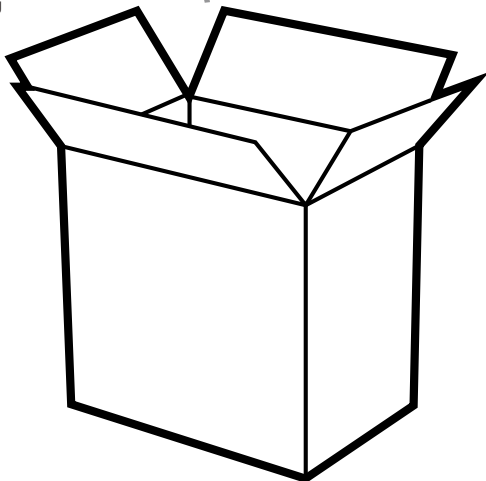

Plastic
foam protection

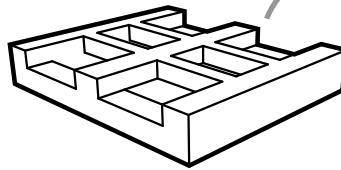

LDPE
Low Density
Polyethylene



Plastic
accessories bag

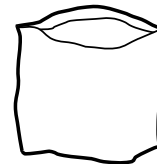

1. INTRODUCTION	5
1.1 SAFETY PRECAUTIONS	5
1.2 OVERVIEW	6
1.3 FEATURES	6
1.4 APPEARANCE	7
1.5 MPPT TECHNOLOGY	8
1.6 CHARGING STAGES	10
2. TECHNICAL PARAMETERS	11
2.1 ELECTRICAL PARAMETERS	11
2.2 BATTERY TYPE DEFAULT PARAMETERS	12
3. CONVERSION EFFICIENCY CURVE	13
3.1 12V SYSTEMS	13
3.2 24V SYSTEMS	13
4. PRODUCT DIMENSIONS	14
5. STATUS DISPLAY	14
5.1 LED INDICATION	14
5.1.1 PV INDICATOR	14
5.1.2 BATTERY INDICATOR	15
5.1.3 LOAD INDICATOR	15
5.1.4 ERROR INDICATOR	15
6. OPERATION AND DISPLAY	16
6.1 LCD MAIN INTERFACE	16
6.1.2 NAVIGATION BUTTONS	16
6.1.3 ICON DESCRIPTION	17
6.1.4 MENU BLOCK DIAGRAM	17
6.1.5 REAL-TIME MONITORING	18
6.1.6 SYSTEM PARAMETER SETTINGS	19
6.1.7 CONTROLLER CHARGING AND DISCHARGING RELATED PARAMETER SETTINGS	21
6.1.8 LCD SCREEN BACKLIGHT TIME SETTING	21
6.1.9 CONTROLLER ABNORMALITY VOICE ALARM - ON/OFF SETTING	21
6.1.10 CLEAR HISTORICAL DATA AND RESET TO FACTORY SETTINGS	22
6.1.11 LOAD MODES	22
6.1.12 STATISTIC DATA	23
6.1.13 HISTORICAL DATA OF THE CURRENT DAY	23
6.1.14 DEVICE INFORMATION	24
7. INSTALLATION	25
7.1 TOOLS AND MATERIALS NEEDED	25
7.2 INSTALLATION AND WIRING	25
7.3 WIRING FOR PARALLEL OPERATIONS	28
7.3.1 WIRING DIAGRAM	28
7.3.2 ORDER OF CONNECTION	29
7.3.3 INTERFACE DEFINITION	29
7.3.4 PARAMETER SETTING	29

8. BLUETOOTH® DONGLE	31
8.1 BLUETOOTH® ADAPTER PRODUCT INTRODUCTION	31
8.2 MAIN FEATURES	31
8.3 LED STATUS	31
8.4 APPLICABLE TYPE	31
8.5 PRODUCT FEATURES	32
8.6 PRODUCT DIMENSIONS	32
8.7 SYSTEM WIRING DIAGRAM	33
8.8 SPECIFICATIONS	33
9. REMOTE	34
9.1 PRODUCT FEATURES	34
9.2 APPEARANCE	34
9.3 INSTALLATION DIMENSIONS	35
9.4 COMMON PROBLEMS AND SOLUTIONS	35
9.5 FAULT INDICATION AND COMMUNICATION INDICATION	36
10. SYSTEM MAINTENANCE	37
10.1 ERROR AND WARNINGS	37
11. WARRANTY	38
11.1 REPAIR AND RETURN INFORMATION	38

1.1 SAFETY PRECAUTIONS

Important safety information is contained throughout this manual that should be carefully observed and followed. This information is presented using the following format.









	<p>Warning / Caution: Result Description of condition leading to result</p>
---	--

The information is categorized in two ways:

Warning: Bodily harm could occur if instructions are not explicitly followed. If there are any doubts about the procedure or conditions, please call GoPower! technical support before doing anything.

Caution: Damage to property could occur if instructions are not followed properly.

The following symbols are used to indicate the type of hazard.

SYMBOL	MEANING	SYMBOL	MEANING
	General Warning		Hot Surface
	Risk of Shock		Risk of Fire
	Risk of Electrocution		Risk of Chemicals
	Risk of Explosion		Risk of Eye Injury

GENERAL SAFETY

- Read entire manual before installation
- Any voltage above 30 VDC should be considered dangerous. Make sure power is disconnected before touching terminals that exceed this voltage.
- There are no parts inside the controller that need to be maintained or repaired. The controller shall never be disassembled
- Unless otherwise specified, all terminal blocks should be re-tightened at least every 6 months to prevent possible fire caused by connections that have vibrated loose.
- Ensure all connections are tight and secure. Loose connections may generate sparks and heat. Be sure to check connections one week after installation to ensure they are still tight.

SOLAR CONTROLLER SAFETY

- Always connect the battery BEFORE connecting the solar array to prevent damage to the controller. If the battery wires need to be disconnected, the solar array wires should first be disconnected.
- To prevent damage to the controller, ensure the solar array voltage does not exceed the maximum voltage of the solar controller. See specifications table below to determine the limit for your controller.

BATTERY SAFETY

- Ensure the battery type is set correctly in the controller settings to avoid possible explosion or fire
- Read manual for battery and observe safety precautions before connecting the battery to the controller
- Only use deep cycle batteries that are intended for energy storage applications



1.2 OVERVIEW

Solar controllers, or solar charge controllers, continuously monitors the solar panel's generating power and tracks the highest voltage and current values (VI) in real time, enabling the system to charge the battery to maximum power. It's designed to be used in off-grid solar photovoltaic systems to coordinate operation of the solar panel, battery, and load, functioning as the core control unit in off-grid photovoltaic systems.

This product features an LCD screen which displays the operating status, operating parameters, controller logs, and control system parameters. Users can conveniently check parameters using the buttons and modify control parameters to cater to different system requirements.

The controller utilizes standard Modbus communication protocol, making it easy for users to check and modify system parameters on their own. An optional Bluetooth® adapter gives users access to remote monitoring.

With comprehensive electronic fault self-detecting functions and powerful electronic protection functions built inside the controller, component damage caused by installation errors or system failures can be avoided.

1.3 FEATURES

- Advanced multi-peak tracking technology. When the solar panel is shadowed or part of the panel fails resulting in multiple peaks on the I-V curve, the controller is still able to accurately track the maximum power point.
- Built-in maximum power point tracking (MPPT) algorithm significantly increases energy utilization efficiency of the photovoltaic system, (about 15% to 20% higher than traditional PWM charging.)
- Provides an active charging voltage regulation feature. At battery open circuit or lithium battery BMS overcharge protection, the controller battery terminal will output the rated charging voltage value.
- MPPT tracking allows up to 99.9% efficiency.
- Uses advanced digital power technology to increase the circuit energy conversion efficiency to as high as 98%.
- Supports multiple battery chemistries, including lithium, sealed, vented, AGM, and flooded Lead Acid.
- Current-limited charging mode. When the power of solar panel is too large and the charging current is higher than the rated value, the controller automatically reduces the charging power so that the solar panel can operate at the rated charging current.
- Supports automatic identification of lead-acid battery voltage.
- Features LED fault indicators and an LCD screen, which can display abnormal information, helps users to quickly identify system faults.
- Historical data storage function is available, and data can be stored for up to a year
- The controller is equipped with an LCD screen allowing users to easily check device operation and statuses and modify controller parameters
- Supports standard Modbus protocol to meet different options.
- Built-in over-temperature protection ensures that when temperature exceeds the set value of the device, the charging current decreases linearly with the temperature, which reduces an increase in the controller's temperature, avoiding damage.
- Temperature compensation and automatic adjustment of charge and discharge parameters help to improve battery life.
- Solar panel short circuit protection, battery open circuit protection and TVS transient protection.

1.4 APPEARANCE

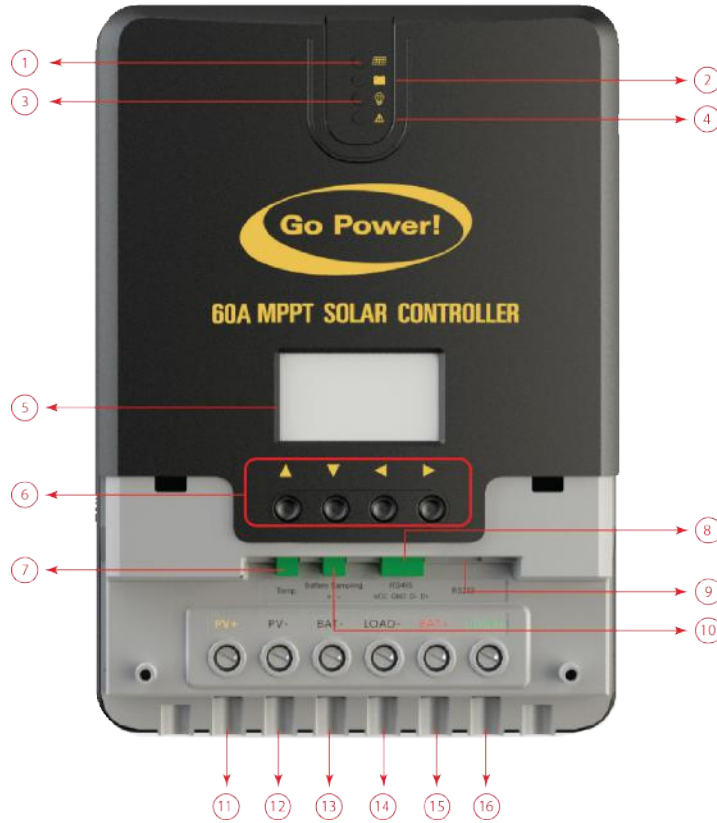

NO.	NAME	NO.	NAME
1	Charging indicator	9	Communication port
2	Battery indicator	10	Battery voltage compensation interface
3	Load indicator	11	Solar Panel "+"
4	Error indicator	12	Solar Panel "-"
5	LCD screen	13	Battery "-"
6	Operating buttons	14	Load "-"
7	External temperature sampling interface	15	Battery "+"
8	RS485 communication interface	16	Load "+"

1.5 MPPT TECHNOLOGY

Maximum Power Point Tracking (MPPT) is an advanced charging technology that more efficiently harvests power from solar panels in all conditions. It does this by continuously tracking the I-V curve of the solar array and modifying operating conditions to maximize output power. Figure 1-2 shows the MPPT point compared to a traditional PWM charger, which always runs the solar array at the same operating conditions.

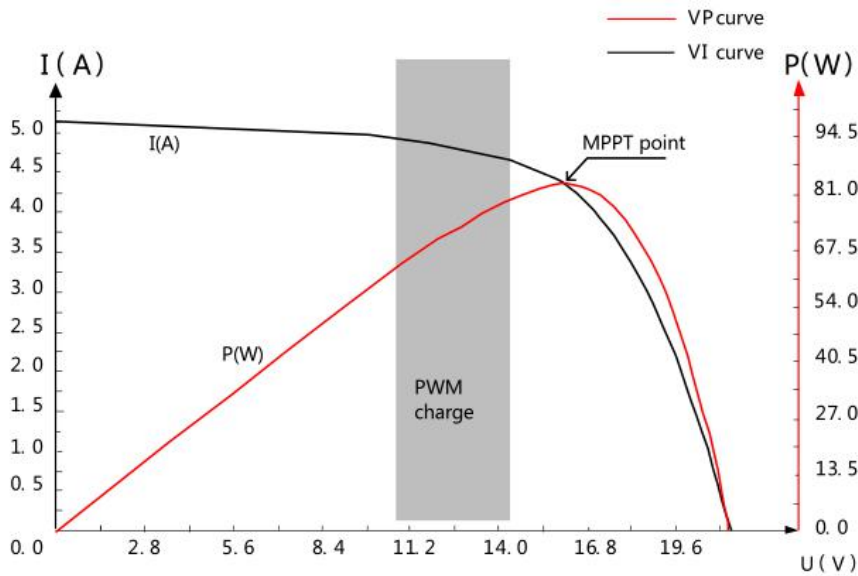

FIGURE 1-2 Solar panel output characteristics curve

Due to differences in ambient temperature and light conditions, the maximum power point often changes. The MPPT controller can adjust parameters according to quickly changing conditions to keep the system near to its maximum working point. The whole process is fully automatic and does not require any adjustments by users.

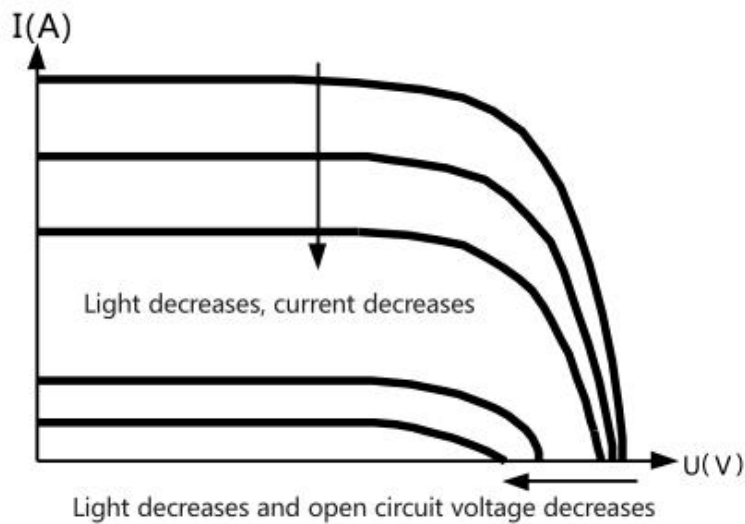

FIGURE 1-3 Relationship between solar panel output characteristics and light

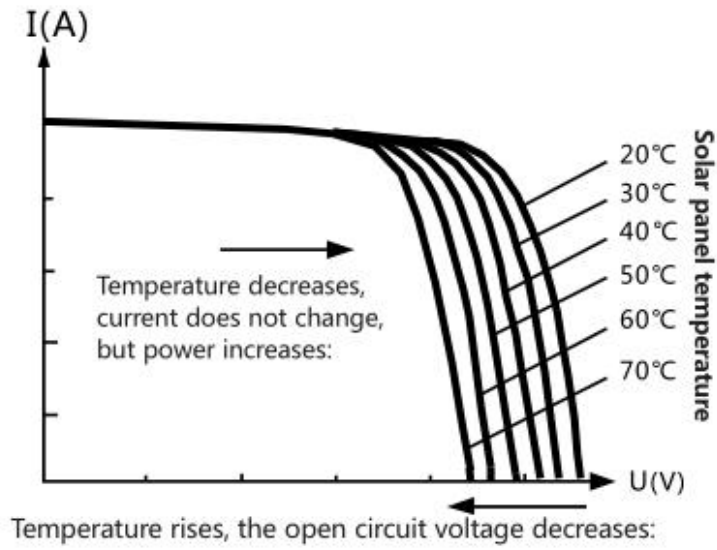
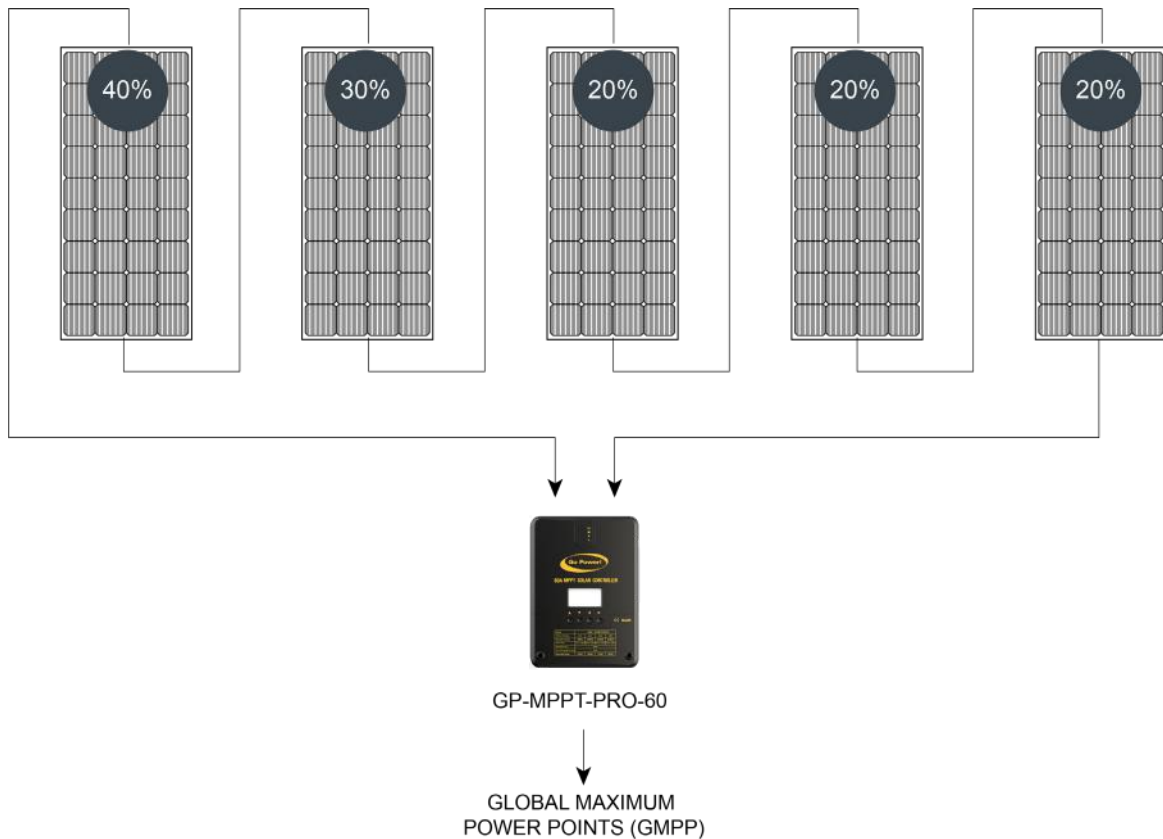
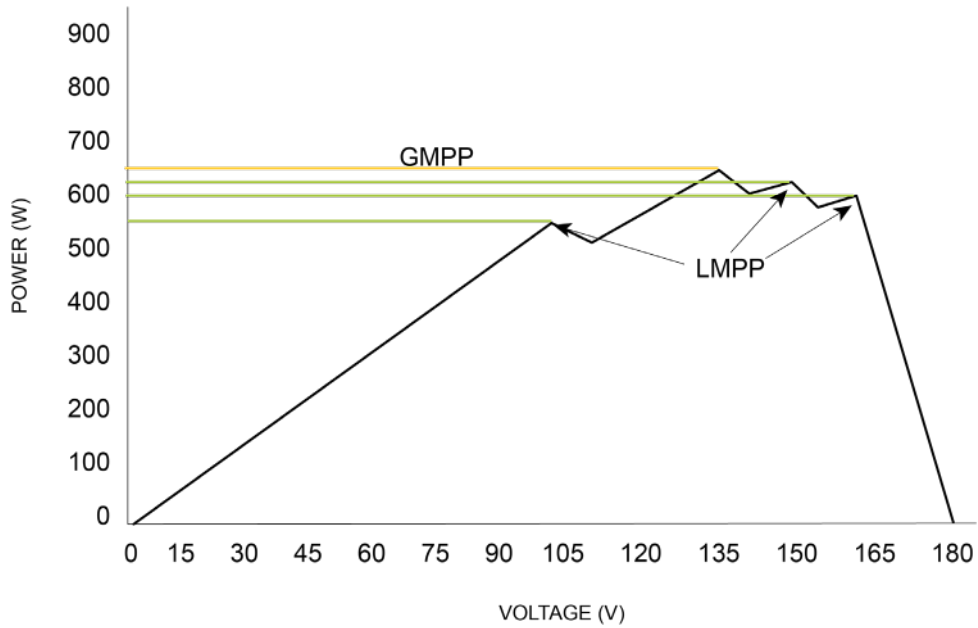

FIGURE 1-4 Relationship between solar panel output characteristics and temperature

In partially shaded conditions there can also be multiple peaks in the P-V curve that can confuse an MPPT algorithm. Shown in Figure 1-5 is a series string of solar panels and a corresponding graph that shows lower maximum power points (LMPP) and the greater maximum power point (GMPP) that will result in maximum energy transfer. The GP-MPPT-PRO series has a smart algorithm that will always choose the right peak.



(A)



(B)

FIGURE 1-5 Multiple peaks resulting from partial shading

1.6 CHARGING STAGES

Maximum power point tracking is used to charge the batteries with the highest current possible, but this is only part of the equation. A battery cannot be charged at maximum power all the time for safety reasons, so multiple stages are used. These stages include bulk, boost, float and, for some types of batteries, equalization as shown in Figure 1-6.

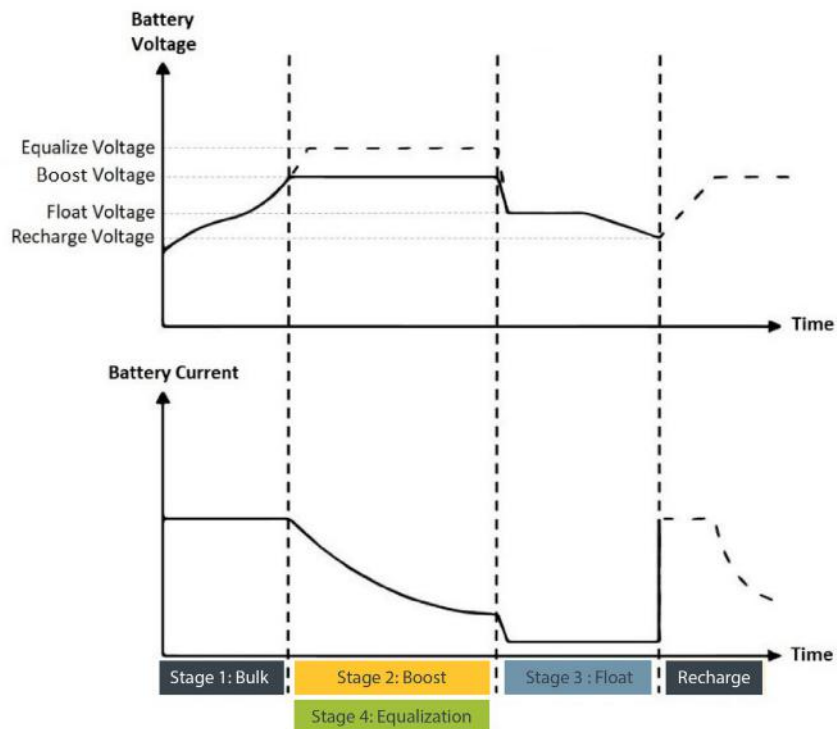

FIGURE 1-6 Battery charging stages curve graph



2. TECHNICAL PARAMETERS

2.1 ELECTRICAL PARAMETERS

ITEMS	PARAMETERS
MODEL	GP-MPPT-PRO-60
SYSTEM VOLTAGE	12V/24V
ZERO LOAD LOSS	<10mA
BATTERY VOLTAGE	9V~32V
MAXIMUM PV OPEN CIRCUIT VOLTAGE	92V(25°C); 100V(Lowest Ambient Temperature)
MAXIMUM POWER POINT VOLTAGE RANGE	(Battery voltage +2V) ~ 72V
RATED CHARGING CURRENT	60A
MAXIMUM PV INPUT POWER	1040W/12V; 2080W/24V; 3120W/36V; 4160W/48V
CHARGING CONVERSION EFFICIENCY	≤98%
MPPT TRACKING EFFICIENCY	>99%
TEMPERATURE COMPENSATION COEFFICIENT	-3mv/°C/2V (default); Lithium battery features no temperature compensation
OPERATING TEMPERATURE	-35°C ~ +45°C
IP RATING	IP32
WEIGHT	3.6kg/7.9lbs
COMMUNICATION MODE	TTL Serial communication
ALTITUDE	≤ 3000 meters
DIMENSIONS (mm)	238 x 205 x 93

STAGE 1: BULK

In quick charge stage, the battery voltage has not yet reached the set value of full charge voltage (i.e. equalizing/boost charge voltage) and the controller will perform MPPT charging, which will provide maximum solar energy to charge the battery. When the battery voltage reaches the pre-set value, Stage 2 charge will start.

STAGE 2: BOOST

When the battery voltage reaches the boost voltage, the controller will perform constant voltage charging. This is no longer MPPT charging, and the charging current will gradually decrease with time.

STAGE 3: FLOAT

Float charge is conducted following the boost charge stage. The controller will reduce the charge current to a small amount in order to prevent self-discharge of the battery and keep it fully charged. If the load exceeds this small current the battery voltage will start to decrease until it reaches the recharge voltage. When the battery voltage falls below the recharge voltage, the controller will switch back to bulk charging.

STAGE 4: EQUALIZE



Warning: Risk of explosion!

Equalizing vented lead-acid battery may generate explosive gases. So, the battery compartment must be well ventilated.



Caution: Damage of device!

Equalization can increase the battery voltage to levels that may damage sensitive DC loads. It is necessary to verify that the allowable input voltage of all system loads is greater than the equalizing charge set value.



Caution: Damage of device!

Over charge and excessive gas evolution may damage the battery plates and cause active substances on the battery plate to come off. Equalizing charge may cause damage if voltage is too high or time is too long. Please carefully check the specific requirements of battery used in the system.

Certain types of battery benefit from regular equalizing charge, which can stir electrolyte, balance battery voltage, and complete chemical reaction. The equalize charge increases the battery voltage above a standard voltage, causing vaporization of battery electrolyte. By default, this happens every 28 days.

Note

When the controller is not able to stabilize battery voltage due to the influence of installation environment or load, the controller will wait for 3 hours (or custom value if custom battery type used) and then automatically switch to float charge

CHARGE PARAMETERS FOR VARIOUS BATTERY TYPES

SET VOLTAGE BATTERY TYPE	GEL	SEALED	FLOODED	LITHIUM	CUSTOM
HIGH VOLTAGE DISCONNECT	16V	16V	16V	16V	9 ~ 17V
EQUALIZE VOLTAGE	—	14.6V	14.8V	—	9 ~ 17V
BOOST VOLTAGE	14.2V	14.4V	14.6V	14.4V	9 ~ 17V
FLOAT VOLTAGE	13.8V	13.8V	13.8V	—	9 ~ 17V
BOOST RETURN VOLTAGE	13.2V	13.2V	13.2V	13.2	9 ~ 17V
LOW VOLTAGE RECONNECT	12.6V	12.6V	12.6V	12.6V	9 ~ 17V
UNDER VOLTAGE WARNING	12V	12V	12V	12V	9 ~ 17V
LOW VOLTAGE DISCONNECT	11V	11V	11V	11V	9 ~ 17V
OVER-DISCHARGE DELAT TIME	5s	5s	5s	5s	1-30s



3. CONVERSION EFFICIENCY CURVE

EQUALIZE DURATION	—	2 hours	2 hours	—	0 ~ 10 HOURS
EQUALIZE INTERVAL	—	30 Days	30 Days	—	0~250DAYS (0 INDICATES EQUALIZE DISABLED)
BOOST DURATION	2 hours	2 hours	2 hours	—	1-10 HOURS

*Parameters are multiplied by 2 for 24V systems

3. CONVERSION EFFICIENCY CURVE

3.1 12V SYSTEMS

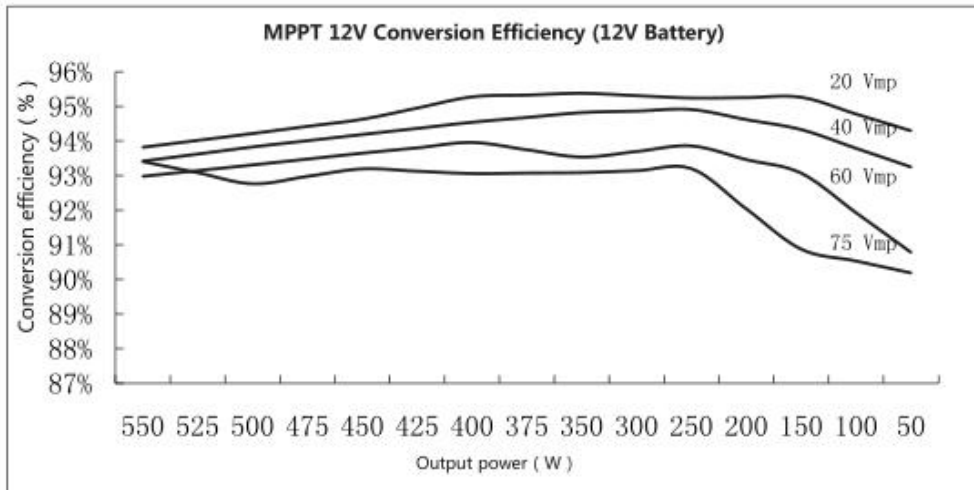

3.2 24V SYSTEMS

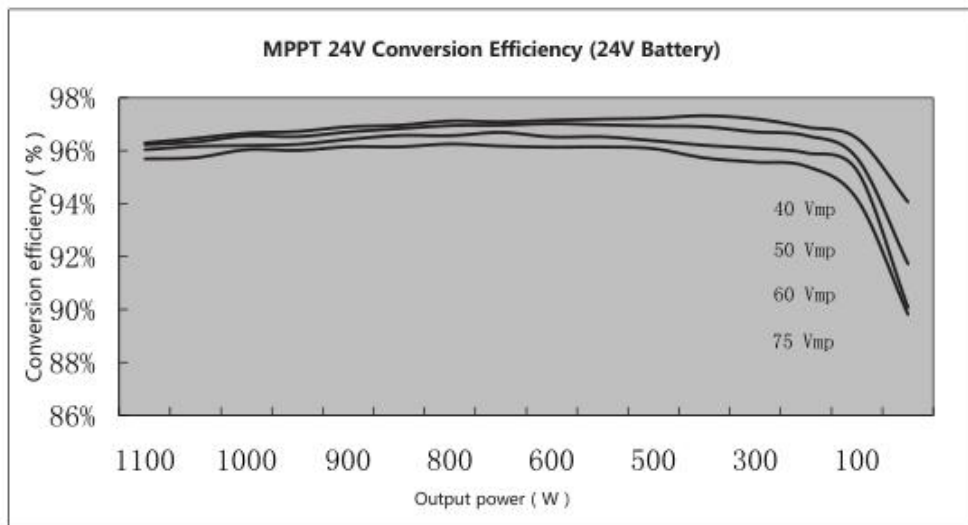

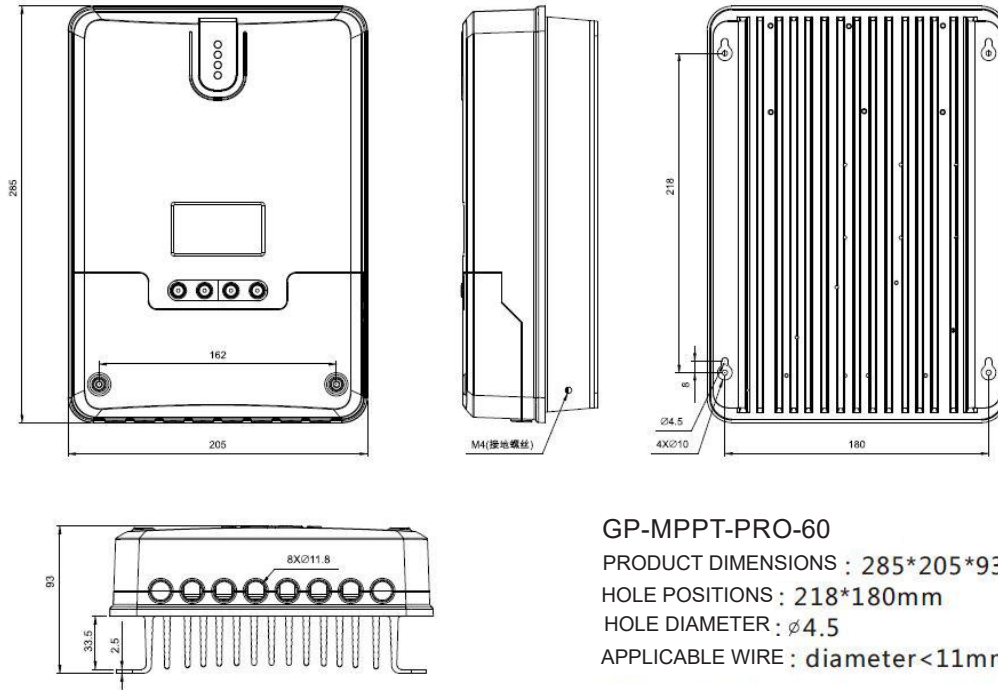

GP-MPPT-PRO-60
PRODUCT DIMENSIONS : 285*205*93mm
HOLE POSITIONS : 218*180mm
HOLE DIAMETER : $\varnothing 4.5$
APPLICABLE WIRE : diameter < 11mm

5. STATUS DISPLAY

5.1 LED INDICATION

There are four indicators on the controller.

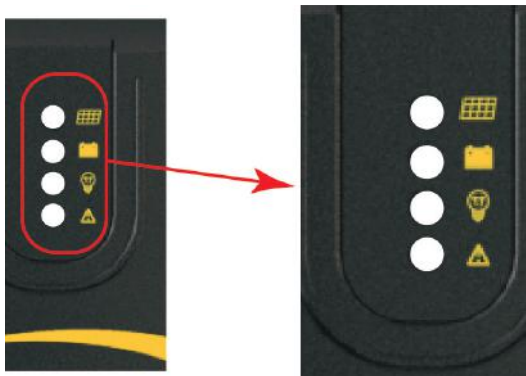

①	PV Array Indicator	Indicating the controller's current charging mode
②	BAT Indicator	Indicating the battery's current state
③	LOAD Indicator	Indicating the load's ON/OFF and state
④	ERROR Indicator	Indicating whether the controller is functioning normally

5.1.1 PV INDICATOR ①

LED PATTERN	STATUS
STEADY ON	MPPT CHARGING
SLOW FLASH (cycle of 2s with on and off each lasting for 1s)	BOOST CHARGING
SINGLE FLASH (cycle of 2s with on and off lasting respectively for 0.1s and 1.9s)	FLOAT CHARGING

QUICK FLASH <small>(cycle of 0.2s with on and off each lasting for 0.1s)</small>	EQUALIZE CHARGING
DOUBLE FLASH <small>(cycle of 2s with on for 0.1s, off for 0.1s, on again for 0.1s, and off again for 1.7s)</small>	CURRENT LIMITING
OFF	NO CHARGE

5.1.2 BATTERY INDICATOR 2

LED PATTERN	STATUS
STEADY ON	NORMAL BATTERY CHARGE
SLOW FLASH <small>(cycle of 2s with on and off each lasting for 1s)</small>	BATTERY OVER-DISCHARGED
QUICK FLASH <small>(cycle of 0.2s with on and off each lasting for 0.1s)</small>	BATTERY OVER-VOLTAGE

5.1.3 LOAD INDICATOR 3

LED PATTERN	STATUS
OFF	LOAD TURNED OFF
QUICK FLASH <small>(cycle of 0.2s with on and off each lasting for 0.1s)</small>	LOAD OVER-LOADED/SHORT-CIRCUITED
STEADY ON	LOAD FUNCTIONING NORMALLY

5.1.4 ERROR INDICATOR 4

LED PATTERN	STATUS
OFF	SYSTEM OPERATING NORMALLY
STEADY ON	SYSTEM MALFUNCTIONING

6. OPERATION AND DISPLAY

6.1.1 LCD MAIN INTERFACE

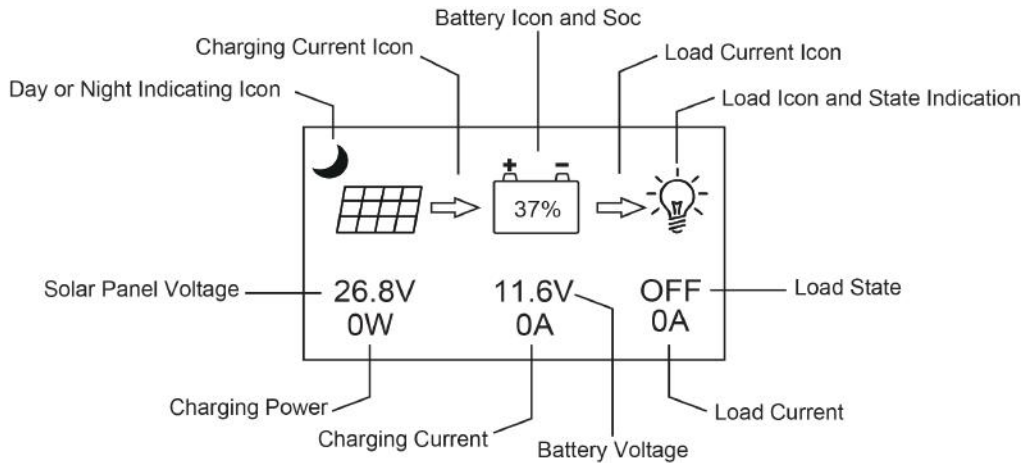

6.1.2 NAVIGATION BUTTONS

The remote features 4 buttons which, from left to right, are:



They equal to ("Up", "Down", "ESC", "Set")

Button	OPERATION	DISCRIPTION
	Tap, press and hold	1) When browsing a menu , tap the button to page up, 2) In parameter setting, tap the button to increase the value by a minimum unit; 3) Press and hold the button for quick page-up to quickly increase a value.
	Tap, press and hold	1) When browsing a menu, tap the button to page down; 2) In parameter setting, tap the button to decrease the value; 3) Press and hold the button for quick page-down to quickly increase a value.
	Tap	1) When browsing a menu, tap the button to return to the previous level, until the main menu is reached; 2) In setting mode, tapping this button can cancel the data modification in process and exit the setting mode.
	Press and hold	In any menu, press and hold the button to immediately skip to the "error code page for convenience.
	Tap	1) In a menu which contains submenus, tap the button to enter into a submenu; 2) In a menu with settable or adjustable parameters, tap the button to enter into or confirm a parameter setting.
	Press and hold	If "manual mode" is selected as the load mode, press-and-hold on the button to switch on/ off the load If it's not in the manual mode, press-and-hold will cause the display to skip to the load mode setting interface as a reminder. (Note: if no load is connected to the controller, this function and related load parameters will become inoperative.)

6.1.3 ICON DESCRIPTION

ICON	STATE	DISCRIPTION	COMMENTS
	Steady on	Nighttime	Related to charging
	Steady on	Daytime	
	Steady on	A dynamic arrow indicates charging is in process, while a static one indicates otherwise	
	0 to 100%	Current battery capacity	Related to battery
	0% in slow flashing	Battery over-discharged	
	100% in quick flashing	Battery over-voltage	
	Steady on	A bulb shown as left and a dynamic arrow indicate the load is switched on.	Related to load
	Steady on	A bulb shown as left and a static arrow indicate the load is switched off.	
	Quick flashing	Overload or short-circuit protection	

6.1.4 MENU BLOCK DIAGRAM

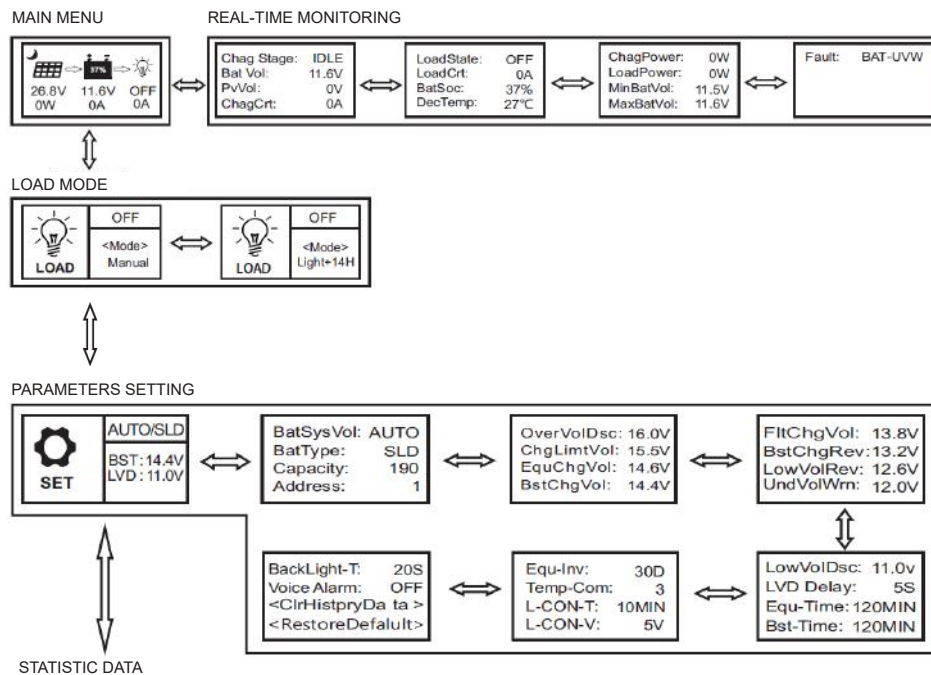

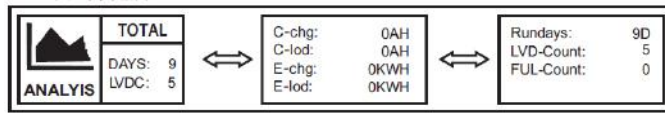

HISTORICAL DATA OF THE CURRENT DAY

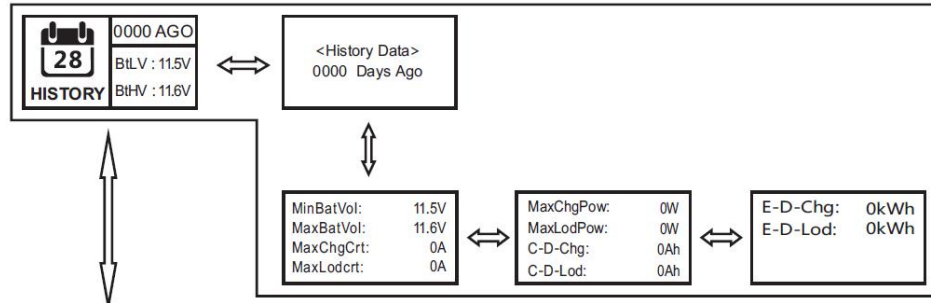

DEVICE INFORMATION



BLUETOOTH® CONNECTION STATE

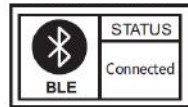

(This menu is available only to the display units with the optional Bluetooth® function)

Refer to “Navigation Buttons” for operations including entering into and exiting each of the above menus, related parameters setting, etc.

6.1.5 REAL-TIME MONITORING

(This menu is contained in and supplementary to information of the main menu)

In the MAIN MENU, tap to enter into this menu; continue to tap , to switch between menus; or tap to return to the MAIN MENU. (Refer to 9.4 USAGE OF NAVIGATION BUTTONS for operation)

PAGE	PROJECT OR PARAMETER	DECRPTION
1	ChagState: IDLE	Charging state indications: IDLE, no charging MPPT, MPPT charging EQU, equalizing charging BST, boost charging FLT, floating charging LIMIT, current-limited charging
	BatVol: 11.6V	Battery voltage
	PvVol: 0V	Solar panel voltage
	ChagCr t: 0A	Charging current

2	LoadState: OFF	Load in "ON" or "OFF" state
	LoadCrt: 0A	Load current
	BatSoc: 100%	Remaining battery capacity
	DevTemp: 27°C	Controller temperature
3	ChagPower: 0W	Charging power
	LoadPower: 0W	Discharging power
	MinBatVol: 12.5V	The current day's min. battery voltage
	MaxBatVol: 13.0V	The current day's max. battery voltage
4	Fault: NULL	Controller error codes: BAT-LDV, over-discharge BAT-OVD, over-voltage BAT-UVW, under-voltage warning L-SHTCRT, load short-circuit L-OVRCRT, load over-current DEV-OVT, internal over-temperature BAT-OVT, battery over-temperature P-OVP, solar panel overpower P-SHTCRT, solar panel short-circuit P-OC-OVD, solar panel over-voltage P-MP-OVD, solar panel working over-voltage P-REVERSE, solar panel reverse-connection

6.1.6 SYSTEM PARAMETER SETTINGS

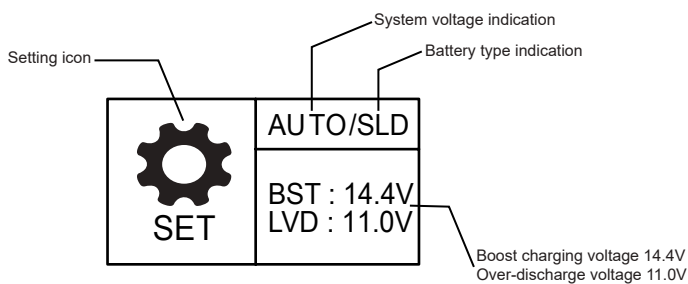

The Parameters Setting page will have a brief summary of the parameters already set in this menu:

- AUTO: the battery voltage is the automatic recognition system
- SLD: battery type is sealed lead acid battery;
- BST: charging voltage is 14.4V*n
- LVD: over-discharge voltage is 11.0V*n
- Tap to enter into the following submenus.

PAGE	ITEM TO SET	DISPLAYED ITEM/ PARAMETER	PARAMETER AND SETTING RANGE
1	Battery system voltage	BatSysVol	12V, 12V system 24V, 24V system 36V, 36V system 48V, 48V system AUTO, auto recognition
	Battery type	BatType	SLD, sealed lead-acid battery FLD, open lead-acid battery GEL, gel battery LI, lithium battery USE, user defined
	Nominal battery capacity	Capacity	0 to 9999
	Device address	Address	1 to 60
2	Over-voltage threshold	OverVolDsc	9.0 to 17.0V
	Charging limit voltage	ChgLimtVol	9.0 to 17.0V
	Equalizing charging voltage	EquChgVol	9.0 to 17.0V
	Boost charging voltage	BstChgVol	9.0 to 17.0V
3	Floating charging voltage	FltChgVol	9.0 to 17.0V
	Boost charging recovery voltage	BstChgRev	9.0 to 17.0V
	Over-discharge recovery voltage	LowVolRev	9.0 to 17.0V
	Under-voltage warning level	UndVolWrn	9.0 to 17.0V
4	Over-discharge voltage	LowVolDsc	9.0 to 17.0V
	Over-discharge time delay	LVD Delay	0 to 60s
	Equalizing charging time	Equ-Time	0 to 300MIN
	Boost charging time	Bst-Time	0 to 300MIN
5	Equalizing charging interval	Equ-Inv	0 to 30D (days)
	Temperature compensation	Temp-Com	-(3 to 5) mV/ °C/ 2V
	Light control time	L-CON-T	0 to 60MIN
	Light control voltage	L-CON-V	5 to 11V
6	LCD screen backlight time	BackLight-T	1 to 600s (ON indicates the screen is lit constantly)
	Fault voice alarm	Voice Alarm	ON, voice alarm enabled OFF, voice alarm disabled
	Clear historical data	<ClrHistoryData>	Select YES for execution
	Reset to factory settings	<FoactoryDefault>	Select YES for execution

Note

1) In this manual, "n" assigned with a value of 1, 2, 3 or 4 denotes a battery system of 12V, 24V, 36V or 48V accordingly.

Note

2) Before setting parameters, first refer to the User Manual of the corresponding controller. As some parameters are not settable, operation of setting these parameters on the display unit will be deemed as invalid or impossible by the controller.

6.1.7 CONTROLLER CHARGING AND DISCHARGING RELATED PARAMETER SETTINGS

- All voltage values are to be set based on 12V system settings. For example, for a 24V system, if the over-discharge voltage is to be set to 22.0V, as $n=24/12=2$, the value needed in line with 12V system settings is $22.0V/2=11.0V$, therefore the over-discharge voltage needs to be set to 11.0V.
- Tap \downarrow , \uparrow to select the item to be set; then tap \rightarrow , and the parameter or sign will flash; continue to tap \downarrow , \uparrow to adjust the value, and tap \rightarrow again to confirm the setting. (For the setting ranges of related parameters, refer to Parameter settings list)
- For parameters on the current menu, those highlighted are settable, while those underlined are not

6.1.8 LCD SCREEN BACKLIGHT TIME SETTING

CHARACTERS DISPLAYED	DESCRIPTION
BackLight-T: ON	The LCD screen is lit constantly
BackLight-T: 20S	The setting range of LCD screen backlight time is 1 to 600s

Enter into the setting menu, tap \downarrow , \uparrow to move to **BackLight-T: 20S**, tap \rightarrow to enter into the setting mode, and tap \downarrow , \uparrow to modify the value within the setting range (**ON indicates the screen will be constantly lit, and the range of backlight time is "1-600" S**)

Tap \rightarrow to confirm the modification, or tap \leftarrow to cancel the modification.

6.1.9 CONTROLLER ABNORMALITY VOICE ALARM - ON/OFF SETTING

BUZZER STATE	ALARM TYPE
No Alarm	System running well
Alarm sound: every 1 min	Battery over-discharge, Load short circuit/overload, controller or battery over-temperature
Alarm sound: every 15 sec	Battery under-voltage
Alarm sound: Persistent	Battery over-voltage, solar panel reverse connection, solar panel over voltage

CHARACTER DISPLAYED	DESCRIPTION
Voice alarm: ON	Voice alarm enabled
Voice alarm: OFF	Voice alarm disabled



Enter into the setting manual, tap \downarrow , \uparrow to move to **Voice Alarm: XXX**, tap \rightarrow to enter into the parameter setting mode, and again use \downarrow , \uparrow to switch between **ON** and **OFF**. Tap \rightarrow to confirm the modification, or tap \leftarrow to cancel the modification.

Factory settings disable the voice alarm function by default (the aforementioned faults will not trigger alarms with the voice alarm disabled).

6.1.10 CLEAR HISTORICAL DATA AND RESET TO FACTORY SETTINGS





ClrHistoryData → YES, clear historical data

RestoreDefault → YES, reset to factory settings

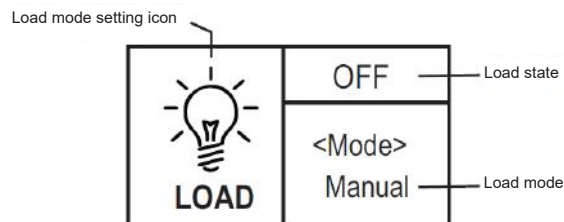
Tap  to enter into the submenu, and a NO and YES selection menu will pop up. Use ,  to select YES, then tap  again, and YES will flash a few times. If NO is selected, tap  to directly return to the previous level.

6.1.11 LOAD MODES



- If the characters displayed on top of <Mode> are ON, it indicates that the load is switched on, and OFF indicates the load is switched off.
- Tap  to enter into the load setting mode, and right below the <Mode>, the mode characters or digits will begin to flash. Use ,  to select any one from the load modes listed in the following table, and tap  again to complete the load mode setting.
- Press and hold  in any menu but not the setting mode: if the current load mode is “manual mode”, pressing and holding the button will switch on/ off the load; if the current load mode is not “manual mode”, pressing and holding the button will cause the display to skip to the load mode setting interface and a reminder will pop up telling the user in this mode, pressing and holding the button will not switch on/ off the load. For parameters on the current menu, those highlighted are settable, while those underlined are not.

LOAD MODE	MODE CHARACTERS	DESCRIPTIONS
Sole light control mode	Light+On	The solar panel voltage is lower than the light control on voltage, and after a preset time delay , the controller will switch on the load; The solar panel voltage is higher than the light control off voltage, and after a preset time delay , the controller will switch off the load.
Light control + time control mode 1 to 14H	Light+01H Light+14H	The solar panel voltage is lower than the light control on voltage, and after a time delay, the controller will switch on the load. From this point on, the load will work for a preset period of time (1 to 14 hours) before being switched off.
Manual mode	Manual	In this mode, whether it's day or night, users can press and hold the “OK” button to switch on or off the load; this mode is often used in some special occasions or during commissioning.
Debugging mode	Debug	As long as the solar panel voltage is lower than the light control on voltage, the controller will immediately switch on the load; As soon as the solar panel voltage gets higher than the light control off voltage, the controller will immediately switch off the load. This mode is usually used during system installation and commissioning.
Normal on mode	Normal On	This mode is suitable for applications requiring 24-hour operation, and after being switched on, the load keeps outputting in this mode.

6.1.12 STATISTIC DATA

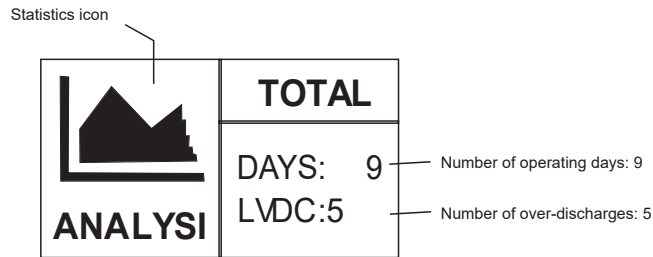

Including total charging amp-hrs, total discharging amp-hrs, total power consumption, numbers of operating days, over-charges and full-charges.

PAGE	DISPLAYED ITEM/PARAMETER	DESCRIPTION
1	C-D-Chg: 0AH	The charging amp-hrs
	C-D-Lod: 0AH	Total discharging amp-hrs
	E-Chg: 0KWH	Total power generation
	E-Lod: 0KWH	Total power consumption
2	Rundays: 10D	Total number of operating days
	LVD-Count 0	Total number of over-charges
	Full-count 0	Total number of full-charges

6.1.13 HISTORICAL DATA OF THE CURRENT DAY

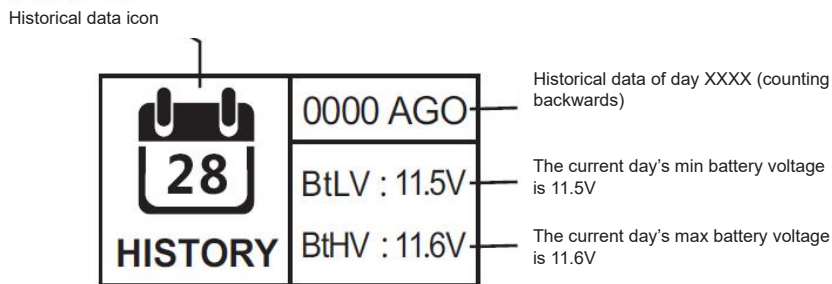

(**Historical data** including: the current day's min. battery voltage, the current day's max. battery voltage, the current day's max. charging current, the current day's max. discharging current, the current day's max. charging power, the current day's max. discharging power, the current day's charging amp-hrs, the current day's discharging amp-hrs, the current day's total power generation and the current day's total power consumption)

PAGE	DISPLAYED ITEM/ PARAMETER	DESCRIPTION
1	<History Data> xxxx Days Ago	XXXX: select the historical data of day xxxx (counting backwards) 0000: the current day 0001: yesterday 0002: the day before yesterday
1	MinBatVol: 11.5V	The selected day's min. battery voltage
	MaxBatVol: 11.6V	The selected day's max. battery voltage
	MaxChgVol: 0A	The selected day's max. charging current
	MaxLodVol: 0A	The selected day's max. discharging current
2	MaxChgPow: 0W	The selected day's max. charging power
	MaxLodPow: 0W	The selected day's max. discharging power
	C-D-Chg: 0AH	The selected day's total charging amp-hrs
	C-D-Lod: 0AH	The selected day's total discharging amp-hrs
3	E-D-Chg: 0kWh	The selected day's total power generation
	E-D-Lod: 0kWh	The selected day's total power consumption

6.1.14 DEVICE INFORMATION

Device Information icon

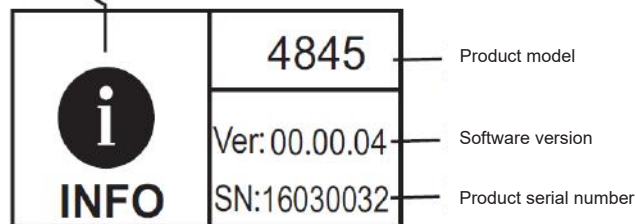

ITEM	DESCRIPTION
Model: 4845	Controller model
HW-ver: 00.02.07	Hardware version
SW-ver: 00.00.04	Software version
Serial: 160300032	Controller serial number

You are now ready to begin installing your new solar controller, please ensure you have read all safety precautions in section 1.1 of this manual and then proceed with the following instructions.

7.1 TOOLS AND MATERIALS NEEDED

- Screwdriver.
- Multimeter

Note

If the solar controller was purchased with a Go Power! RV Solar Power Kit the UV resistant wire is included. For instructions regarding the Go Power! RV Solar Power Kit installation, please refer to the installation guide provided with the kit

7.2 INSTALLATION AND WIRING

STEP 1: CHOOSE AN INSTALLATION LOCATION

The GP-MPPT-PRO controllers are designed to be mounted vertically in a battery box with sufficient ventilation and should be as close to the battery as possible. Adequate space above and below the controller is vitally important to ensure proper natural convection for heat dissipation as shown below. Avoid installing the controller in a place with direct sunlight, high temperature, and/or water.



STEP 2: MARK THE MOUNTING POSITION ACCORDING TO THE MOUNTING DIMENSIONS OF THE CONTROLLER.

First, place the installation guide plate at a proper position and use a marking pen to mark the mounting points. Drill 4 mounting holes of the appropriate size at the 4 marks. Fix screws into the upper two mounting holes.

STEP 3: FASTEN THE CONTR OLLER

Align fixed holes of the controller with the two pre-fixed screws and hang the controller up. Then fix the lower two screws.

STEP 4: WIRING

Wiring and installation must comply with national and local electrical code requirements.

The wire from the solar array most commonly enters the RV through the fridge vent on the roof or by using the Go Power! Cable Entry Plate (sold separately) that allows installers to run wires through any part of the roof. PV connections should connect directly to the controller.

Positive and negative battery connections must connect directly from the controller to the batteries and positive and negative PV connections must connect directly from the solar array to the controller. Wires that are as short as possible and adequately sized (see table below) should always be used. Use of a positive and/or negative distribution bus that is properly sized is recommended between the controller and battery – do not stack wires on the battery terminals.



Warning: Danger, Electric shock hazards! We strongly recommend connect a fuse or circuit breaker to the PV array and battery terminals to prevent electric shock hazards during wiring or error operation, and make sure that fuse or circuit breaker is disconnected before wiring.

Model	PV maximum input current	Max. wire diameter at PV end (mm ² /AWG)	Rated charge current	Battery wire diameter (mm ² /AWG)
GP-MPPT-PRO-60	60	11/4	60A	11/4

We recommend a wiring sequence shown below.

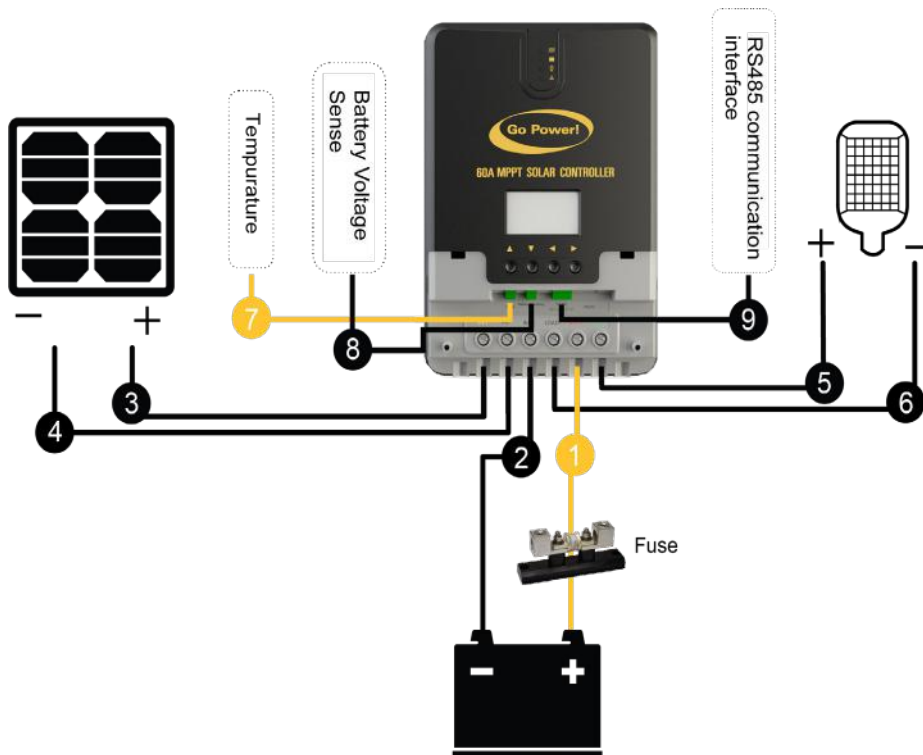

Note

- 1) Note that the battery fuse shall be installed as close as possible to the battery terminal. The recommended distance is considered to be not more than 150mm.
- 2) The battery temperature is 25°C (fixed value) when the controller is not connected to a remote temperature sensor.



BATTERY VOLTAGE SENSE

The voltage measured at the battery input on the GP-MPPT-PRO-60 may differ slightly from the voltage measured directly at the battery bank terminals. This is especially true when the GP_MPPT-PRO-60 is bulk charging and is due to connection and cable resistance. The Battery Voltage Sense input enables the GP_MPPT-PRO to measure the battery terminal voltage precisely with small gauge wires that carry very little current and, as a result, have no voltage drop.

A battery voltage sense connection is not required to operate your GP_MPPT-PRO-60 and it will charge your battery bank accurately without this input. However, it is recommended that these voltage sense wires are connected to ensure that the voltage and diagnostic displays are very accurate. The voltage sense wires are not included in the box with the GP-MPPT-PRO-60. Wires with the following requirements can be used and should be cut to length as required to connect the battery to the voltage sense input on the GP-MPPT-PRO-60. The wires may be routed with the power conductors.

- 16 to 24 AWG (1.0 to 0.25 mm²)
- Twisted pair cable is recommended but not required
- UL rated 300 Volt
- Maximum length for each wire is 50 ft (15.24 m)

7.3 WIRING FOR PARALLEL OPERATION

Multiples of the GP-MPPT-PRO-60 can be wired in parallel to charge the same battery bank for increased charging current. When wired in parallel the controllers will coordinate to ensure they work together to provide as much power to the battery bank as possible.

Note

Only the battery output can be wired in parallel, the solar input of each controller must be individually wired to separate solar arrays.

Note

While configured for parallel operation, the built-in display, remote display and Bluetooth dongle only relay information for the individual solar controller that they are connected to. This means each controller will need a separate remote display or Bluetooth dongle. To get a complete picture of the total power going to the battery bank the charge current displayed for each controller must be added together

7.3.1 WIRING DIAGRAM

1. CONTROLLER

The controller can be used separately or in parallel operation and, when used in parallel, it needs to connect to the RS485 communication cable.

2. SOLAR PANEL

The solar panel should be connected independently with the controller, and the power of each circuit should not exceed the rated power of the controller.

3. BATTERY BANK

A battery bank consist of several batteries possessing specific voltages and capacities.

4. RS232 COMMUNICATION INTERFACE

The RS232 connects to the PC or Bluetooth™ and can process information from the controller offering real-time monitoring and other functionality.

5. RS485 COMMUNICATION INTERFACE

The controller must be connected to the cable in order to achieve a parallel operation.

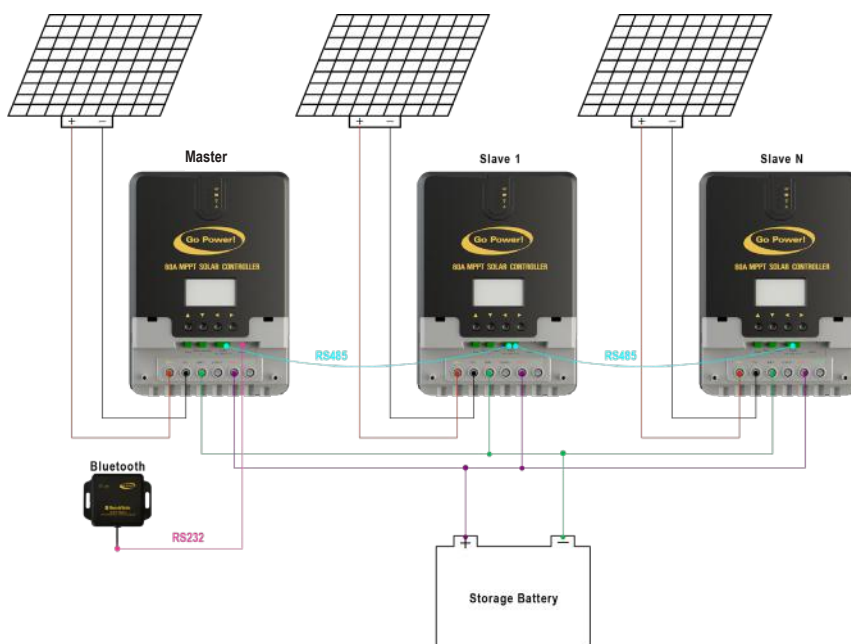

7.3.2 ORDER OF CONNECTION

1. Connect the battery first, then the solar panel and finally the load. Follow the “+” and “-” pole connection mode.
2. Connect the **Master controller** first, then connect to the next **Slave** controller followed by the battery, solar panel and lastly, the controller according to the ID.

7.3.3 INTERFACE DEFINITION

RS485 INTERFACE

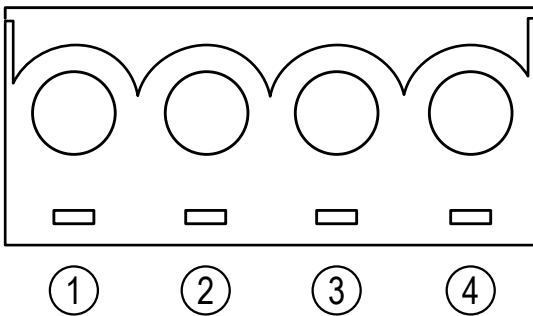

NO.	DEFINITION	PARALLEL OPERATION
①	12V	
②	GND	Black
③	D-	Yellow
④	D+	Red

RS485 WIRING DIAGRAM (PARALLEL OPERATION)

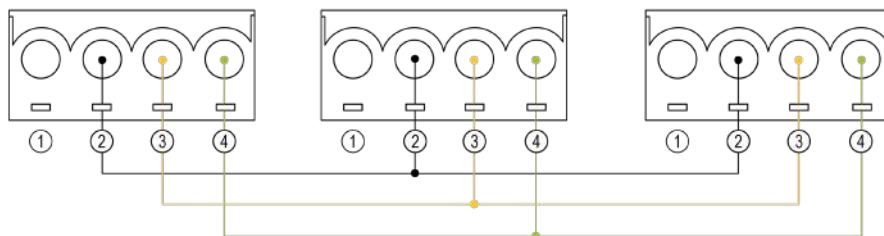

7.3.4 PARAMETER SETTING

IN-SET MENU

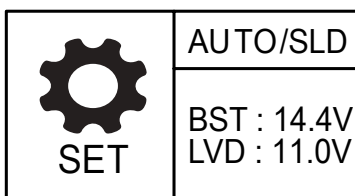

1. **ADDRESS:** the ID of the **MASTER** must be minimal, followed by the number from the machine to the large set.

For example, the **MASTER** ID is set to number 1, the **SLAVE** ID of the second controller is set to number 2 and the **SLAVE** ID of a third one would be set to 3.

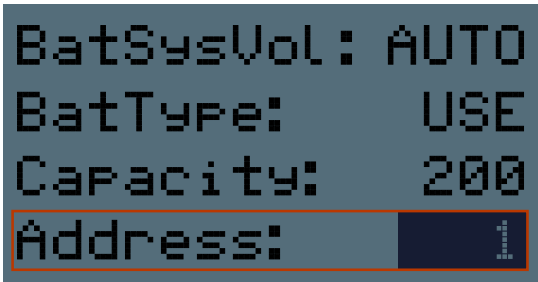

MASTER ID

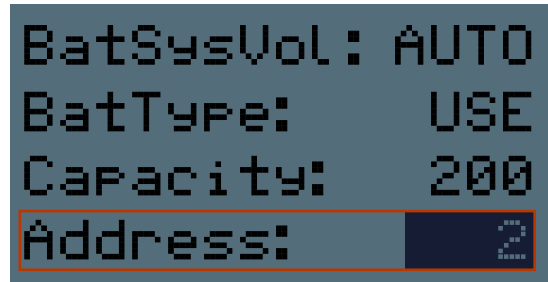

SLAVE ID

Note

If the HOST fails, the minimum address ID from the controller will automatically change to the HOST and take over the rest from the controller, without causing the whole system to fail.

2. 485: parallel CHG (parallel mode)

Note

All controllers must be set to PARALLEL CHG mode.



COMMUNICATION MODE



PARALLEL MODE

Note

The 485 interface of ML4860 can be used to communicate with external communication, or it can be used for Parallel operation. If it is used in Parallel operation, the function of 485 must be adjusted to Parallel CHG mode.

3. The left image is the interface of the **HOST** controller when it is used. The right is the interface from the machine when it is used. Charging and discharging instructions are different.

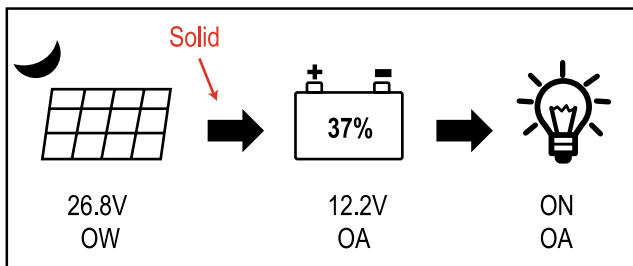

MASTER

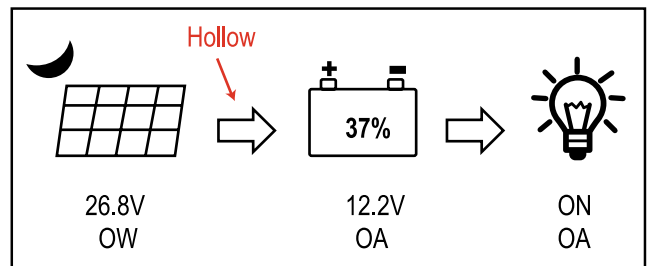

SLAVE

8.1 BLUETOOTH™ ADAPTER PRODUCT INTRODUCTION

The GP-MPPT-PRO-BT-1 makes the GP-MPPT-PRO-60 solar controllers and Bluetooth ready to work seamlessly with the Go Power! Connect mobile app giving you the ability to wirelessly monitor you controller's parameters setting and data view.



GP-MPPT-PRO-BT-1

8.2 MAIN FEATURES

1. Convenient wireless monitoring of your solar controller
2. Supports the Go Power! Connect mobile app allowing for simple set-up and plug & play functionality
3. The use of high performance, low power consumption of the bluetooth special chip
4. Adopt Bluetooth 4.0 and BLE technology, has the characteristics of rapid communication and strong anti-jamming capability
5. Does not contain external power supply, powered directly by the communication port
6. Communication distance of up to 15 meters

The MPPT-PRO-60 is only able to accomodate the Bluetooth® Dongle *OR* the remote. It will not be able to accomodate both.

8.3 LED STATUS

INDICATOR LIGHT	STATE	EXPLANATION
LINK INDICATOR LIGHT	BLINK	CONNECTED
	OFF	IDLE STATE

8.4 APPLICABLE TYPE

APPLY SERIES	COMMUNICATION	CONTROLLER PORT
All of our controllers employ TTL level communication and a PH2.0 port	TTL	PH2.0

8.5 PRODUCT FEATURES



8.6 PRODUCT DIMENSIONS

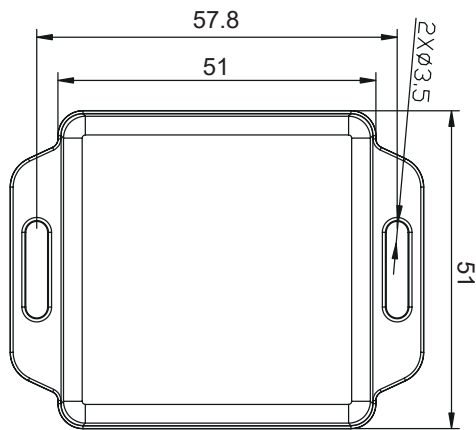

GP-MPPT-PRO-BT-1
FRONT VIEW

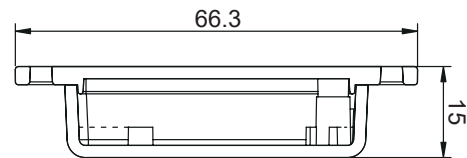

GP-MPPT-PRO-BT-1
SIDE VIEW

External Dimensions: 66.3 X 51 X 15 mm
Fixed holes dia: ϕ 3.5

8.7 SYSTEM WIRING DIAGRAM



Note: Cable using the standard Ethernet cable (parallel line) connect.

8.8 SPECIFICATIONS

TYPE	GP-MPPT-PRO-BT-1
Input voltage	5 - 12V
Stand-by power consumption	0.04W
Run power consumption	0.05W
Communication distance	≤ 15m
Serial port baud rate	Fixed baud rate 9600bps
Communication methods	RS232
Interface type	RJ12
Connecting line	Standard network cable (parallel cable)
Size	66 X 51 X 15.5mm
Installation dimension	57.5 X 15mm
Fixed holes dia	ø3.5mm
Operating temperature	-20°C - 75°C
Level of protection	IP67
Net weight	120g

9.1 PRODUCT FEATURES

1. LCD graphical main menu enables easy view of complete operating data of the system in real time.
2. Simple button design combine aesthetic appearance and easy operation.
3. Directly powered by controller, external power supply is not needed.

Note

The MPPT-PRO-60 is only able to accomodate the Bluetooth® Dongle *OR* the remote. It will not be able to accomodate both.

9.2 APPEARANCE

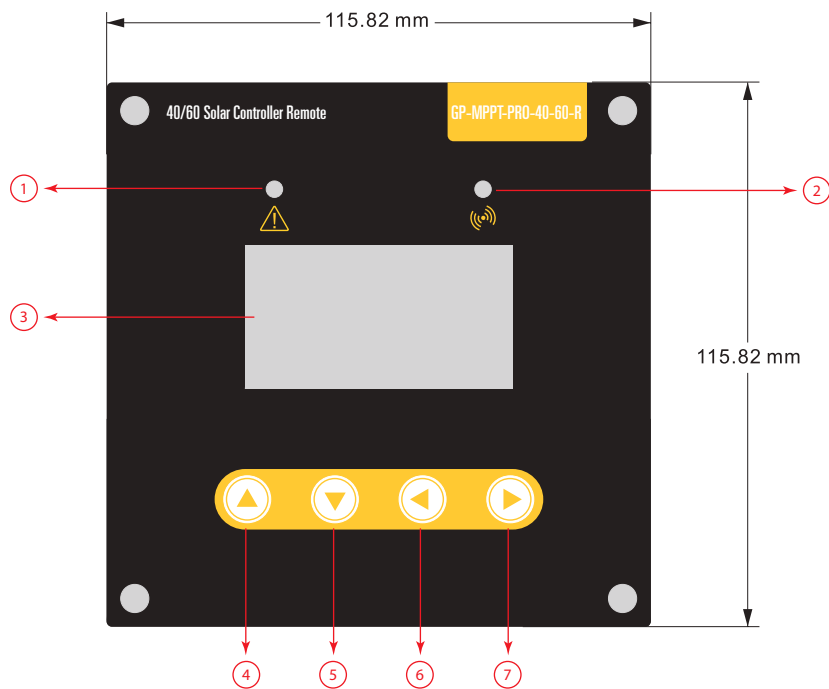

NO.	FUNCTIONS
1	Communication Fault Indicator
2	Communication Connection Indicator
3	LCD Screen
4	Up Button
5	Down Button
6	Escape Button
7	Set Button

9.3 INSTALLATION DIMENSIONS

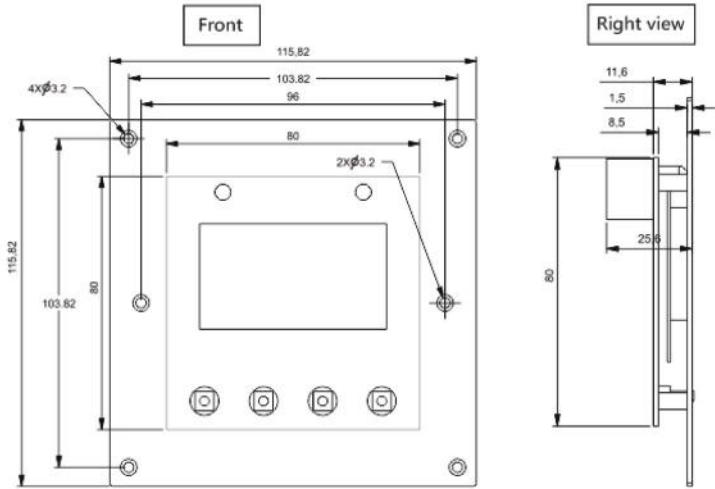

Product dimensions: 96*103.82*103.82mm
 Installation dimensions: ø3.5mm

9.4 COMMON PROBLEMS AND SOLUTIONS

SYMPTOMS.	SOLUTION
The screen won't light up after being turned on	Check whether the communication cable has the right core order, the connection is properly done and the controller functions normally, etc.
The screen is stuck at "Connecting..."	
The fault indicator flashes quickly	An error has occurred with the controller. Check the error code, pinpoint the cause, analyze and solve issue.
The communication indicator flashes slowly.	Communication between the display unit and controller is abnormal. Check the connection cable and controller.

9.5 FAULT INDICATION AND COMMUNICATION INDICATION

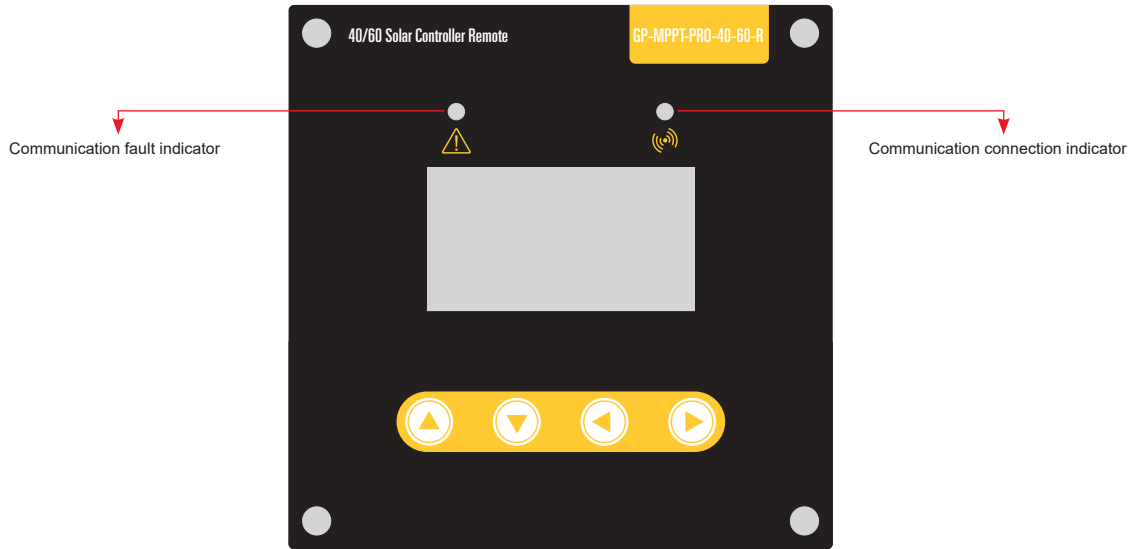

MENU LEVEL	STATE	DESCRIPTION
System fault indicator	Steady off	The controller system is normal
	Quick flashing	Abnormality occurs to the controller system (Please check the error code).
Communication connection indicator	Steady off	Communication connection between the LCD display unit and controller is normal.
	Slow flashing	Communication connection between the LCD display unit and controller abnormality

In order to maintain the best long-term performance for the controller, conduct inspections twice a year using the following points:

- Make sure the airflow around the controller is unobstructed and remove any dirt or debris from the heat sink.
- Check if the insulation layers of all exposed wires are damaged due to sun exposure, friction with other objects nearby, dry rot, destruction of insects or rodents. If so, it may be necessary to repair or replace the wire.
- Verify if indicators are consistent with the device operations. Please note to take corrective action for any malfunctions or error indications.
- Check all wiring terminals for corrosion, insulation damage, signs of high temperature or burning/discoloration. Tighten terminal screws.
- Check for dirt, insects and corrosion and clean as required.



Warning: Danger, electric shock hazards! Make sure that all power supplies to the controller have been disconnected before check or operation as above

10.1 ERRORS AND WARNINGS

No.	Error Display	Description	LED Indication
1	E0	No error	ERROR indicator off
2	E1	Battery over-discharge	BAT indicator flashing slowly ERROR indicator steady on
3	E2	System over-voltage	BAT indicator flashing quickly ERROR indicator steady on
4	E3	Battery under-voltage warning	ERROR indicator steady on
5	E4	Load short circuit	LOAD indicator flashing quickly ERROR indicator steady on
6	E5	Load overloaded	LOAD indicator flashing quickly ERROR indicator steady on
7	E6	Over-temperature inside controller	ERROR indicator steady on
8	E7	Photovoltaic component overloaded	ERROR indicator steady on
9	E8	Photovoltaic component over-voltage	ERROR indicator steady on
10	E9	Photovoltaic component reversely connected	ERROR indicator steady on



11. WARRANTY

1. Go Power warrants the GP-MPPT-40 for a period of five (5) years from the date of shipment from its factory. This warranty is valid against defects in materials and workmanship for the five (5) year warranty period. It is not valid against defects resulting from, but not limited to:
 - Misuse and/or abuse, neglect, or accident
 - Exceeding the unit's design limits
 - Improper installation, including, but not limited to, improper environmental protection and improper hook-up
 - Acts of God, including lightning, floods, earthquakes, fire, and high winds
 - Damage in handling, including damage encountered during shipment
2. This warranty shall be considered void if the warranted product is in any way opened or altered. The warranty will be void if any eyelet, rivets, or other fasteners used to seal the unit are removed or altered, or if the unit's serial number is in any way removed, altered, replaced, defaced, or rendered illegible.

11.1 REPAIR AND RETURN INFORMATION

Visit www.gpelectric.com to read the "frequently asked questions" section of our website to troubleshoot the problem. If the trouble persists:

1. Call your Go Power!® Technical Support team (1-866-247-6527).
2. Return defective product to place of purchase

© 2020 Go Power!

Worldwide Technical Support and Product Information gpelectric.com

Go Power!

201-710 Redbrick Street Victoria, BC, V8T 5J3

Tel: 1.866.247.6527

82804_MAN_GP-MPPT-PRO-60_RevA

