

57 mm, 75 mm Carbo® Ratchamatic® Blocks

USA – Tel: (+01) 262-691-3320 • Web: www.harken.com • Email: harken@harken.com
 Italy – Tel: (+39) 031.3523511 • Web: www.harken.it • Email: techservice@harken.it

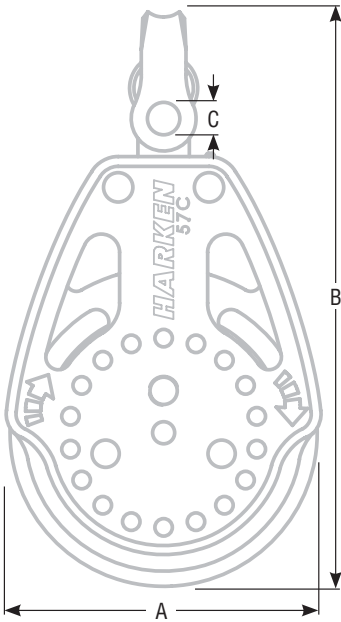

Strictly follow all instructions to avoid an accident, damage to your vessel, personal injury or death. See www.harken.com for additional safety information.



IMPORTANT: See Inspection and maintenance at end of manual.

Features

Glass-filled nylon sideplates: load-carrying curved bearing races.

Machined hardkote-anodized aluminum sheaves: strength and corrosion resistance.

Fast trim: Free-running ball bearings.

Hand-hold and release loaded line: Faceted aluminum sheave grips line securely. Ratchets provide mechanical advantage.

Multi-faceted Power3 sheaves: very aggressive holding power.

Load-sensing ratchet block: rolls freely in both directions under low loads and automatically engages ratchet as loads increase.

Ratchet engagement adjustable: adjustable to ratchet at higher/lower load to match sailor's strength and sailing style.

Cam arm locking plates: Allows cam arms to be locked in more than five positions for fair leads.

Cheek: Line-shedding, small mounting footprint and drain holes. Mounts on port or starboard.

Common uses: Main/jib/spinnaker sheets on dinghies and sportboats; control lines on boats of all sizes.

Ratchamatic® Blocks

Do not apply a load greater than the maximum working load (MWL) of the Carbo® Ratchamatic® blocks listed below.

Part No.	Description	A		B		C		Max line Ø		Maximum working load		Breaking load	
		in	mm	in	mm	in	mm	in	mm	lb	kg	lb	kg
57 mm													
2625	Single	2 1/4	57	4 1/16	103	3/16	5	3/8	10	500	227	2000	907
2165	Single/swivel/Power3/ 1.5x grip	2 1/4	57	4 1/16	103	3/16	5	3/8	10	500	227	2000	907
2168	Single/swivel/Power3/ 2x grip	2 1/4	57	4 1/16	103	3/16	5	3/8	10	500	227	2000	907
2626	Single/becket	2 1/4	57	4 15/16	125	3/16	5	3/8	10	500	227	2000	907
2627	Single/150 Cam-Matic®	2 1/4	57	4 1/16	103	3/16	5	3/8	10	300	136	750	340
2628	Single/150 Cam-Matic/becket	2 1/4	57	4 15/16	125	3/16	5	3/8	10	600	272	1500	680
2633	Cheek**	2 1/4	57	3 1/4	83	—	—	3/8	10	500	227	2000	907
2629	Triple/150 Cam-Matic	2 1/4	57	4 1/16	103	1/4	6	3/8	10	1500	680	3750	1700
2630	Triple/150 Cam-Matic/becket	2 1/4	57	4 15/16	125	1/4	6	3/8	10	1800	816	4500	2041
2632	Triple/150 Cam-Matic/40 mm block/becket	2 1/4	57	6 1/8	156	1/4	6	3/8	10	1800	816	4500	2041
2634	Double	2 1/4	57	4 9/16	116	1/4	6	3/8	10	750	340	1875	851
75 mm													
2174	Single/swivel/Power3/ 1.5x grip	2 15/16	75	5 3/8	137	1/4	6	7/16	12	750	341	3000	1361
2176	Single/swivel/Power3/ 2x grip	2 15/16	75	5 3/8	137	1/4	6	7/16	12	750	341	3000	1361
2680	Single	2 15/16	75	5 3/8	137	1/4	6	7/16	12	750	341	3000	1361
2681	Single/becket	2 15/16	75	6 1/2	165	1/4	6	7/16	12	750	341	3000	1361
2682	Cheek**	2 15/16	75	4 1/16	103	—	—	7/16	12	750	341	3000	1361
2683	Single/150 Cam-Matic	2 15/16	75	5 1/16	138	1/4	6	7/16	12	300	136	750	340
2684	Single/150 Cam-Matic/becket	2 15/16	75	6 1/2	165	1/4	6	7/16	12	600	272	1500	680
2685	Triple/150 Cam-Matic	2 15/16	75	6 3/16	137	5/16	8	7/16	12	1500	680	3750	1700
2686	Triple/150 Cam-Matic/becket†	2 15/16	75	6 1/2	165	3/16	8	7/16	12	1800	816	4500	2041
2687	Triple/150 Cam-Matic/57 mm block/becket	2 15/16	75	6 1/2	165	5/16	8	7/16	12	1800	816	4500	2041

**Includes RH fasteners and mounting pad.

3-Way Cam-Lock—All Ratchamatic® Singles



1. Cam lever up. Block locks in front or side position.
2. Cam lever down. Block turns freely.



1

2

Using Ratchamatic® Block

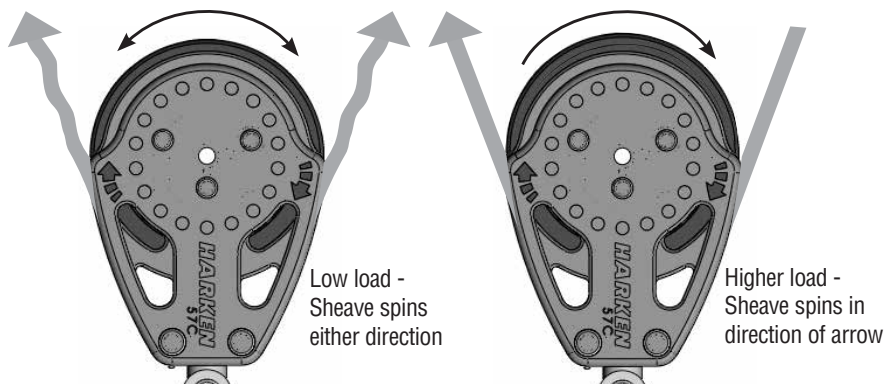

Ratchamatic® blocks spin freely in both directions under low load. At higher load, ratchet engages, and sheave facets provide holding power. As the load decreases, the ratchet shifts back into light air mode and free spins. Unloaded main and jib sheets run out freely during mark roundings and asymmetrical spinnakers run free during jibes.

Ratchet direction: Arrow on side of block shows direction that sheave will spin in ratchet mode. Refer to arrow when reeving block or mounting cheek block.

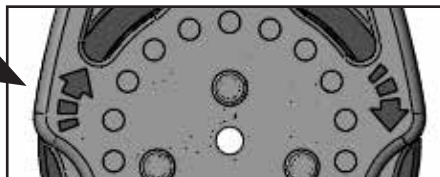

Adjusting Ratchamatic®



Remove becket to access ratchet adjustment hole.

INSERT
2.5 mm hex wrench
(included)

ALIGN HOLE in sheave
with bottom of block



Holding Power

Ratchamatic blocks allow hand holding loaded sheets. The eight-sided faceted sheave grips loaded sheets yet allows a line to be eased instantly with control. They allow the crew to hand hold main, jib, and spinnaker sheets with only a fraction of the effort that a regular block requires.

Holding power varies according to sheave size and type.

57 mm Ratchamatic blocks with eight-sided faceted sheaves can provide up to 10:1 holding power.

57 mm Power3 Ratchamatic blocks with added facets offer increased holding power. See chart below.

75 mm Ratchamatic blocks with eight-sided faceted sheaves can provide up to 15:1 holding power.

Holding power ratios are determined using a 180° wrap angle and can vary according to line type, and line condition.

Power3 Ratchamatic® Blocks - Holding Power

Power3 Ratchamatic® blocks offer three options of faceted holding power to best take advantage of the day's wind and wave conditions.

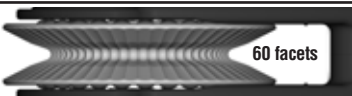
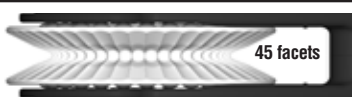
57/75 mm block no.	Sheave color	Holding power 57 / 75 *	Sheave image and facet count**
2625 - 57 mm 2680 - 75 mm	Black	10:1 15:1	 8 facets
Example: Block holds 45 kg (100 lb) load with 4.5 kg (10 lb) of effort			
2165 - 57 mm 2174 - 75 mm	Titanium (tan)	15:1 22:1	 60 facets
Example: Block holds 67.5 kg (150 lb) load with 4.5 kg (10 lb) of effort			
2168 - 57 mm 2176 - 75 mm	Silver	20:1 30:1	 45 facets
Example: Block holds 90 kg (200 lb) load with 4.5 kg (10 lb) of effort.			

*Holding power ratios are determined using a 180° wrap angle and can vary according to line type, and line condition. Depending on line composition and cover texture, the more aggressive sheave facets can increase line wear.

**The 2770 sheave has fewer facets than the 2168 and gains more holding power by having more prominent ridges.

2633 Cheek Block

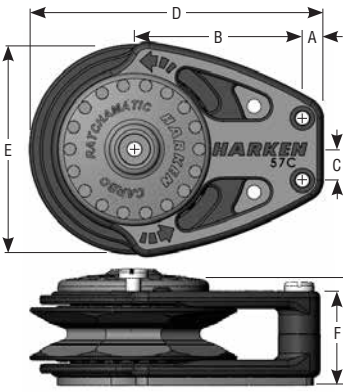

Remove circular mounting cap. Position block so ratchet turns in desired direction (see drawing below). Flip block to change direction. Use chart below or use block as a template and mark holes using center punch. Check marks with block before drilling. Remove block and drill holes using drill shown below in chart. Bevel top of deck holes using a small knife to allow sealant to mass. Place gasket under block. Through-bolt block using recommended stainless steel fasteners, washers and locknuts. Do not overtighten center screw or ratchet will bind. Test block after mounting to make sure ratchet engages smoothly and rotation direction is correct.

Ratchamatic® cheek blocks include metric roundhead screws, washers and nuts. See chart.

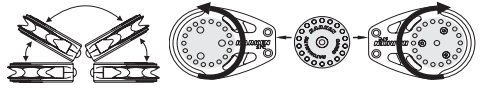

Block part no.	Size	Drill size		Supplied mm size fastener and length
		mm	in	
2633	57 mm	4.25	1 ¹ / ₆₄	M4 x 60 mm

*Fastener length: Add deck thickness and overhang for nut and washer.

Block size	Part No.	A		B		C		D		E		F		G	
		in	mm	in	mm	in	mm	in	mm	in	mm	in	mm	in	mm
57 mm	2633	7 ¹ / ₃₂	6	1 ³ / ₄	44.5	2 ¹ / ₆₄	8.3	3 ¹ / ₄	83	2 ¹ / ₄	57	1	25	1 ³ / ₃₂	29

2682 Cheek Block

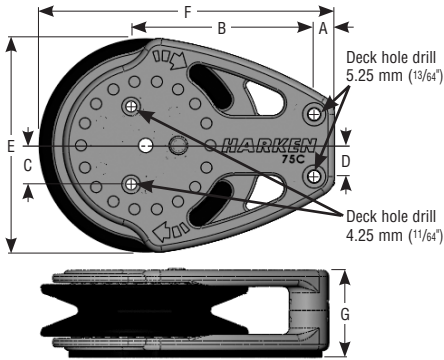

Position block so ratchet turns in desired direction. Refer to arrow for sheave direction in ratchet mode. Flip block to change direction. Use chart below or use block as a template. Mark holes using centerpunch. Check marks with block before drilling. Remove block. **Important—holes are different diameter.** Use two drill sizes for deck holes. See chart and diagram. Bevel top of deck holes using a small knife to allow sealant to mass. Place gasket under block. Through-bolt block using recommended stainless steel fasteners, washers and lock nuts.

Ratchamatic cheek blocks include metric roundhead screws, washers and nuts. See chart below:

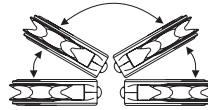

Block Part No.	Size	Drill sizes		Supplied fastener x length
		mm	in	
2682	75 mm	4.25 / 5.25	1 ¹ / ₆₄ / 1 ³ / ₆₄	M4 / M5 x 60 mm

*Fastener length: Add deck thickness and overhang for nut and washer.

Block Size	Part No.	A		B		C		D		E		F		G	
		in	mm	in	mm	in	mm	in	mm	in	mm	in	mm	in	mm
75 mm	2682	9 ¹ / ₃₂	7	2 ¹ / ₃₂	64	1 ⁷ / ₃₂	13.5	2 ⁷ / ₆₄	11	2 ¹⁵ / ₁₆	75	4 ¹ / ₁₆	103	1 ¹ / ₄	31

3-Way U-Lock—2629 / 2630 / 2632 / 2634 / 2685 / 2686 / 2687

The 3-Way U-Lock on doubles and triples allows a change of headpost direction from front-to-side or allows the block to swivel. To change headpost direction, remove shackle, turn post, install shackle. Remove U-Lock to allow block to swivel.

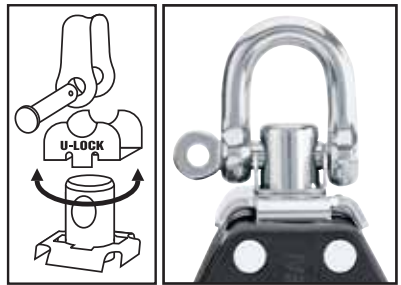

Adjust Cam Angle (Single/Triple)

1. Loosen cam arm locking plate screw and pull outward to disengage.
2. Rotate cam arm to desired position.
3. Press locking plate in and tighten screw.

Do not overtighten screws or sheave will bind.

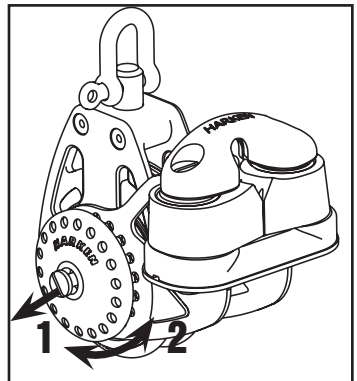

Reverse Cam Cleat (Single Only)

1. Remove screws from cam.
2. Assemble as shown. Note: use plastic plate on cam as shown at right.
3. Tighten screws. **Do not overtighten screws or cams will bind.**

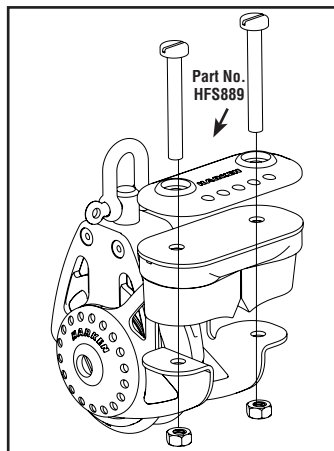

Reeving Multi-Purchase Systems

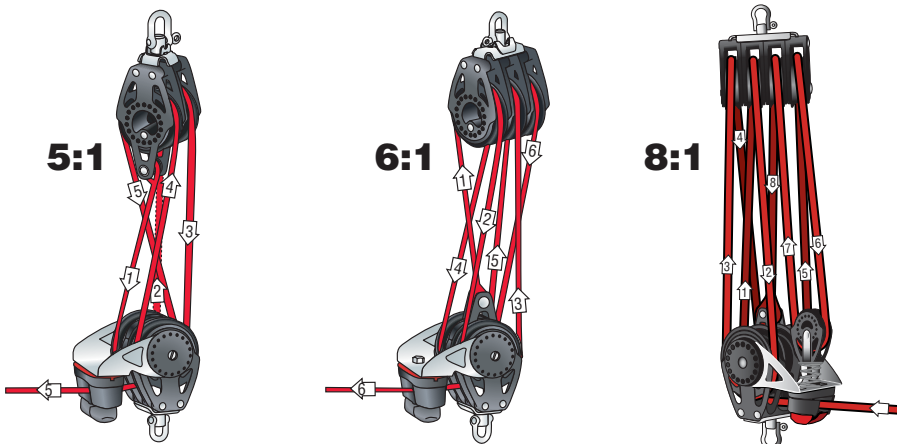

Right-angle reeving deadend on becket

For larger, printable diagrams, please see: www.harken.com.

Inspect Block and Shackle Before You Sail



WARNING! Failure to inspect and replace damaged metal parts and/or worn or frayed line can cause block or system to break causing an accident, damage to your vessel, personal injury or death. See www.harken.com for additional safety information.

Frequently inspect shackles and shackle posts for signs of corrosion, cracks, or elongation. When replacing shackles, use the correct Harken parts to maintain proper strength. Replace line as necessary, taking into consideration the maximum size recommendation.

Maintenance

Flush block and attachments frequently with detergent and fresh water. Clean bearings by flushing areas shown while rotating sheave.



If block has cam cleat, flush balls in cam cleats while rotating pawls.

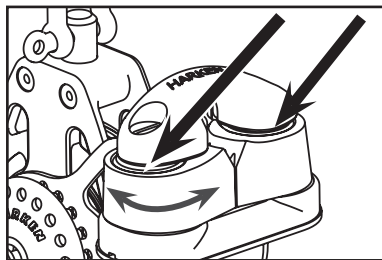

Warranty

For additional safety, maintenance, and warranty information see www.harken.com or the Harken catalog.