

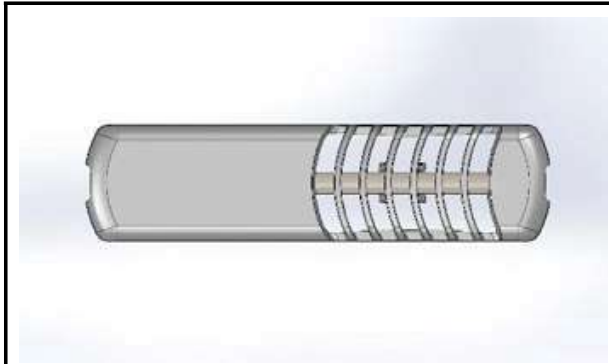

## INTELLIGENT TEMPERATURE CONTROL



# ISOTHERM Digital Display



**Fig.1**

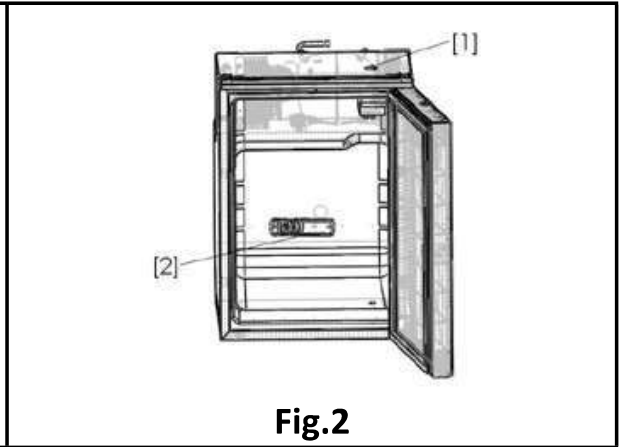

**Fig.2**

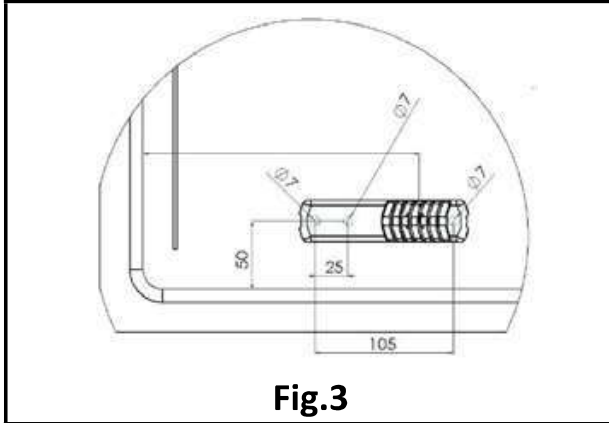

**Fig.3**

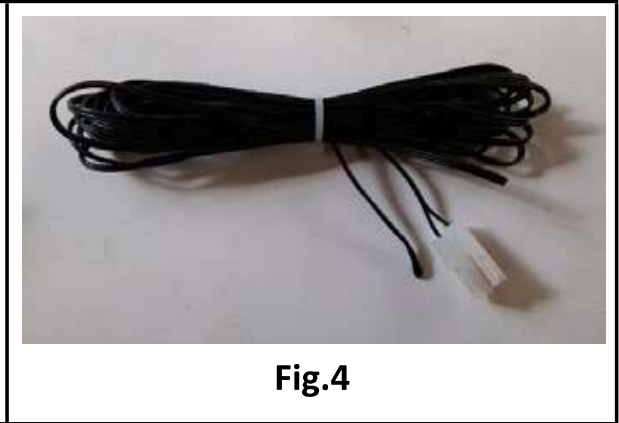

**Fig.4**

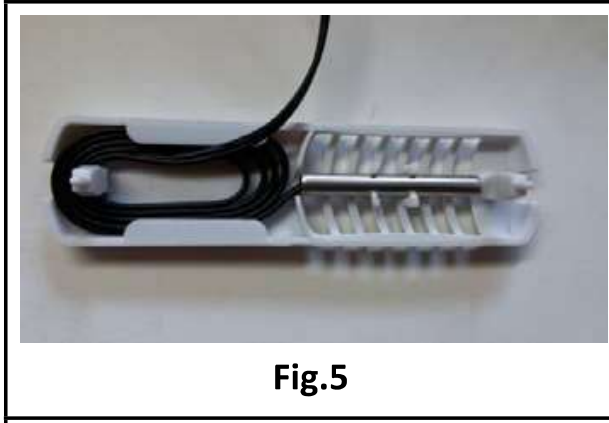

**Fig.5**

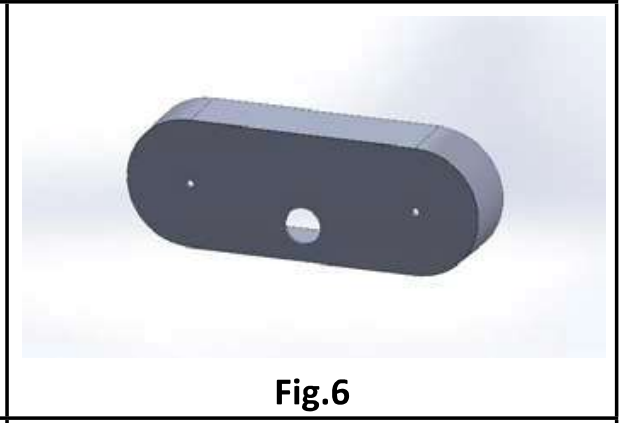

**Fig.6**

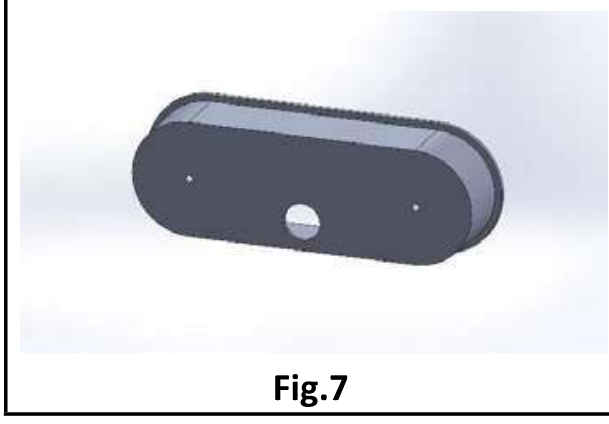

**Fig.7**



**Fig.8**

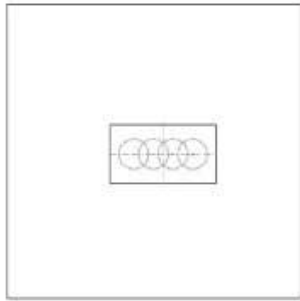

**Fig.9**

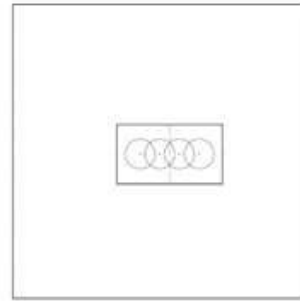

**Fig.10**

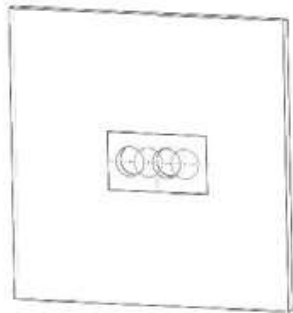

**Fig.11**

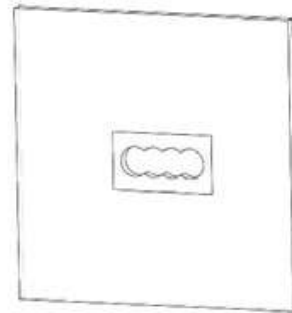

**Fig.12**

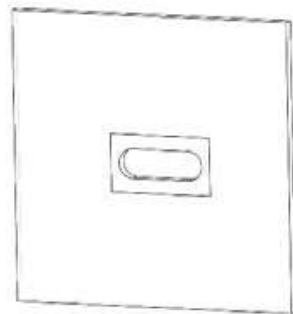

**Fig.13**

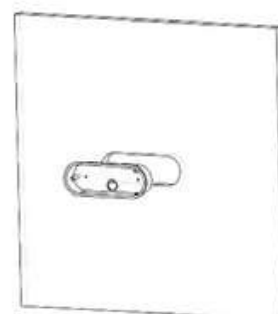

**Fig.14**

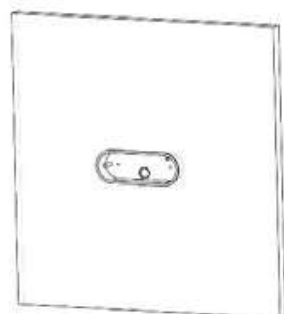

**Fig.15**



**Fig.16**

# ISOTHERM Digital Display



**Fig.17**



**Fig.18**

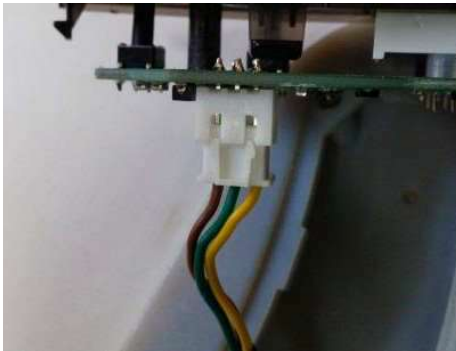

**Fig.19**



**Fig.20**

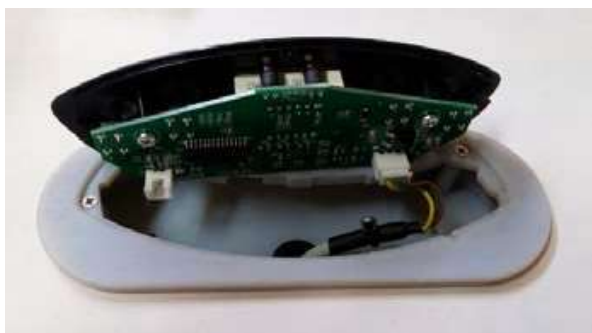

**Fig.21**



**Fig.22**

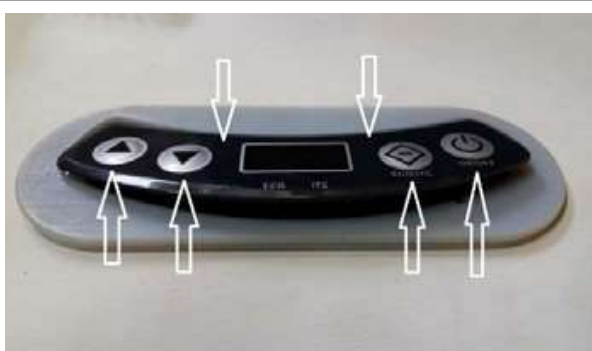

**Fig.23**



**Fig.24**



**Fig.25**



**Fig.26**

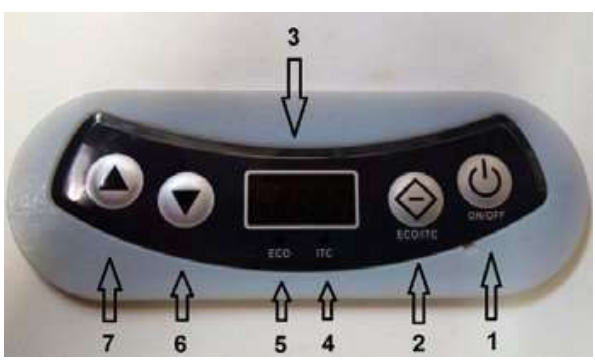

**Fig.27**



**Fig.28**



**Fig.29**

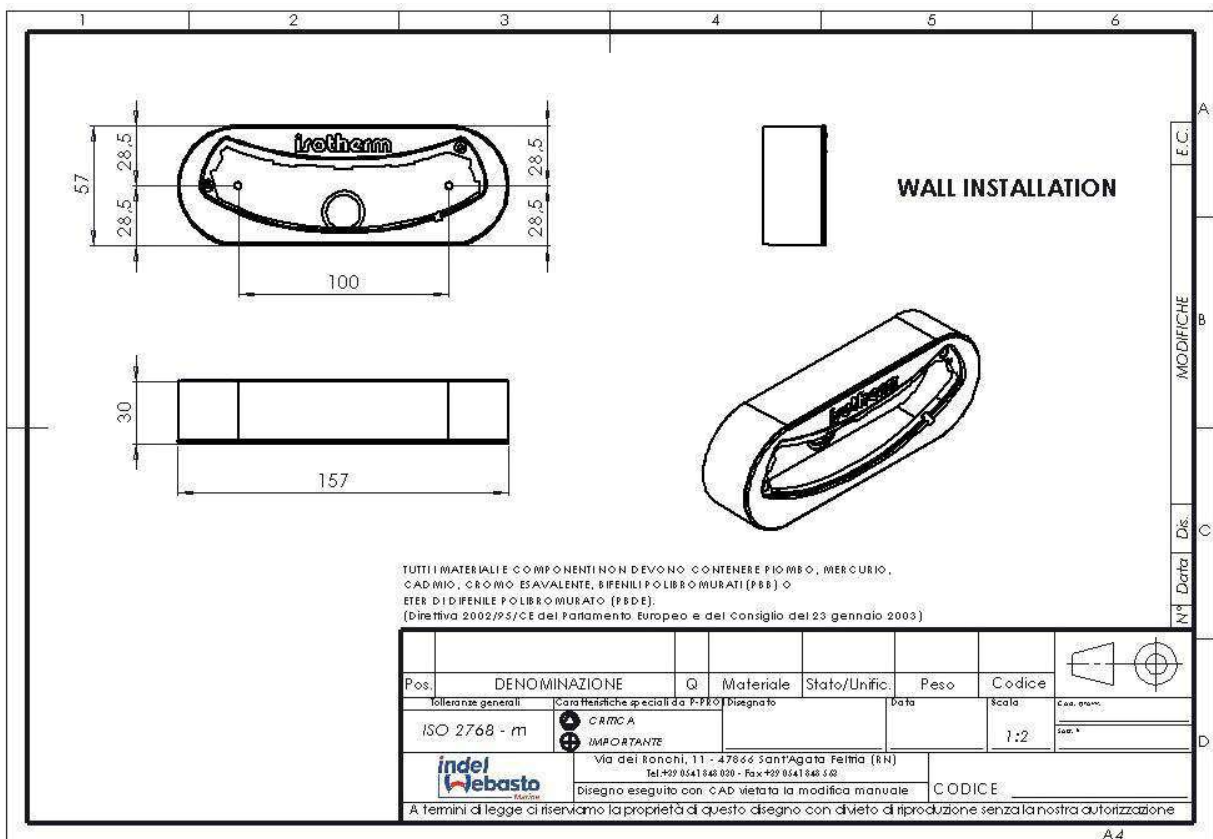
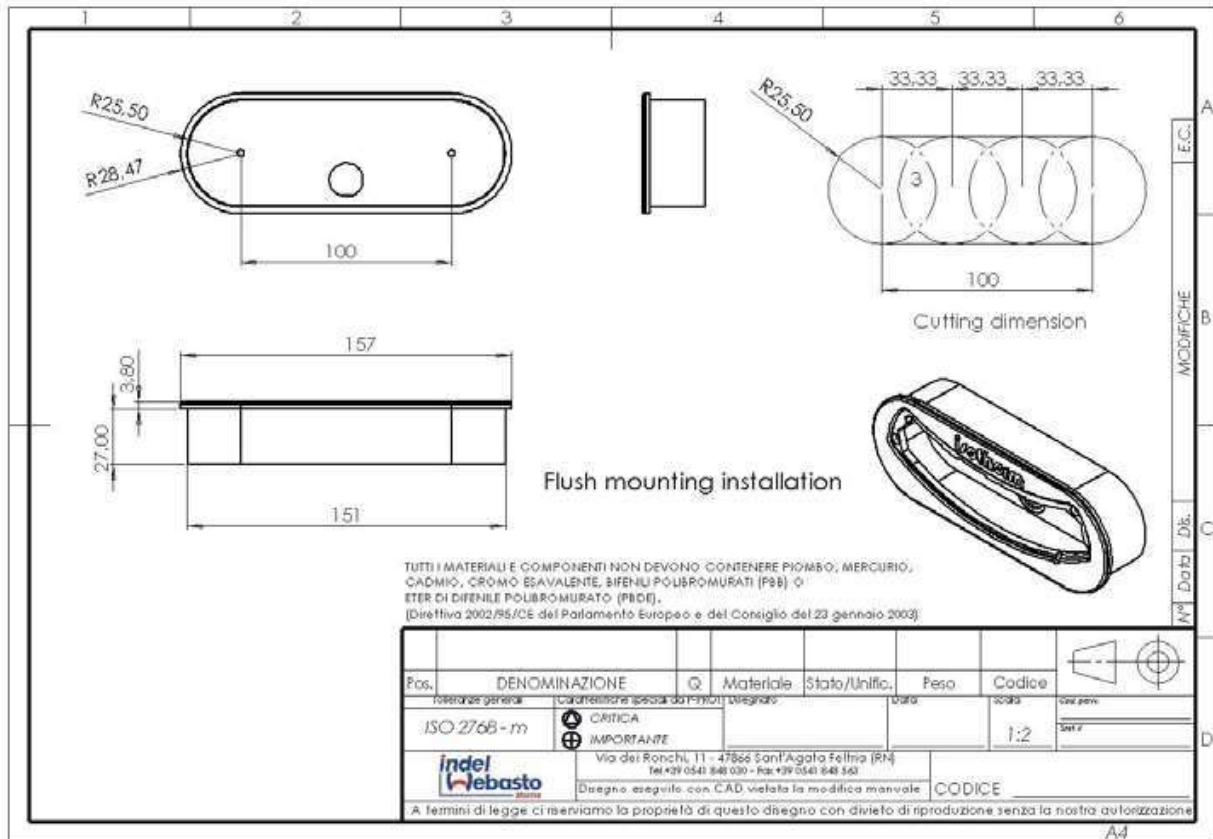

**Fig.30**



**Fig.31**

# ISOTHERM Digital Display



# ISOTHERM Digital Display

## COMPATIBILITY

- The device is compatible only with control units code IWM SEG00002DA Secop version 101N0212 and SEG00030GA Secop version 101N0510.  
Make sure that your device is equipped with this specific control unit before installation.

## Instruction and Use





This manual contains warnings to signal dangers to the user or particular behaviour to comply with; these warnings are indicated as follows:





**WARNING!**



Do not start the product before reading this instruction manual.

<p>Obligation to read instructions The presence of this symbol mandates reading of instructions before putting the unit into operation.</p>	
<p>Obligation to disconnect The presence of this symbol mandates immediate disconnection of the unit from the mains in case of failures.</p>	
<p>Obligation to wear gloves The presence of this symbol mandates each operator wear suitable protective gloves.</p>	
<p>Obligation to wear shoes The presence of this symbol mandates each operator wear shoes designed to decrease the risk of injury.</p>	
<p>General hazard The presence of this symbol mandates special attention by the operator.</p>	

<p><b>Shock Hazard</b> The presence of this symbol tells personnel involved that the described operation may present a risk of electric shock.</p>	
<p><b>High intensity light hazard</b> The presence of this symbol indicates that you must take special care with the high intensity bright lights, risk to eyesight.</p>	



**WARNING!** This manual must be kept for future reference. We recommend that users:

- Store this manual in an accessible location protected from moisture and heat and protected from the direct rays of the sun.
- Use the manual in such a way as to avoid damaging it or any part of its content.
- Do not remove, alter or tear on any part of the manual.

Despite the care and thoroughness with which this manual has been prepared, Indel Webasto Marine Srl cannot guarantee that the information within covers every possible event associated with installation of the product. Contact our technicians immediately in the event of uncertainty. In the event of selling or transferring the unit to another person, this manual and related documents should be delivered intact to the new user.

## Environment

This product complies with the Directive 2002/96/EC regarding waste electrical and electronic equipment (WEEE).

The product's proper disposal is essential to preventing negative consequences for the environment and human health.



The symbol  on the product, the packaging and/or the accompanying documentation indicates that the product should not be disposed of as household waste. The product must be taken to an authorized collection centre for the recycling of electrical and electronic equipment. The product must be disposed of in compliance with the current local environmental regulations regarding waste



## ISOTHERM Digital Display

---

disposal. 

### Safety Standards



WARNING! Indel Webasto Marine Srl disclaims all liability for any malfunction or damage to persons or property due to improper use of the machine or with materials with different characteristics than those described in this manual.

Improper use or use of the product not in line with the information contained in this manual cannot result in claims against the manufacturer and/or supplier.



WARNING! The refrigerator is only suitable for the preservation and/or storage of food items. The food items must be stored in their original packing or else in suitable containers. Do not consume expired food products as such behaviour could result in food poisoning.



WARNING! If medicines are to be stored in the refrigerator, check that the unit has a cooling capacity that will meet the requirements of the respective medicines.



WARNING! The only purpose and function of the product when used as a freezer is to maintain already frozen food completely frozen.

The refrigerator will not freeze non-frozen or partially frozen food products. If a non-frozen or partially frozen food product is stored in the freezer, this is considered improper use and can cause possible unintended thawing of food which may lead to problems related to safety, illness or injury if swallowed.

The preservation of non-frozen or partially frozen food in the freezer can also affect the quality of other frozen food products stored in the freezer.

Exposure to temperatures above the temperature of the climatic class range for which the freezer was built, power supply interruptions and/or frequent opening of the freezer can influence the effectiveness of the refrigerator and the quality of the contents of the freezer.

The user should always check food quality before ingesting.

**WARNING!**

Disconnect the unit from the mains power supply immediately in the event of any malfunction. Never touch any damaged or non-insulated electrical cables while the electrical power supply is enabled. This observation is particularly true when the unit is connected to 115V or 230V mains voltage.

If the power cable is damaged, it must be replaced. Contact qualified personnel or the Service Centre.



**WARNING!** Do not store inside the unit or in the vicinity of its electrical parts: flammable substance-based spray cans, explosive materials, electrical equipment, live animals.

Spray cans containing flammable substances may have leakage of these gases which, in contact with electrical parts, can ignite or cause explosions.

Keep any drinks with high alcohol content tightly closed and upright.

Avoid flames or sparks inside the unit.

Do not use electrical equipment inside the refrigerator.



**WARNING!** The unit can be used by children under 8 years of age and by people with reduced physical, sensory or mental capabilities, or lack of experience or knowledge, provided they are supervised or after they have received instructions on safe use of and understanding of the dangers inherent in it.

Children should not play with the unit. Cleaning and maintenance meant to be performed by the user and must not be performed by unsupervised children.



**WARNING!** Do not use plugs and switches if you have wet hands or feet.

For more information regarding the disposal, recycling and reuse of the product, please contact your local authorities, your local waste collection service or the retailer/distributor from whom the product was purchased.

# ISOTHERM Digital Display

---

## INTRODUCTION

- The Digital Display is able to clearly and simply display, control and regulate temperature within a refrigerated compartment from the outside. By means of an electronic sensor, the electronic control unit detects the actual air temperature, supply voltage and any errors inside the refrigerator. Software processes the data, combining them with the user selected settings directly on the display, and defines compressor operation.

The system is equipped with:

- Soft Start (always present) for effective, safe start-up of the compressor
  - Fast Cooling (in ITC mode) to lower the temperature as quickly as possible
  - Over Cooling (to be set) to accumulate cold when there is a surplus of energy, for example with the motor on, to use it when power is only coming from the battery
- 
- **Components making up the kit:**
    - o Instructions manual
    - o Digital display
    - o Digital display support frame
    - o Container for wall installation
    - o Container for flush mounting installation
    - o Temperature sensor with cable
    - o Grille and temperature sensor support
    - o Display connection cable
    - o 2 M2.5 screws
    - o 2 self-tapping screws
    - o Rubber cable gland

## Installation Warnings



WARNING!



In order to guarantee the unit's safe functionality, follow the indications included with in these instructions when installing and connecting the unit.



WARNING! Always use PPE



(Personal Protective

Equipment) during product handling and installation.



WARNING! Any changes made to the product without the knowledge of the manufacturer will be the sole responsibility of those carrying out said changes. Changes made without the permission of Indel Webasto Marine Srl will void all warranties and may void the declaration of conformity to applicable directives.



WARNING! Check for any visible damage on the refrigerator's mechanical and electrical components prior to use.



WARNING! Do not damage refrigerant circuit pipes. Coolant sprays can damage eyesight.



WARNING! In the event of damage to the unit itself, notify the supplier immediately before performing the connections.



WARNING! If the power cable is damaged, it must be replaced by the manufacturer, an authorized Service Centre or a qualified technician.



WARNING! Install the refrigerator in a dry place that's sheltered against water spray. The unit's electrical components must NOT be exposed to rainfall and/or

# ISOTHERM Digital Display

---

sprays of water.



WARNING! Install the refrigerator away from gas or LPG cylinders.



WARNING! The product must be installed in an area accessible for any maintenance. The housing space of live parts and of the condensing unit/compressor must only be opened voluntarily and not directly accessible.



WARNING! If there is a battery charger, it must be connected to the battery and never directly to the refrigerator.



WARNING! In case of power connection from AC mains, to avoid the risk of serious personal injury, ensure that it is equipped with cut-off devices (switches) which permit total disconnection of the unit current and protective devices which automatically intervene in the event of malfunction.



WARNING! Never touch any damaged or non-insulated electrical cables while the electrical power supply is enabled. This observation is particularly true when the unit is connected to 115Volt or 230Volt mains voltage.

## Installation

- o **Check that the Secop compressor control unit is type 101N0212 (BD35F and BD50F) or 101N0510 (BD35F and BD50F).**
- o **The unit is equipped with all the components necessary for its assembly, which is easy. Flush mounting installation requires the use of a  $\varnothing$  51mm [2.00in] hole cutter that is suitable for drilling the material into which the digital display will be installed.**
- o IWM is not responsible for incorrect installation or improper use.
- o We recommend installing the device in a location that is not accessible by untrained personnel.

- **Positioning the grille and sensor connection:**
  - o Identify where you will place the cooled compartment sensor holder grille (as per subsequent instructions), verifying that any holes for fixing the grille or for cable passage will not damage the cooling system, electrical system or other that can affect correct system operation or the safety of property and/or persons.
  - o The grille in **Fig. 01** is necessary for supporting and positioning the sensor on a wall for air temperature detection inside the refrigerated compartment.
  - o The grille should be placed as far away as possible from the evaporator (cooling plate) and about 50mm [1.97in] from the bottom, if possible in a central position on the wall, see ex. **Fig. 02** and **Fig. 03**. Hole positions for sensor holder grille installation are already indicated on Cruise Elegance models for maximum product efficiency.
  - o To fasten the grille, make two 7mm [0.275in] diam. holes that are 105 mm [4.135in] away from one another, with a depth of approximately 15 mm [0.59in], **Fig. 03**.
  - o One part of the sensor cable, **Fig. 04**, approximately 500-700mm [19.7-27.5 in], must be wound within the recess formed in the sensor support, see **Fig.05**.
  - o Another hole behind the grille must be made to lead the cable toward the outside, to then be connected to the compressor control unit. The maximum distance covered by the length of the cable is approximately 3.0 m [120.0 in].
  - o The temperature sensor must then be connected to the Secop/Danfoss control unit on the “C” and “T” pins. The two cables can be connected in any manner.

- **Positioning and fastening the digital display:**

**Do not install the display inside the refrigerator.**

- o **Wall display.**
  - If you wish to affix the display to the wall, you must choose the containing box without edges, see **Fig. 06**, position it on the wall where it is to be fastened and mark the two holes on the bottom of the box on the wall to insert the fastening screws and the centre of the central hole used for cable passage, see **Fig. 06**
  - Use the hole cutter to make a hole with a min. diam. 20 [0.79in] mm on the panel at the marked central point. This hole will be

used for the passage of cables and to house the rubber gland positioned on the box.



o **Flush mounted display.**

- If you wish to build in the display, you must choose the box with an edge, see **Fig. 07**.
  - To install the flush mounted box, you will need a cutter to create holes with diam. starting from 51mm [2.00 in], similar to the one illustrated in **Fig. 08**.
  - The end of the manual contains a page with a template with the shape of the recessed part to be made with actual dimensions, see **Fig. 10**. There are 4 points present inside the drawing. These are used to precisely determine where the drill guide hole shall be made.
  - Position this sheet on the panel where you will be installing the flush mounted display and make the 4 guide holes using the 4 points drawn on the template, see **Fig. 10,11,12**.
  - Make use of a file to eliminate excess material between one milling and another so that the top and bottom surfaces are linear, **Fig. 13**. We recommend filing from the outside toward the inside to avoid damaging the outer finish of the panel, which could chip. Take care not to file off too much material, or the hole could become visible and unattractive. Therefore, we suggest trying several times to see if the box fits into the hole without excessive force and filing only what is necessary for it to fit properly into the recessed housing **Fig. 14**. To fasten the box, simply apply marine silicone on the internal back corner edge, or else use a light metal bracket (not supplied) fixed through two holes on the bottom of the box itself.
- o **Inserting the frame and the display on the frame.**
- Find the display support frame and fasten it on the box using two M2.5 screws. Tighten them completely until there is increased resistance to rotation. Make sure that the head of the screw is flush with the support plane **Fig. 16**.
  - Find the connection cable between the display and the control unit, see **Fig. 17**, insert the cable through the wall. For safety

purposes, if the cable may be pulled, insert a plastic clamp on the cable near the rubber gland **Fig. 18**. Insert the white 3-pin connector on the display circuit board **Fig. 19-20**.

- Insert the overhanging part of the circuit board under the edge of the frame, tiling the display. Then delicately lower it until you feel resistance to insertion **Fig. 21-22**.
- At this point, rest two left hand fingers and two right hand fingers on the 4 buttons, press the board forward and slightly downward. Once some resistance has been exceeded, the board will inserted inside the designated housing **Fig. 23-24**.
- To remove the display from the support frame, use a flat-bladed screwdriver with maximum dimensions 0.5x3mm [0.02x0.12in], insert the tip of the screwdriver inside the extraction position, see **Fig. 25** for a depth of approximately 10mm [0.4in], push downward slightly until the display lifts from the housing. The display should now come out from the housing, possibly with the aid of a finger to carefully lift the bottom central part of the board **Fig. 26**.

## Getting started:

### Functions:

- The Digital Display has the direct functions of:
- Turning the product on and off without opening the refrigerated compartment
- Instant display of the actual temperature inside the refrigerated compartment
- Display and/or change of the set temperature with a simple press of the up and down keys
- Selection of permanent energy savings operation
- Instant display of any operating faults
- The product is equipped with a **Soft Start** function. The number of compressor revolutions is kept to the minimum allowed for approximately 30 sec. at every start of the compressor. This allows you to balance the internal pressures on the gas circuit, preventing possible compressor blocks and allowing the control unit to compare and process all the data set and collected and decide whether to keep an energy-saving configuration or increase cooling power.



## ISOTHERM Digital Display

---

- Possibility of selecting and checking the temperature within a wide-scale range from that of the refrigerator and that of the freezer
- Possibility of selecting temperature indication in Celsius or Fahrenheit
- Possibility of operation with the maximum level of performance or energy saving
- Possibility of selecting 3 different battery protection levels and resulting compressor operation
- Possibility of setting temperature offset for 3 different temperature ranges
- Possibility of sub-cooling in the event of an available surplus of energy
  
- **Description of the functions of buttons present on the Display Fig.27:**
  - o **Direct functions**
    - **1** On button
    - **2** ECO / ITC function change button
    - **3** Display
    - **4** ITC active function LED
    - **5** ECO active function LED
    - **6** Button for temperature value decrease or menu scrolling
    - **7** Button for temperature value increase or menu scrolling
  
  - o **Description:**
    - **«1»** Unit On and Off button. To switch on the refrigerator, press button **«1»**. The compressor will switch ON with factory pre-set settings. The temperature shown on the display is in degrees centigrade and corresponds with room temperature when starting up for the first time.
    - **«2»** Press button 2 to activate the ECO or ITC mode, alternatively. When one of the two functions is active, the corresponding LED under the display will light up.
    - With ECO function active, the refrigerator will operate at minimum power, in energy-savings mode. Achievement of the set temperature cannot be guaranteed in this mode.
    - With the ITC function active, FAST COOLING activates, or rather

the compressor is enabled to operate at maximum revolutions (3500 rpm) if voltage conditions permit doing so. See the paragraph on battery protection level.

- «3» Segment display, indicates the instantaneous temperature in the area in which the temperature sensor has been installed. If buttons «6» or «7» are pressed, flashes to indicate the set temperature and any new temperature set if buttons «6» or «7» are pressed again. To store temperature, wait approximately 8 sec. At that point, the display will go back to showing the temperature taken by means of the temperature sensor. Otherwise, you can more quickly store the new temperature by pressing button «2».
  - «4» Indicates when you are in ITC mode (standard).
  - «5» Indicates when Eco mode is active.
  - «6» increases the number or data when the display is in data setting mode.
  - «7» decreases the number or data when the display is in data setting mode.
- **Equipped with an advanced function menu where you can:**
- o Select 3 possible battery protection values
  - o Define temperature offset for 3 operating temperature ranges
  - o Set degrees in Centigrade or Fahrenheit
  - o Select permanent Over Cooling function, when the system has excess voltage/power available proportionate to the level of battery saving selected
  - o Define the minimum temperature setting limit
- **Sub-menu Configuration functions:**
- To enter into display set-up functions (settings):
- o Switch off the system if on.
  - o Simultaneously hold and press the buttons: «2», «6», and «7» for approximately 6 sec.
  - o Once you have entered into the configuration menu, parameters are arranged in a drop-down menu and you can scroll through them using buttons «6», «7» and you can modify a desired parameter by pressing button «2». Again use buttons «6», «7» to change the parameter

## ISOTHERM Digital Display

---

setting, save it and exit from the parameter by pressing button «2» again or waiting approximately 8 sec.

o The menu is composed of the following parameters:

- **PRO [Battery protection level]**

The **battery protection level** is intended as the voltage detected at the main power leads on the control unit and not the leads on the battery, so that the data does not include any line voltage drops along the power line between the battery and the control unit. For this reason, it is very important to comply with cable cross sections in ratio to its length and the main power voltage (12 or 24Vdc). Specifications are indicated in refrigerator manuals.

- **OF1 for Temperature Offset higher than -6°C (21.2°F)**

- **OF2 for Temperature Offset between -6°C (21.2°F) and -12°C (10.4°F)**

- **OF3 for Temperature Offset lower than -12°C (10.4°F)**

**Temperature offset** is intended as the adjustment of the difference between the actual temperature inside the refrigerated compartment and the temperature shown on the display.

After a few hours of refrigerator operation, insert a digital thermometer (not included) inside the compartment in the position where you wish to have a more precise temperature with respect to the other part of the compartment and check that the temperature indicated on the display coincides with the temperature read on the digital thermometer. If it does not coincide, change the **Offset** until the temperature read on the display coincides with the temperature indicated on the digital thermometer. In this case, follow the instructions indicated in the "Sub-menu Configuration functions" paragraph described above, selecting the OFFSET OF1 or OF2 or OF3 function in reference to the temperature range read on the digital thermometer.

Once you have entered into the OFFSET function, increase or decrease data by pressing buttons «6» or «7». If the display indicates a temperature higher than that indicated on the digital thermometer, set a negative value equal to the difference read between the digital display and the thermometer. If the display indicates a temperature lower than that indicated on the digital thermometer, set a positive value equal to the difference read between the digital display and the thermometer.

Save and exit from the function by pressing button «2» again or waiting approximately 8 sec.

- **F-C [To set the measurement unit to Fahrenheit or Centigrade]**
- **O C [Activates or deactivates Over Cooling]**





**Over Cooling** is intended as extra cooling with respect to the set temperature. It is only active when the ITC function is activated and remains active until turned off by the user. This function allows you to accumulate cooling energy within food and drink which will then be released when the surplus energy is no longer available, to save energy when the power will be supplied by the battery only.

It is only active when the system detects a surplus of energy with batteries fully charged, the motor on and the battery charger active.



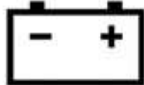

- The system sub-cools up to 3°C (5.4°F) lower with respect to the temperature set with the temperature limit at 0°C (32°F).
- If the system is configured to operate as a freezer for temperatures below -4°C (24.8°F), the system will sub-cool up to 1°C (1.8°F) lower with respect to the set temperature.
- Over Cooling is irrelevant to the system for all temperatures set between 1° and -3°C (33.8 and 26.6°F).
  - **rOF [Refrigerator or Freezer]** defines the minimum temperature limit for setting from the panel from +6°C to -22°C (+42 to -7°F).
- o To exit from the sub-menu function, press button «1» or wait approximately 10 sec.

# ISOTHERM Digital Display

## - Sub-menu Configuration Functions illustration:

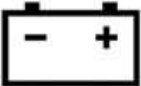
- o PRO [Battery protection level]
- o Key:
  - **Cut-Out**, switch-off voltage
  - **Cut-In**, switch-on voltage
  - **Full Speed**, voltage at which the system enters into maximum cooling power function
  -  Battery saving level
  -  Low,  Medium,  High
  -  Shown on the Battery Protection display.

TAB.01

BATTERY PROTECTION							
		12Vdc			24Vdc		
		Cut-out Comp. off	Cut-in Comp. on	Full speed / Over- cooling thresh- old	Cut-out Comp. off	Cut-in Comp. on	Full speed / Over- cooling thresh- old
	---	9.9	11.2	12.4	21.6	23.0	24.1
	--- ---	10.4	11.7	12.9	22.6	24.0	25.2
	--- --- ---	11.3	12.5	13.7	24.2	25.6	26.8

## - ITC mode operation and control mode table

(in Eco Mode, the compressor is limited to 2500 rpm)

o **Key:**

- **COMPRESSOR OFF**, indicates compressor status [Off] the moment you enter the specified voltage range.
- **COMPRESSOR ON**, indicates compressor status [On] the moment you enter the specified voltage range.
- **RPM**, indicates the number of revolutions in which the compressor can be found in reference to compressor status and to power voltage.

TAB.02

	Compressor Status	
	Compressor Off	Compressor On
---	<b>RPM</b>	<b>RPM</b>
<b>12Vdc</b>	<b>RPM</b>	<b>RPM</b>
$V < 9.9$	0	0
$9.9 < V < 11.2$	0	2500
$11.2 < V < 12.4$	2500	2500 - 3500
$V < 12.4$	3500	3500
<b>24Vdc</b>	<b>RPM</b>	<b>RPM</b>
$V < 21.6$	0	0
$21.6 < V < 23.0$	0	2500
$23.0 < V < 24.1$	2500	2500 - 3500
$V < 24.1$	3500	3500

# ISOTHERM Digital Display

TAB.03

	Compressor Status	
	Compressor Off	Compressor On
---	RPM	RPM
---		
<b>12Vdc</b>	<b>RPM</b>	<b>RPM</b>
$V < 10.4$	0	0
$10.4 < V < 11.7$	0	2500
$11.7 < V < 12.9$	2500	2500 - 3500
$V < 12.9$	3500	3500
<b>24Vdc</b>	<b>RPM</b>	<b>RPM</b>
$V < 22.6$	0	0
$22.6 < V < 24.0$	0	2500
$24.0 < V < 25.2$	2500	2500 - 3500
$V < 25.2$	3500	3500

TAB.04

	Compressor Status	
	Compressor Off	Compressor On
---	RPM	RPM
---		
---		
<b>12Vdc</b>	<b>RPM</b>	<b>RPM</b>
$V < 11.3$	0	0
$11.3 < V < 12.6$	0	2500
$12.6 < V < 13.8$	2500	2500 - 3500
$V < 13.8$	3500	3500
<b>24Vdc</b>	<b>RPM</b>	<b>RPM</b>
$V < 24.2$	0	0
$24.2 < V < 25.6$	0	2500
$25.6 < V < 26.8$	2500	2500 - 3500
$V < 26.8$	3500	3500

## DC 12/24Vdc 101N0212 CONTROL UNIT ELECTRICAL CONNECTIONS

Connect all components (See Fig. 31) as per the following wiring diagram:

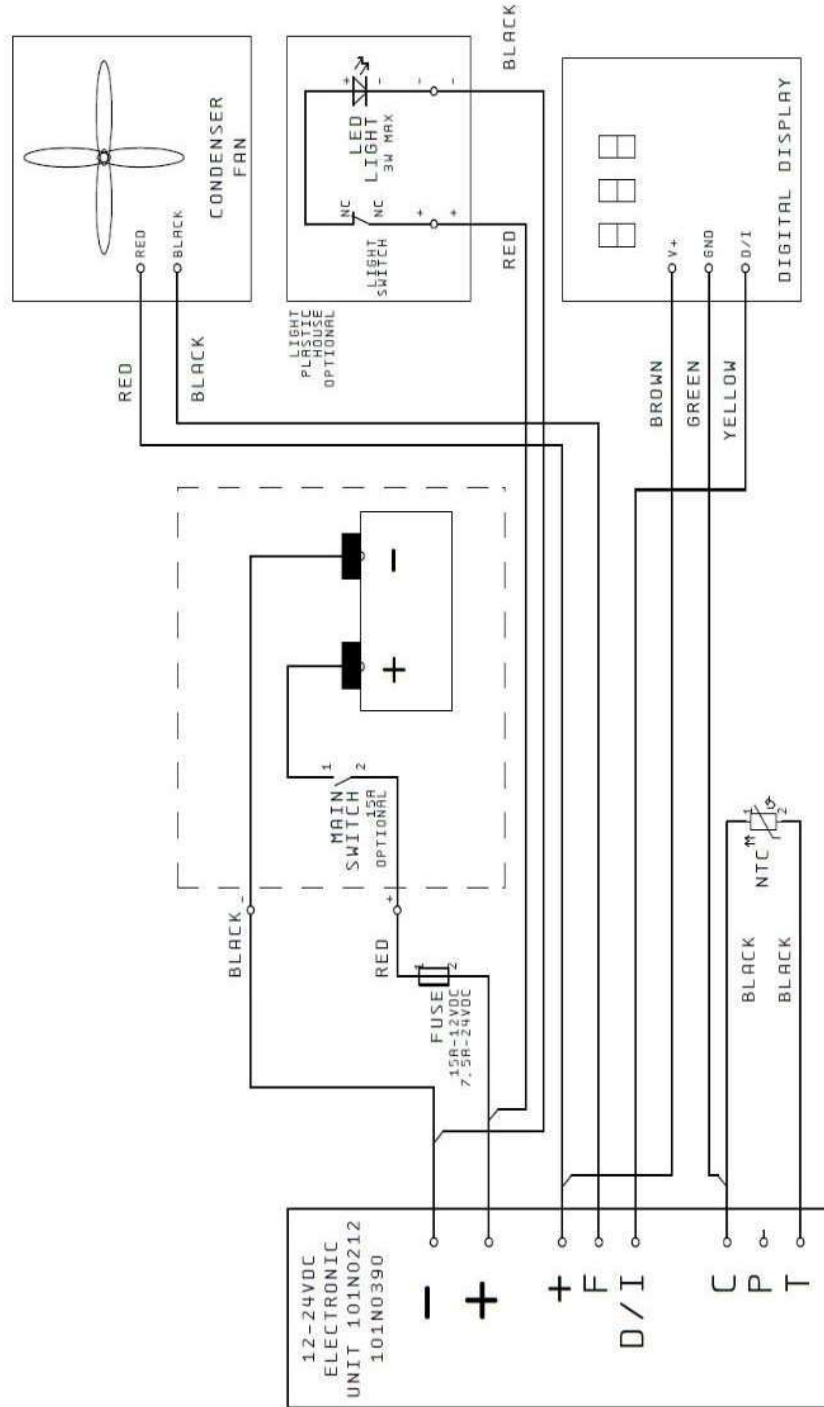

Notes: in control units for DC power supply only, if the condenser fan is not present you will need to remove or protect the second display power wire connection [+ brown]) Fig. 29.



## ISOTHERM Digital Display

---

### **AC/DC 12/24Vdc 115-230Vac 101N0510 CONTROL UNIT ELECTRICAL CONNECTIONS**

Connect the stabiliser filter when using an AC/DC control unit (See the wiring diagram on the next page, accessory ACC01).

Note: Cables are marked with letters. It is important to comply with the letters marked on cables with the same letters indicated on the control unit.

### **LIGHTING WITH AC/DC 12/24Vdc 115-230Vac 101N0510 CONTROL UNIT**

It is essential to connect the extension supplied only when a lighting system is present (See the wiring diagram on the next page, accessory ACC02).

Note: Cables are marked with letters. It is important to comply with the letters marked on cables with the same letters indicated on the control unit.

## AC-DC 12/24Vdc 115-230Vac 101N0510 CONTROL UNIT WIRING DIAGRAM

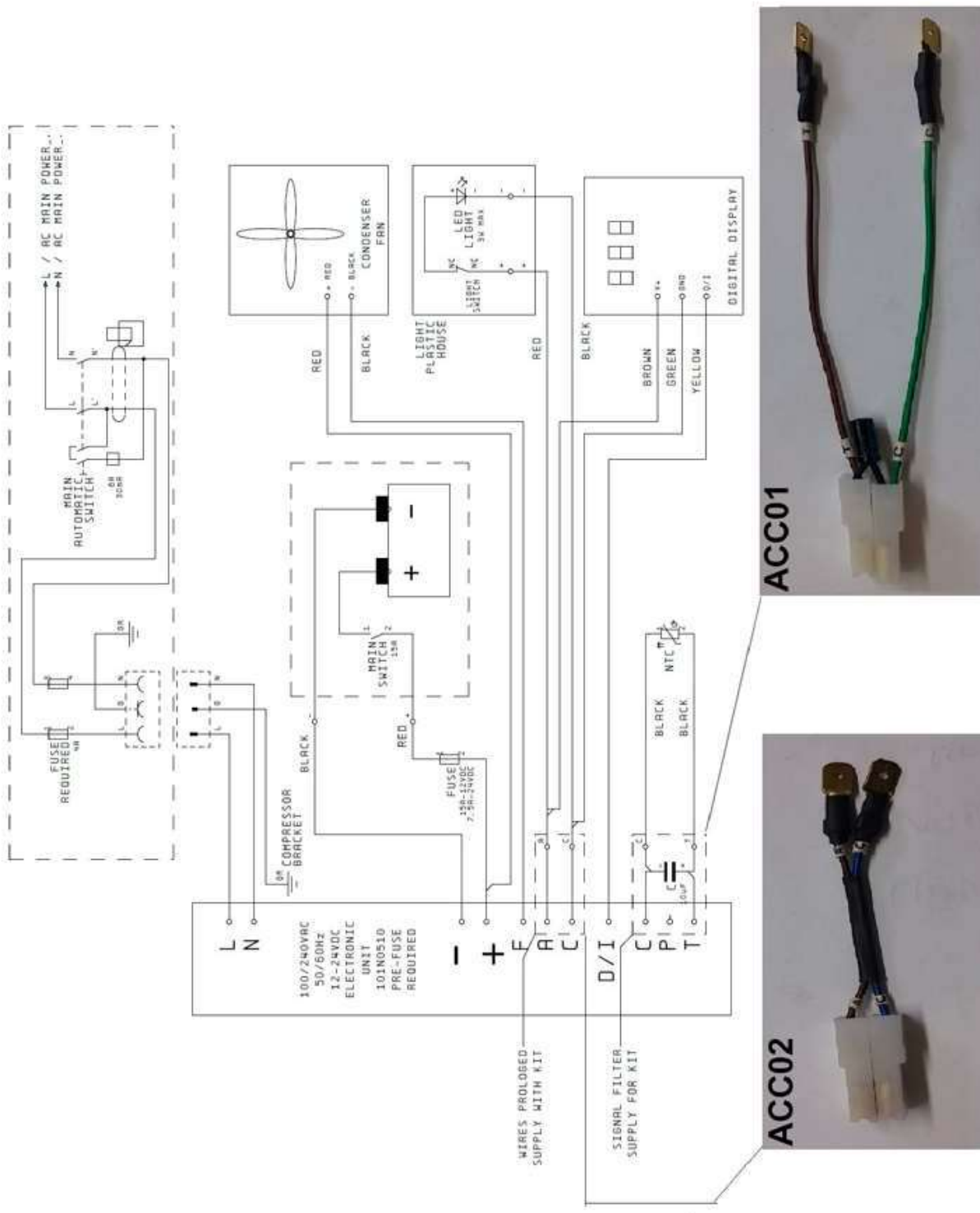

# ISOTHERM Digital Display

## Troubleshooting

-	No communication between the display and the control unit. The <b>horizontal scrolling line</b> appears on the DISPLAY for a few seconds, the refrigerator switches off.
<b>LO</b>	Insufficient voltage (Volts below the cut-out value).
<b>R2</b>	The fan absorbing a value exceeding 0.6A from the control unit.
<b>R3</b>	Compressor blocked.
<b>R4</b>	The refrigeration system is too loaded with gas and the compressor is not able to operate at the minimum RPM.
<b>R5</b>	Room temperature is too high.
<b>R6</b>	The temperature sensor is short-circuited or not correctly connected to the control unit.
<b>Notes</b>	<p>If the cooling system is struggling to reach the set temperature, check that:</p> <ul style="list-style-type: none"> <li>- The voltage on the control unit leads upon start-up exceeds that indicated in table <b>TAB.01</b> under the item <b>Full Speed</b> inherent to the 12/24vdc voltage system used.</li> <li>- The insulation is thick enough in relation to the volume and type of FRIDGE or FREEZER system required, see cooling unit manual.</li> <li>- The compartment volume does not exceed the maximum volume allowed by the cooling system distinguished as a fridge or freezer unit. The fridge unit cannot be used as a freezer if the volume is not decreased at least 2/3 and insulation increased. See the cooling unit use and maintenance manual.</li> <li>- The correct temperature for the fridge system is approximately +5°C. For a freezer unit, and directly proportioned to the value, type, and thickness of insulation, temperatures may vary from -6°C to -18°C.</li> <li>- For all other cases, see the unit manual or contact an IWM service centre.</li> </ul>

