



WASHDOWN/BAITWELL — 31605-SERIES SHOWER DRAIN/GENERAL PURPOSE — 31610-SERIES

Models 31605, 31610-Series

PAR-MAX 3 – 3.5 GPM (13.2 LPM)

FEATURES

- Self-Priming to 10 ft. (3 m)
- Run Dry Without Damage
- Smooth Flow
- Four Piston, Diaphragm Pump
- Powerful Motor with Thermal Overload Protection
- Snap-in Ports
- Waterproof Coating (31605-Series)
- Pressure Switches with Rubber Boot (31605-Series)
- Meets USC 49 CFR 171.101-101.4 (Click here for Pricing/Ordering)
- Meets EN 50081-1 Electro Magnetic Compatibility

GENERAL APPLICATIONS

31605-Series – For commercial duty washdown/baitwell applications. Corrosion resistant coated motor for harsh environment use. Baitwell is a full flow application.

31610-Series – Compact, self-priming pump for shower drain applications. Run dry without damage. Pump shower and grey water. Inlet and outlet ports fit 3/4" (19 mm) hose. Oil resistant parts allow pumping of diesel fuel.



SPECIFICATIONS

- Pump Body – Glass Filled Polypropylene
- Pump Design – Multi-Chamber Diaphragm
- Suction Lift – Self Priming to 10 ft. (3 m)
- Ports – 3/4" (19 mm) Hose Barb or 1/2" (13 mm)
- Motor – Permanent Magnet
- Shipping Weight – 5 lb (2.1 kg)

WARNING! Explosion hazard. Do not pump gasoline, solvents, thinners or other flammable liquids. To do so can cause an explosion resulting in injury or death.



VARIATIONS MODELS	APPLICATION	GPM/LPM	VOLTS	SHUT-OFF	AMP DRAW		FUSE
				psi (bar)	@ 10 psi	@ 40 psi	BREAKER*
PAR-MAX3							
31605-0092	WASHDOWN/BAITWELL	3.5/13.2	12 Vdc	50 (3.5)	5	9	10
31605-0392	WASHDOWN/BAITWELL	3.5/13.2	12 Vdc	50 (3.5)	5	9	10
31605-0094	WASHDOWN/BAITWELL-	3.5/13.2	24 Vdc	50 (3.5)	3	5	7
31605-0394	WASHDOWN/BAITWELL-	3.5/13.2	24 Vdc	50 (3.5)	3	5	7
31610-0092	SHOWER DRAIN/G.P.	3.5/13.2	12 Vdc	N/A	5	N/A	10
31610-0094	SHOWER DRAIN/G.P.	3.5/13.2	24 Vdc	N/A	3	N/A	7

* Customer supplied, not included with pump.

DIMENSIONAL DRAWINGS — INCHES (MILLIMETERS)

INSTALLATIONS

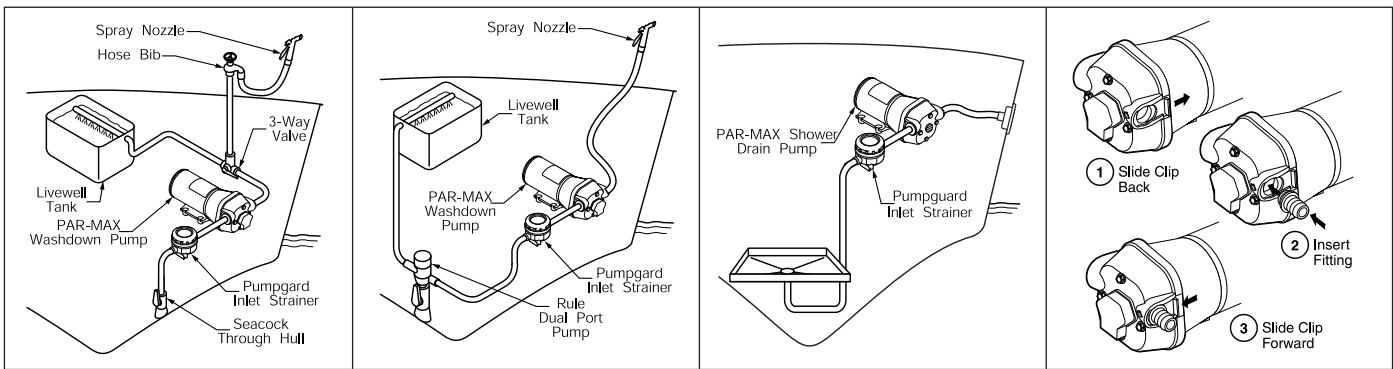

Fig. 1
31605-Series

Fig. 2
31605-Series w/Rule® Dual Port

Fig. 3
31610-Series

Quick Easy Installation
Versatile Snap-in Ports

MOUNTING

The PAR-MAX pumps are self-priming and may be located above or below the water supply in a dry location. To vertically mount these units, it is best to do so with the motor on top. This will prevent water dripping on motor in the event of a leak. Place pump on a solid surface and secure with the four mounting screws being careful not to compress the rubber grommets which act as shock absorbers.

PLUMBING

IT IS RECOMMENDED THAT MARINE GRADE REINFORCED HOSE BE USED FOR ALL PLUMBING WITH THESE MODELS OF PAR-MAX PUMPS.

31605-Series – Washdown/Livewell (Fig. 1)

Install the Pumpgard strainer (provided) to the hose from the water source (thru-hull seacock or water tank). Connect the Pumpgard strainer to the pump inlet port. Connect the pump discharge to a 3-way valve or T (if livewell has a shutoff valve). Connect to livewell and to hose bib. From hose bib use new spray nozzle.

31605-Series – w/Rule® Dual Port (Fig. 2)

Install Rule® dual port pump to seacock. Connect hose from dual port pump to livewell/baitwell tank (see Fig. 2). Connect washdown hose from dual port pump to Pumpgard strainer, connect to pump inlet port. Connect hose from pump outlet to pressure nozzle.

31610-Series – Shower Drain (Fig. 3)

Install hose from shower drain to Pumpgard strainer. Connect Pumpgard to pump inlet port. Install hose from pump outlet port to discharge thru-hull or grey water holding tank.

Note – Pumpgard strainers should be mounted in the most accessible place possible to make periodic cleaning of the screen easier.

WIRING

In an easily accessible location, install a switch to control electricity to the pump. The switch should have an amp rating equal to or greater than the fuse size specified for the pump. Turn the pump off when not used for extended periods or when the tank is empty.

The electrical circuit should be protected with an over-current protection device in the positive lead. See chart for proper size. The pump circuit should not include any other electrical loads. The open terminal on the pressure switch is positive. Black wire from the motor is negative.

Select wire size from chart below. Use total length of wire from the battery to pump and return. Chart allows for 3% voltage drop. If in doubt, use next larger wire size.

If you are not familiar with applicable electrical standards, have the unit installed by a qualified electrician.

After installation, check the voltage at the pump motor. Voltage should be checked when pump is operating. Full voltage must be available at the pump motor at all times.

Total length in feet	0-20 (0-6 m)	20-35 (6-11 m)	35-55 (11-17 m)
12 Volt	#14 AWG (2.5 mm ²)	#12 AWG (4 mm ²)	#10 AWG (6 mm ²)
24 Volt	#16 AWG (1.5 mm ²)	#14 AWG (2.5 mm ²)	#12 AWG (4 mm ²)

OPERATION

1. Open seacock (washdown or livewell applications).
2. Open hose bib and/or spray nozzle (31605-Series) or make sure discharge thru-hull is clear (31610-Series).
3. Turn on pump.
4. 31605-Series. Close spray nozzle/hose bib when water runs free of air. Pump is now ready for automatic demand operation.
5. 31610-Series. Pumps do not have a pressure switch and are usually switched manually.
6. For prolonged operation, pump must operate at full open flow.

CAUTION!



Motor case will get hot. Prolonged contact during operation may cause a burn.



WARNING: DISCONNECT POWER TO PUMP AND OPEN VALVE TO RELIEVE WATER PRESSURE PRIOR TO SERVICING PUMP

EXPLODED VIEW

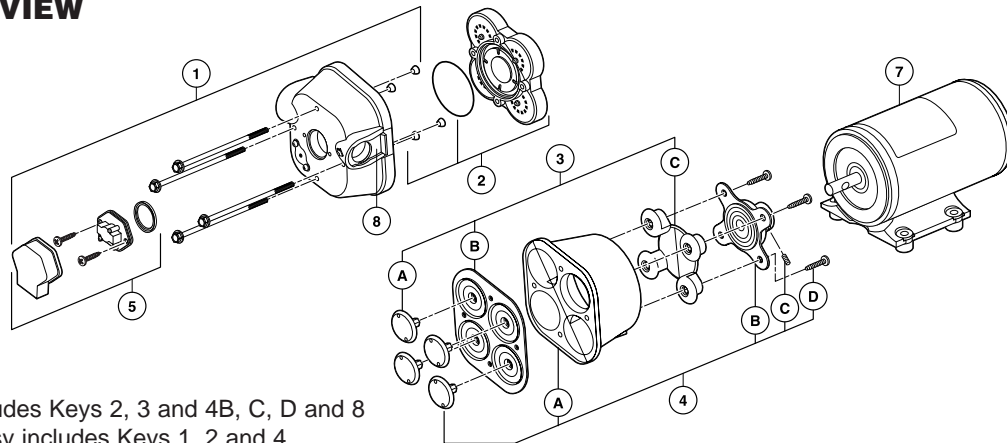

* Service Kit includes Keys 2, 3 and 4B, C, D and 8

** Pumphead Assy includes Keys 1, 2 and 4

KEY	DESCRIPTION	QTY	31610-SERIES — PART NO.	31605-SERIES — PART NO.
1	Upper Housing with Switch	1	18910-4000	18910-4050
2	Valve Kit	1	18911-7010	18911-7030
3	Diaphragm Kit	1	18912-3050	18912-3040
4	Lower Housing Kit	1	18915-9005	18915-9002
5	Pressure Switch	1	N/A	18916-0050
*6	Service Kit	1	18920-9053	18920-9043
7	Motor Kit – 12V EMC Compatible	1	18919-0139	18919-0139
	24V EMC Compatible	1	18919-1061	18919-1061
8	Slide Clips	1	30648-1000	30648-1000
**9	Pumphead Assy.	1	18914-6300	18914-6350
	Pumpgard Strainer	1	46400-0000	46400-0000
	Spray Nozzle US	1		30703-1000
	Spray Nozzle EC	1		30704-1000

DISASSEMBLE

Pressure Switch (5)

1. Disconnect power to pump and open a faucet or valve to relieve system pressure.
2. Remove Rubber Boot, then remove the two visible Pressure Switch Screws located on each side of the Pressure Switch (5).

Upper Housing (1)

3. Slide Port Clip (8) back and unplug from Tank Plumbing.
4. Loosen but DO NOT remove the four Pump Head Screws and carefully remove Upper Housing Assembly (1).
5. Remove Check Valve (2) and inspect for debris.

Check Valve Assembly (2) Follow Steps 1, 3 & 4

6. Inspect Check Valve (2) and O-Ring

Lower Housing (4) Follow Step 1, 3 & 4

7. Remove Rubber Plugs on housing (4-A) to access Allen Screw.
8. Rotate Lower Housing (4), so access notch is aligned with Cam Bearing Set Screw (4-C), loosen set screw with a 1/8" Allen Wrench and slide pump head off motor shaft.

Diaphragm (3-B)

9. Loosen four cam piston screws with Phillips head screw driver and pull apart cam (4-B) from Inner Pistons (3-A). (Both pistons (3-A & C) should be replaced when a new Diaphragm (3-B) is installed.)

Motor (7) Follow steps 1, 3, 4, 7, & 8

REASSEMBLE

Diaphragm (3-B)

1. Insert Outer Pistons (3-C) into Lower Housing (4-A) by bending pistons at center fold.
2. Placing the Diaphragm (3-B) (flatter side of Diaphragm facing the motor) on the Lower housing (4-A). Press each Inner Piston (3-A) through the Diaphragm and Lower Housing (4A) into Outer Piston (3-C). Hex stem of Inner Pistons (3-A) must be aligned into hex holes in Outer Pistons (3-C). Tighten cam piston screws partially, center piston in diaphragm, and tighten screws securely (18 in. lbs. torque). Also, the Outer Pistons (3-C) must be aligned with alignment slots on Cam Assembly (4-B) making sure screw holes align in cam assembly, otherwise diaphragm will leak.

Cam Bearing (4-B)

3. Place Cam Bearing (4-B) over Inner Pistons (3-C) and tighten down with four Phillips Head Screws. (18 in. lbs. torque)

Lower Housing (4) to Motor (7)

- Coat motor shaft with grease prior to installing Cam Bearing (4-B).
4. When installing the Lower Housing (4), rotate access notch to align with Cam Bearing Set Screw (4-C).
5. Attach Cam Bearing (4-B) to motor shaft indentation with Cam Bearing Set Screw (4-C). (35 in. lbs. torque)
6. Reinsert new Notch Plugs.

Check Valve (2)

7. Place Ferrules (Rubber Cones) in the Upper Housing (1) coned side first.
8. Properly seat O-Ring in Check Valve (2) and insert Check Valve (2) into the Upper Housing (1).

Upper Housing (1)

9. Place Upper Housing (1) on top of the Lower Housing (4-A) and tighten Hex Bolts (30 in. lbs. torque) through the Upper Housing (1) to the Motor.





TROUBLESHOOTING

Symptom	Possible Cause(s)	Corrective Action
Pump will not prime or retain prime after operating	<ol style="list-style-type: none"> 1. Air leak in suction line 2. Defective valve (Key 2) 3. Upper housing leaking (Key 1) 4. Suction lift too high 5. Debris in valve(s) (Key 2) 	<ol style="list-style-type: none"> 1. Repair or replace 2. Replace 3. Tighten bolts 4. Lower pump 5. Clean valve(s)
Pump runs but no fluid	<ol style="list-style-type: none"> 1. Faulty suction piping 2. Defective valve (Key 2) 3. Suction lift too high 4. Clogged inlet 5. Inlet line valve closed 	<ol style="list-style-type: none"> 1. Repair or replace 2. Replace 3. Lower pump 4. Clean or replace 5. Open valve
Motor runs too hot	<ol style="list-style-type: none"> 1. Voltage incorrect 2. Insufficient ventilation for motor 	<ol style="list-style-type: none"> 1. Check voltage 2. Insure proper ventilation
Flow rate is low	<ol style="list-style-type: none"> 1. Piping or hose is damaged 2. Clogged valve (Key 2) 3. Worn valve (Key 2) 4. Voltage incorrect 5. Tank over pressurized 	<ol style="list-style-type: none"> 1. Clean or replace 2. Clear obstruction 3. Replace 4. Check voltage 5. Check tank pressure
Pump leaks	<ol style="list-style-type: none"> 1. Upper housing loose (Key 1) 2. Pistons loose (Key 3A, 3C) 3. Pump head loose on motor 4. Switch loose (Key 5) 5. Defective Diaphragm (Key 3B) 	<ol style="list-style-type: none"> 1. Tighten screws 2. Tighten pistons 3. Tighten pump head 4. Tighten switch 5. Replace
Pump will not run	<ol style="list-style-type: none"> 1. No electricity 2. Defective pressure switch (Key 5) 3. Motor has open circuit (Key 7) 4. Thermal protector has cut off (Key 7) 	<ol style="list-style-type: none"> 1. Check connections, fuse, breakers 2. Replace switch 3. Replace 4. Allow motor to cool 14-30 min.

CONVERSION TABLE

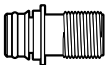
TO CONVERT	TO	MULTIPLY BY
Gallons, U.S.	Liters	3.785
Liters	Gallons, U.S.	0.264
Pounds/Sq. Inch	Bar	0.069
Bar	Pounds/Sq. Inch	14.5
Fahrenheit	Celsius	(°F-32) .556
Celsius	Fahrenheit	(°C X 1.8) + 32

**ACCESSORIES
SNAP-IN PORT SYSTEM**

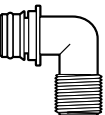
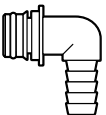
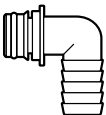
						
30649-1000 30649-1001	30654-1000 30654-1001	30653-1000 30653-1001	30650-1000 30650-1001	30655-1000 30655-1001	30651-1000 30651-1001	30642-1000 30642-1001
SNAP-IN PORT x 1/2" MALE QEST. STRAIGHT	SNAP-IN PORT x 1/2" HOSE BARB STRAIGHT	SNAP-IN PORT x 3/4" HOSE BARB STRAIGHT	SNAP-IN PORT x GARDEN HOSE STRAIGHT	SNAP-IN PORT x 1/2" MALE QEST. 90° ELBOW	SNAP-IN PORT x 1/2" HOSE BARB 90° ELBOW	SNAP-IN PORT x 3/4" HOSE BARB 90° ELBOW

NOTE:
Use **306XX-1000** Series EPDM for potable water.
Use **306XX-1001** Series Buna for oil or diesel fuel.

Jabsco

PumpAgents.com - buy pumps and parts online

THE PRODUCTS DESCRIBED HEREIN ARE SUBJECT TO THE JABSCO ONE YEAR LIMITED WARRANTY, WHICH IS AVAILABLE FOR YOUR INFORMATION UPON REQUEST.

For technical advice or service please take your pump into your local pump service center.
To order pump or parts or for pricing please go to the following links :

[Jabsco Pumps Home >>](#)

[Jabsco Pumps stock list >>](#)