

## Impeller Replacement Kits

FOR ENGINE WATER COOLING PUMPS



Second to an actual mechanical failure of the engine itself, a malfunction of the engine cooling pump would lead to catastrophic results. SPX FLOW's Johnson Pump engine cooling pumps are designed to the demands of engine manufacturers and are built to take rough treatment.

SPX FLOW supplies engine cooling pumps to the world's leading marine motor manufacturers, not just because of our renowned pumps; but also because of the heart of an engine cooling pump: the impeller.

This seemingly unassuming bit of rubber sees to it that the engine always has a sufficient flow of cooling water. If the impeller doesn't do its job, either through wear and tear, fatigue or wrong dimension, you could be left dead in the water with the likelihood of a significant engine repair bill in your near future.

The Johnson Pump brand is synonymous with outstanding impeller performance and quality.

Based in Charlotte, North Carolina, SPX FLOW (NYSE: FLOW) is a multi-industry manufacturing company with operations in more than 35 markets worldwide.

SPX FLOW's innovative, world-class products and highly-engineered solutions are helping to meet the needs of a constantly developing world and growing global population. You'll find our innovative solutions in everything from dairy plants and power plants to oil and gas pipelines, the power grid. SPX FLOW is really everywhere you look.

We help our customers around the globe expand and enhance their food and beverage, power and energy and industrial production processes. For more information, please visit [www.spxflow.com](http://www.spxflow.com)

## Impeller replacement kits

### Lasting quality with SPX FLOW Johnson Pump brand impellers

For the well-being of your boat engine your water cooling pump must be able to supply a minimum specified continuous flow of cooling water. The flexible impeller in your pump, which provides this pumping action, is a wear part. Over time the impeller will lose its ability to maintain the pressure needed for the flow of cooling water and must be replaced.

A good quality impeller will provide you with many months of problem-free operation. For an impeller of lesser quality the performance can degrade so rapidly that you, at best, must replace the impeller more often; at worst, you could be left adrift with engine damage.

SPX FLOW engineers Johnson Pump impellers for outstanding performance!

## What makes Johnson Pump *the* original and replacement impeller of choice?

With SPX FLOW Johnson Pump you get:

### PERFORMANCE

#### STABLE PRESSURE DELIVERY OVER TIME

- Ensures correct cooling flow
- Significantly longer service life...in some applications up to 4x longer than the competition (at a given duty cycle).

#### EXCELLENT SELF-PRIMING CAPABILITY

- Ensures sufficient cooling directly at start up

#### CORRECT IMPELLER DIMENSIONS

- Our impellers are manufactured to strict tolerances for optimal functionality

#### UNIQUE MC97 RUBBER COMPOUND

- Ensures flexibility for self-priming capabilities and minimizes failure due to fatigue (broken blades). Provides stronger bonding to avoid hub slip.

### DEVELOPMENTAL KNOW-HOW

With its Johnson Pump brand SPX FLOW is an original manufacturer of world class impellers for more than 40 years

- More than 125 years of accumulated engineering time.
- Documented, standardized testing
- Continuous quality testing, annually 150,000 test hours
- In excess of 150,000 hours testing of our MC97 rubber compound

### MARINE COMPOUND 97 (RUBBER COMPOUND MC97)

One of our secrets for success is our rubber compound MC97; optimized to provide maximum life, especially for applications where the end user doesn't run the engine on a regular basis:

- Stable pressure delivery over time
- Minimized failures due to fatigue
- Minimized swelling

(Always use Johnson Pump Original Impeller Lube since many rubber compounds are sensitive to petroleum products)

## PRESSURE DROP OVER TIME FOR HIGH QUALITY AND LOW QUALITY IMPELLERS

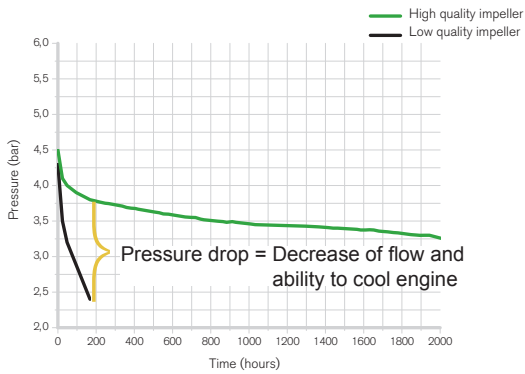

## PRESSURE DROP OVER TIME FOR JOHNSON PUMP AND TYPICAL COMPETING IMPELLERS

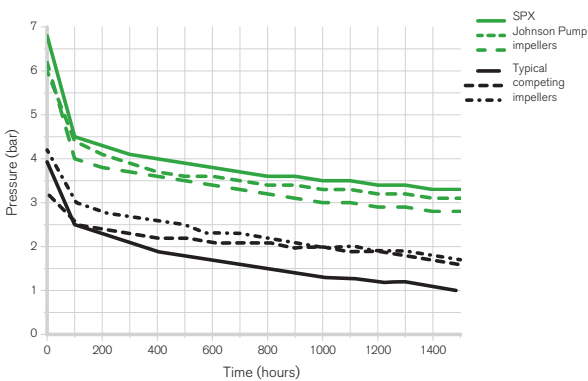

## SHERWOOD / MERCURISER REPLACEMENT PROGRAM

Sherwood / Mercrusier owners can now take advantage of premium replacement impellers from SPX FLOW Johnson Pump; documented superior to the competition. We do not venture into this market lightly. We have prepared ourselves well.

- Engineering time in excess of 2000 hours
- More than 80,000 hours of continuous testing
- Manufactured from our MC97 rubber compound

# Impeller Replacement Kits for Sherwood / Mercruiser / Jabsco

SPX FLOW JOHNSON PUMP PART NO.	SHERWOOD PART NO.	MERCURISER PART NO.	JABSCO PART NO.
09-701B-1	9959K	-	18948-0001

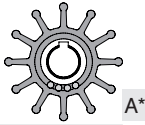

### ENGINES / PUMPS

Chris Craft; Chrysler Marine; Commander; Crusader; Glastron Boat Co.; Gray Marine; Interceptor; Onan; OMC; Pathfinder VolksWagon Eng.; Perkins Eng. U.S.; Plesurecraft Marine; Universal Medalist; Volvo Penta; Yamaha; Westerbeke 24102; Sherwood 11353; Pleasure Craft 302&351; Chris Craft 350; Onan MDL3,4

SPX FLOW JOHNSON PUMP PART NO.	SHERWOOD PART NO.	MERCURISER PART NO.	JABSCO PART NO.
09-702B-1	10615K	-	17954-0001

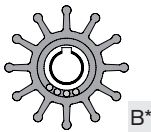

### ENGINES / PUMPS

Chris Craft; Chrysler Marine; Commander; Crusader; Escort (Skiltec); Gray Marine; Isuzu; Lenco; Marine Power; North American Engine; Onan; Osco Motors; OMC; Perkins Engine U.S.; Plesurecraft Marine; Volvo Penta; J.H. Westerbeke Corp; Crusader 97179; Chrysler 3675763; Chrysler 4142878; Cummins 4B; Onan MDL6; Chris Craft 454; Pleasure Craft 454

SPX FLOW JOHNSON PUMP PART NO.	SHERWOOD PART NO.	MERCURISER PART NO.	JABSCO PART NO.
09-703P-1	-	47-59362T	18838-0001

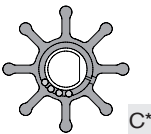

### ENGINES / PUMPS

Pump Quicksilver Model 46-72774 A32

SPX FLOW JOHNSON PUMP PART NO.	SHERWOOD PART NO.	MERCURISER PART NO.	JABSCO PART NO.
09-704BT-1	17000K	-	18958-0001

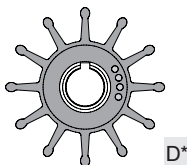

### ENGINES / PUMPS

Cummins 6B 300Hp B Series; Cummins C Series; CAT 3208; CAT 3116; CAT 3126; Deere 6076; Sherwood Pump P17 series

SPX FLOW JOHNSON PUMP PART NO.	SHERWOOD PART NO.	MERCURISER PART NO.	JABSCO PART NO.
09-705BT-1	18000K	-	-

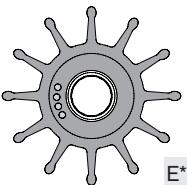

### ENGINES / PUMPS

Sherwood Pump P18 Series

\*see page 7 for impellers in scale 1 : 1

# SPX FLOW's Johnson Pump Marine Brand Original Impellers

SCALE 1:1

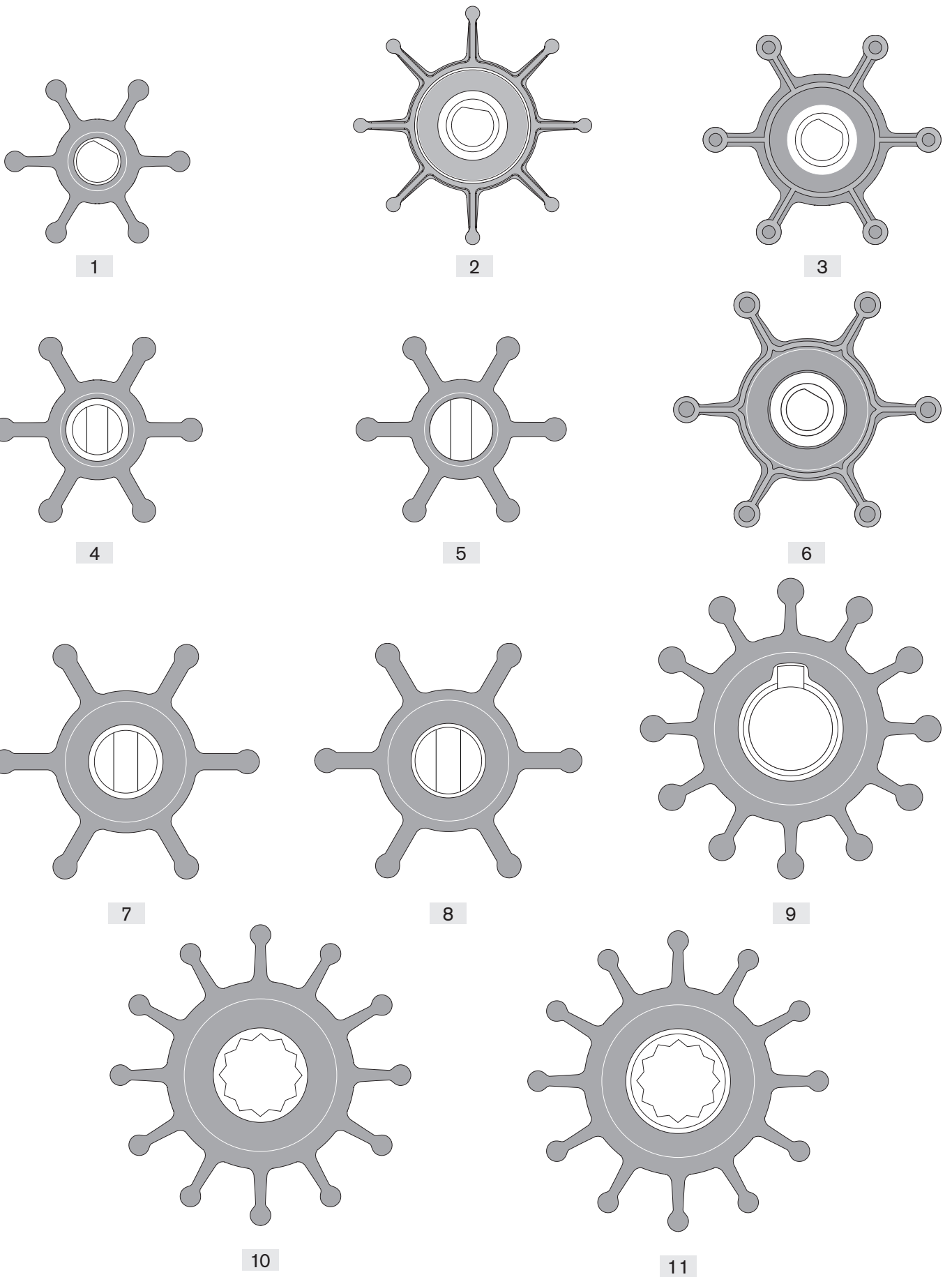

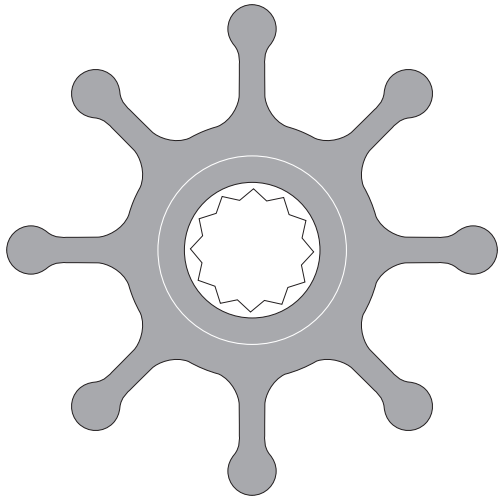

12

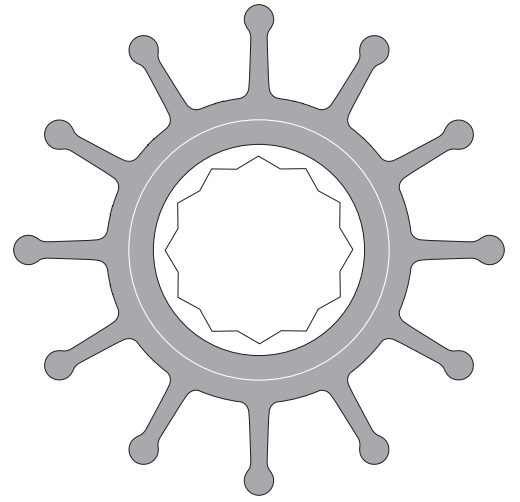

13

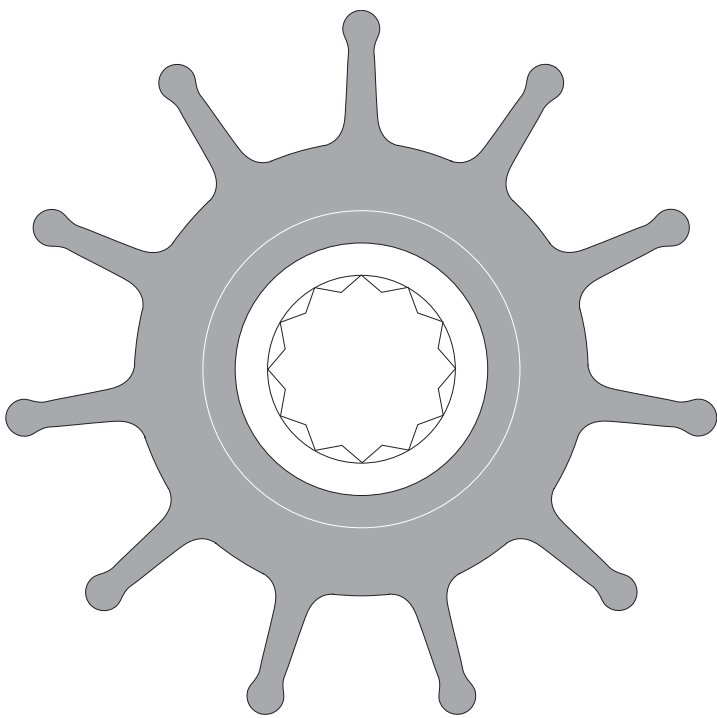

14

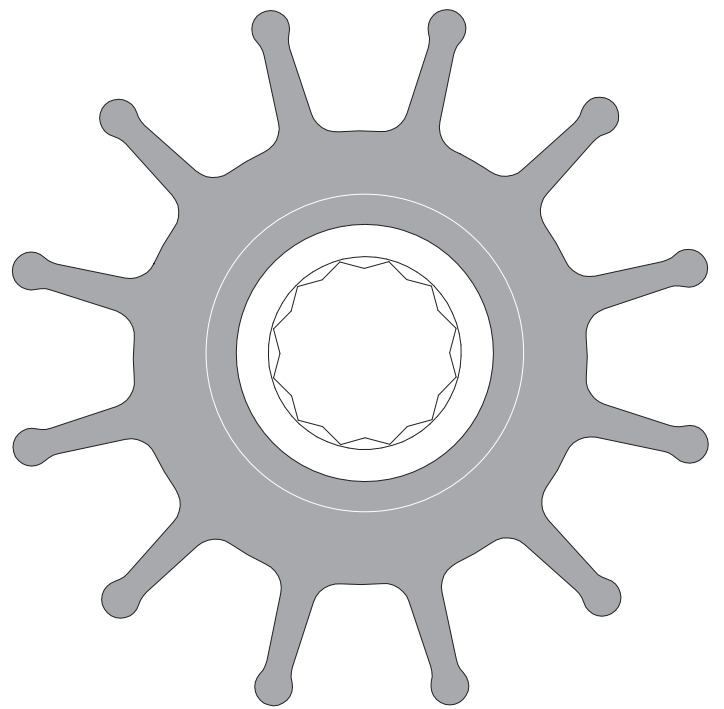

15

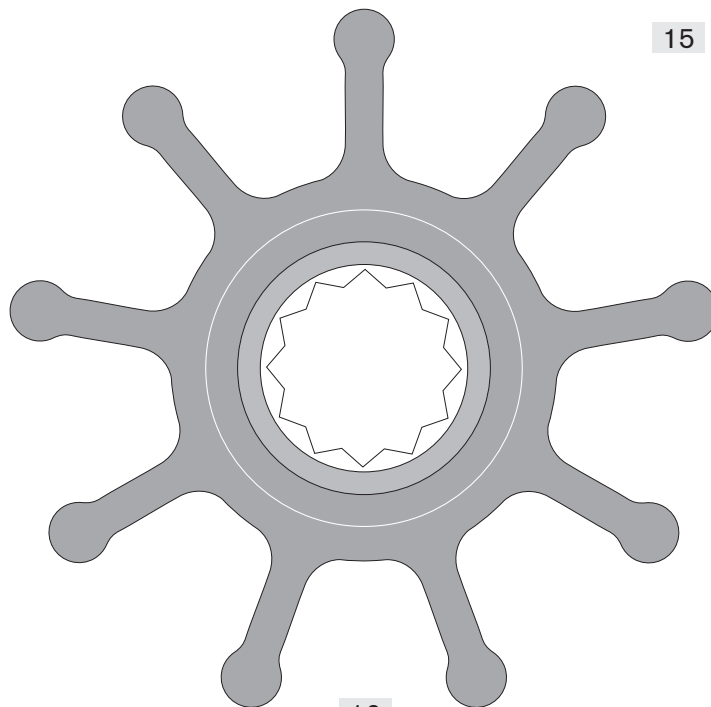

16

# SPX FLOW's Johnson Pump Marine Brand Original Impellers

REF.	PUMP	IMPELLER	MATERIAL*	OUTER DIA		INNER DIA		WIDTH		REPLACES JABSCO NO	
				MM	INCH	MM	INCH	MM	INCH	EUROPE	USA
1	F2	09-1077B-9	NITRILE	35.2	1.29	8.0 / FLAT	0.31 / FLAT	12.7	0.50		
2	F3	09-843S-9	NITRILE	45.2	1.78	8.0 / FLAT	0.31 / FLAT	12.8	0.50		
3	TA3P10	09-1052S-9	NITRILE	45.2	1.78	8.0 / FLAT	0.31 / FLAT	12.8	0.50		
4	F35	09-806B-1	MC97	40.0	1.58	9.5	0.37	19.0	0.75	4528-0001	
5	F35	09-808B-1	MC97	40.0	1.58	12.0	0.47	19.0	0.75	22405-0001	
6	F4	09-824P-1	MC97	50.8	2.00	8.0 / FLAT	0.31 / FLAT	22.0	0.87		
6	F4	09-824P-9	NITRILE	50.8	2.00	8.0 / FLAT	0.31 / FLAT	22.0	0.87	6303-0003	
7	F4	09-810B-1	MC97	50.8	2.00	12.0	0.47	22.0	0.87	18653-001	
7	F4	09-810B-9	NITRILE	50.8	2.00	12.0	0.47	22.0	0.87		
8	F4	09-1026B-1	MC97	50.8	2.00	12.7	0.50	22.0	0.87	673-0001	
8	F4	09-1026B-9	NITRILE	50.8	2.00	12.7	0.50	22.0	0.87	673-0003	
9	F5	09-801B	NEOPRENE	57.1	2.25	15.9 KEY	0.63 / KEY	31.5	1.24	4568-0001	
10	F5	09-1027B-1	MC97	57.1	2.25	SPLINES		31.5	1.24	1210-0001	
10	F5	09-1027B-10	MC97	57.1	2.25	SPLINES		31.85	1.24		
10	F5	09-1027B-9	NITRILE	57.1	2.25	SPLINES		31.5	1.24	1210-0003	
11	F6	09-812B-1	MC97	57.1	2.25	SPLINES		48.2	1.90	13554-0001	
12	F7	09-1028BT-1	MC97	65	2.56	SPLINES		50.2	1.98	17937-0001	
12	F7	09-1028B-9	NITRILE	65	2.56	SPLINES		50.2	1.98	17937-0003	
13	F75	09-821BT-1	MC97	65	2.56	SPLINES		80	3.15		
14	F8	09-819B	NEOPRENE	95	3.74	SPLINES		63	2.48	836-0001	17935-0001
14	F8	09-819B-9	NITRILE	95	3.74	SPLINES		63	2.48	836-0003	17935-0003
16	F8	09-1029B <sup>1)</sup>	NEOPRENE	95	3.74	SPLINES		63	2.48	836-0001	17935-0001
15	F9	09-814B	NEOPRENE	95	3.74	SPLINES		88.5	3.48	21676-0001	17936-0001
15	F95	09-820B	NEOPRENE	95	3.74	SPLINES		130	5.12		
15	F98	09-842B	NEOPRENE	95	3.74	SPLINES		180	7.09		
16	F9	09-802B	NEOPRENE	95	3.74	SPLINES		88.5	3.48	6760-0001	

\* MC97 AND NEOPRENE - FOR COOLING, NITRILE - OIL RESISTANT

<sup>1)</sup> ALTERNATIVE IMPELLER 09-819B

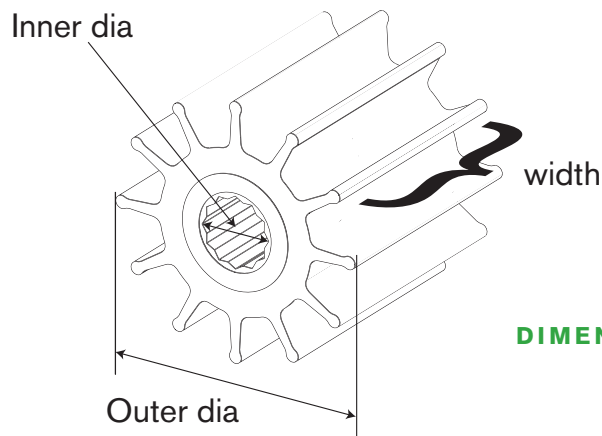

## DIMENSIONS SHERWOOD IMPELLERS

SHERWOOD/ MERCURISER JOHNSON PUMP IMPELLER						
	SHERWOOD 9959K	SHERWOOD 10615	MERCURISER 47-59362	SHERWOOD 17000K	SHERWOOD 18000K	
	09-701B-1	09-702B-1	09-703P-1	09-704BT-1	09-705BT-1	
OUTER DIAMETER	MM	62,3	65,4	66,7	84,1	94,5
	IN	2,45	2,57	2,63	3,31	3,72
WIDTH	MM	31,8	41,4	51	73,4	101,6
	IN	1,25	1,63	2,01	2,89	4

# Impeller Replacement Kits

SHERWOOD / MERCUISER / JABSCO

SCALE 1:1

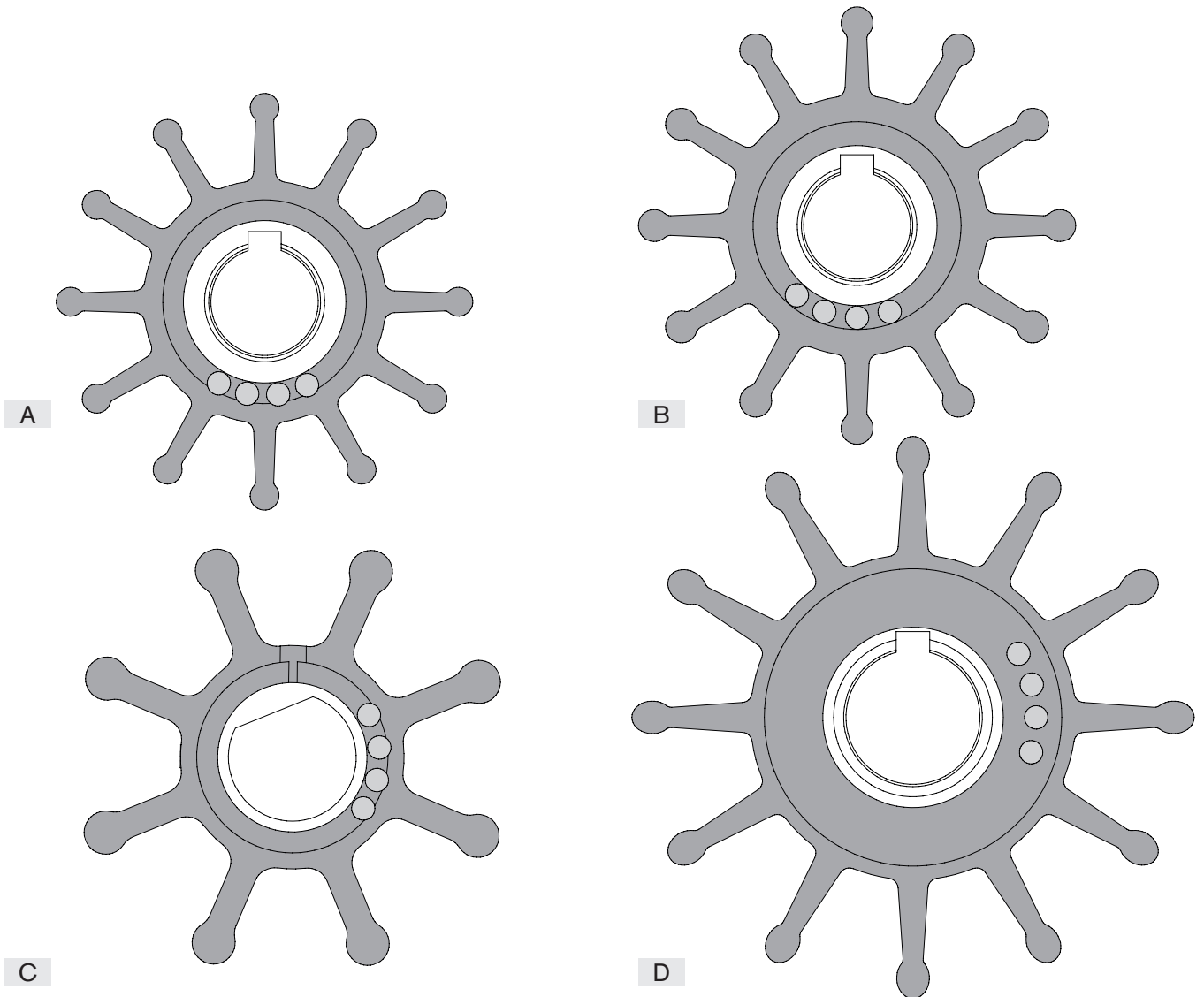

## IMPELLER REPLACEMENT KITS

REF.	SPX FLOW JOHNSON PUMP PART NO.	SHERWOOD PART NO.	MERCUISER PART NO.	JABSCO PART NO.	ENGINES / PUMPS
A	09-701B-1	9959K	-	18838-0001	CHRIS CRAFT; CHRYSLER MARINE; COMMANDER; CRUSADER; GLASTRON BOAT CO.; GRAY MARINE; INTERCEPTOR; ONAN; OMC; PATHFINDER VOLKSWAGON ENG.; PERKINS ENG. U.S.; PLESURECRAFT MARINE; UNIVERSAL MEDALIST; VOLVO PENTA; YAMAHA; WESTERBEKE 24102; SHERWOOD 11353; PLEASURE CRAFT 302&351; CHRIS CRAFT 350; ONAN MDL3,4
B	09-702B-1	10615K	-	18948-0001	CHRIS CRAFT; CHRYSLER MARINE; COMMANDER; CRUSADER; ESCORT (SKILTEC); GRAY MARINE; ISUZU; Lenco; MARINE POWER; NORTH AMERICAN ENGINE; ONAN; OSCO MOTORS; OMC; PERKINS ENGINE U.S.; PLESURECRAFT MARINE; VOLVO PENTA; J.H. WESTERBEKE CORP; CRUSADER 97179; CHRYSLER 3675763; CHRYSLER 4142878; CUMMINS 4B; ONAN MDL6; CHRIS CRAFT 454; PLEASURE CRAFT 454
C	09-703P-1	-	47-59362T	17954-0001	PUMP QUICKSILVER MODEL 46-72774 A32
D	09-704BT-1	17000K	-	18958-0001	CUMMINS 6B 300HP B SERIES; CUMMINS C SERIES; CAT 3208; CAT 3116; CAT 3126; DEERE 6076; SHERWOOD PUMP P17 SERIES

# Impeller Replacement Kits

# SPXFLOW

for engine water cooling pumps  
Johnson Pump  
Sherwood / Mercruiser / Jabsco

## Customer Service & Support - Johnson Pump Marine

**SE** +46 19 21 83 10  
johnson-pump.marine@spxflow.com

**US** +1 847 671-7867  
jp-customerservice@spxflow.com

**AUS** +61 03 9589 9222  
ft.aus.cs@spxflow.com

**> Johnson  
Pump®**

For more information about our worldwide locations, approvals, certifications, and local representatives, visit Johnson Pump - Marine at [www.spxflow.com](http://www.spxflow.com)

---

SPX FLOW, Inc. reserves the right to incorporate our latest design and material changes without notice or obligation.

Design features, materials of construction and dimensional data, as described in this bulletin, are provided for your information only and should not be relied upon unless confirmed in writing. Please contact your local sales representative for product availability in your region. For more information visit [www.spxflow.com](http://www.spxflow.com).  
The green ">" and "X" are trademarks of SPX FLOW, Inc.

---