



# **Auto Glide™**

## **Boat Control System**

### **Owner's Manual B**

# **Operational Instructions**

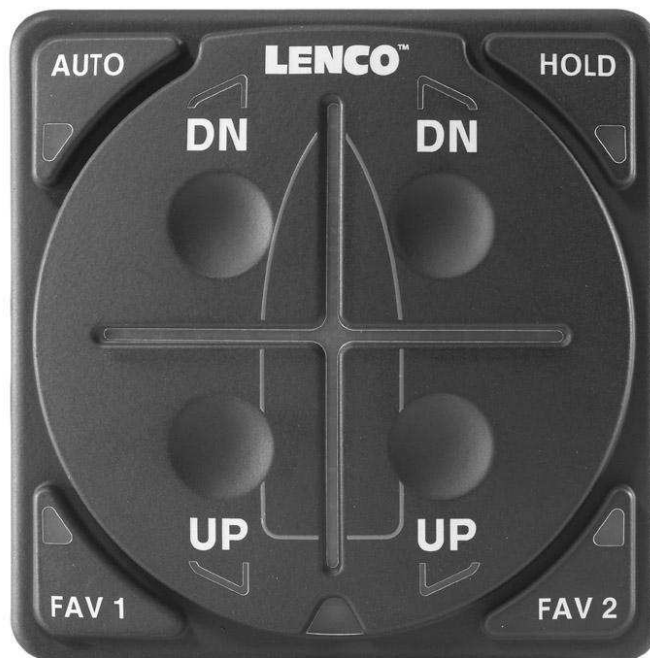

Please visit our website to view up-to-date information and various videos which may be beneficial to you. [www.lencoautoglide.com](http://www.lencoautoglide.com)

# **AUTO GLIDE OPERATION INSTRUCTIONS**

Once the **Home Roll Default Position** and **Home Pitch Default Position** have been saved, the Auto Glide can provide you with full automatic boat control. This section describes how to operate the Auto Glide in both **AUTOMATIC and MANUAL MODES**.

Here is the list of topics we will cover in this section:

<b>I.</b>	<b><u>KEY PAD OVERVIEW</u></b> .....	<b>3 - 5</b>
	<b>A. KEY PAD BUTTONS</b> .....	<b>3</b>
	<b>B. KEY PAD BUTTON LED INDICATORS</b> .....	<b>3</b>
	<b>C. CROSSHAIR LED INDICATORS</b> .....	<b>4 - 5</b>
<b>II.</b>	<b><u>AUTOMATIC OPERATIONAL MODES</u></b> .....	<b>6 - 22</b>
	<b>A. IDLE MODE</b> .....	<b>6 - 8</b>
	1. ENTERING IDLE MODE .....	<b>6 - 7</b>
	2. EXITING IDLE MODE INTO HOLE SHOT MODE.....	<b>8</b>
	<b>B. HOLE SHOT MODE</b> .....	<b>9 - 14</b>
	1. TRIM TABS AUTO-RETRACT IN REVERSE BOAT EQUIPPED WITH DIGITAL SHIFT.....	<b>10</b>
	2. SMOOTH WATER CONDITIONS: TRANSITION - HOLE SHOT TO PLANING MODE.....	<b>11</b>
	3. ROUGH WATER HOLE SHOT.....	<b>12</b>
	4. ROUGH WATER CONDITIONS: TRANSITION - HOLE SHOT TO PLANING MODE.....	<b>13</b>
	5. OVERRIDING ROUGH WATER HOLE SHOT MODE.....	<b>14</b>
	<b>C. PLANING MODE</b> .....	<b>15 - 22</b>
	1. ROLL CORRECTION.....	<b>16 - 17</b>
	2. PITCH CORRECTION.....	<b>18 - 19</b>
	3. YAW LOCK OUT.....	<b>20</b>
	4. RAPID DECELERATION.....	<b>21</b>
	5. EXITING PLANING MODE.....	<b>22</b>
<b>III.</b>	<b><u>AUTOMATIC SETTINGS</u></b> .....	<b>23 - 26</b>
	<b>A. AUTO SETTING</b> .....	<b>23 - 24</b>
	<b>B. FAV 1, FAV 2, and HOLD SETTINGS</b> .....	<b>24 - 26</b>
	1. SAVING “FAV 1” and “FAV 2” HOME ROLL AND PITCH POSITIONS.....	<b>24 - 25</b>
	2. RESETTING “FAV 1” AND “FAV 2” HOME ROLL AND PITCH POSITIONS.....	<b>25</b>
	3. SAVING “HOLD” HOME ROLL AND PITCH POSITIONS.....	<b>26</b>
<b>IV.</b>	<b><u>MANUAL OPERATION MODES</u></b> .....	<b>27 - 32</b>
	<b>A. MANUAL MODE</b> .....	<b>27 - 29</b>
	1. EXITING MANUAL MODE.....	<b>29</b>
	<b>B. LIMP HOME MODE</b> .....	<b>29 - 32</b>
<b>V.</b>	<b><u>SYSTEM FAILURE WARNING MESSAGES</u></b> .....	<b>33 - 38</b>
	<b>A. DATA LOSS FAILURE</b> .....	<b>33</b>
	<b>B. GPS DATA LOSS</b> .....	<b>33</b>
	<b>C. ENGINE DATA LOSS</b> .....	<b>34</b>
	<b>D. KEY PAD COMMUNICATION LOSS</b> .....	<b>35</b>
	<b>E. REACQUIRED DATA LOSS</b> .....	<b>36</b>
	<b>F. ACTUATOR OVER-AMPERAGE</b> .....	<b>37 - 38</b>
	<b>G. CONTROL BOX OUT OF OPERATIONAL TOLERANCE</b> .....	<b>38</b>

## I. KEY PAD OVERVIEW

### A. KEY PAD BUTTONS

The Auto Glide Key Pad has two (2) Bow Down and two (2) Bow Up buttons that provide manual control of the trim tabs at any time. There are also four (4) Automatic Setting Buttons on the outer corners of the key pad that enable you to select up to four different automatic Home Roll and Pitch positions that the Auto Glide will use to level the boat.

#### KEY PAD - BUTTON OVERVIEW

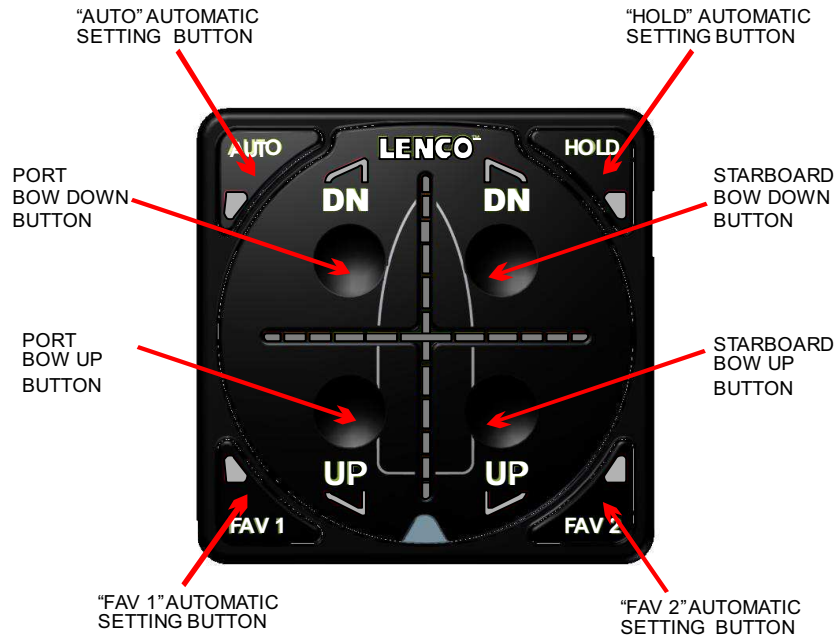

### B. KEY PAD BUTTON LED INDICATORS

Each of the Key Pad Buttons also has a corresponding LED Indicator that illuminates to indicate that the button is being activated (either manually or automatically).

#### KEY PAD - LED INDICATOR OVERVIEW

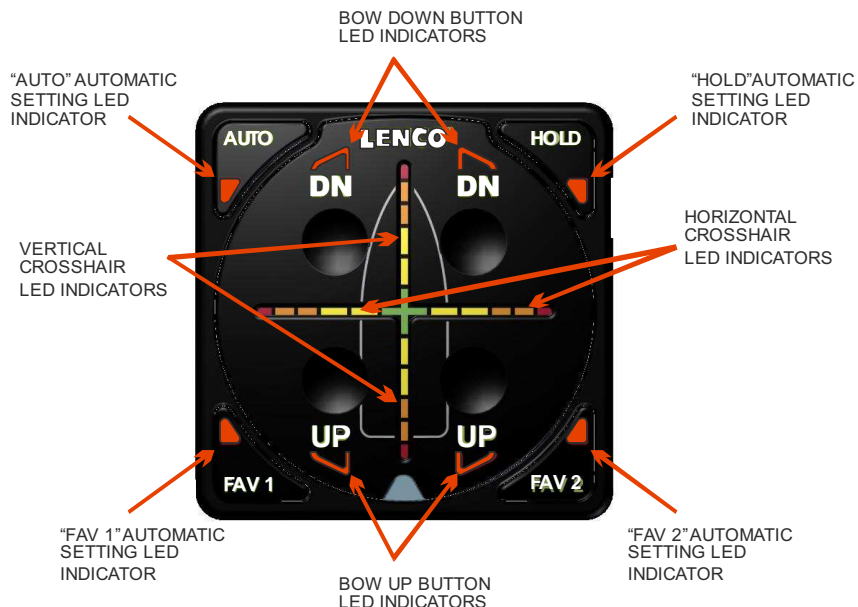

### C. CROSSHAIR LED INDICATORS

The Crosshair LED Indicators are constantly showing the boat's **CURRENT ROLL AND PITCH POSITIONS** compared to the **HOME ROLL AND PITCH POSITION**. As the boat rocks back and forth on the water, the Auto Glide is constantly tracking the boat's position and displaying it on the crosshairs. Roll and Pitch Positions are illuminated independently of each other on the Horizontal and Vertical Crosshairs.

The Auto Glide is constantly measuring the boat's **CURRENT ROLL AND PITCH POSITIONS** at the rate of 25 times per second. However, that information is dampened so that the Auto Glide does not overreact to every small movement of the boat. You will most likely notice the dampening because the **CURRENT ROLL AND PITCH POSITIONS** are displayed on the Key Pad slower than the boat is actually moving.

The following examples illustrate how the boat's **CURRENT ROLL AND PITCH POSITIONS** are shown to you on the Key Pad's Crosshair LED Indicators:

#### **EXAMPLE #1: THE BOAT CURRENT ROLL AND PITCH POSITIONS MATCH THE AUTO GLIDE'S HOME ROLL AND PITCH DEFAULT POSITIONS:**

VERTICAL LEDS ON THE CROSSHAIR SHOW YOU THE **CURRENT PITCH POSITION** OF YOUR BOAT IN REFERENCE TO THE AUTO GLIDE'S **HOME ROLL DEFAULT POSITION**



HORIZONTAL LEDS ON THE CROSSHAIR SHOW YOU THE **CURRENT ROLL POSITION** OF YOUR BOAT IN REFERENCE TO THE AUTO GLIDE'S **HOME ROLL DEFAULT POSITION**

**EXAMPLE:** THE BOAT'S **CURRENT ROLL POSITION** MATCHES THE AUTO GLIDE'S **HOME ROLL DEFAULT POSITION** AND THE BOAT'S **CURRENT PITCH POSITION** MATCHES THE AUTO GLIDE'S **HOME PITCH DEFAULT POSITION**. THEREFORE, THE CENTER "GREEN" CROSSHAIR LED WILL BE ILLUMINATED.

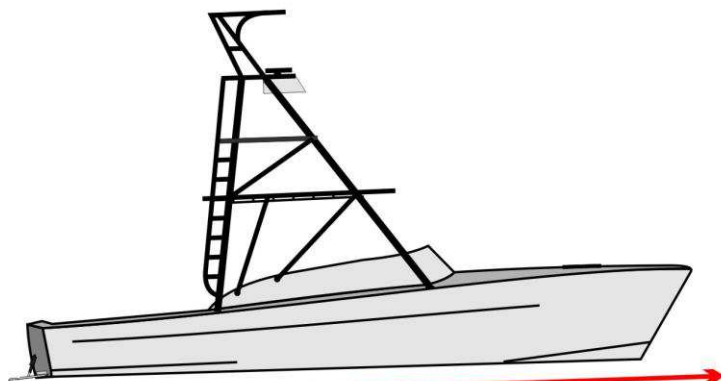

CURRENT PITCH POSITION MATCHES AUTO GLIDE'S HOME PITCH DEFAULT POSITION

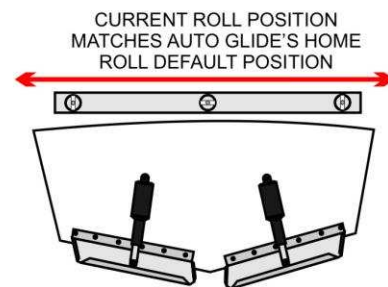

CURRENT ROLL POSITION MATCHES AUTO GLIDE'S HOME ROLL DEFAULT POSITION

**EXAMPLE #2: THE CURRENT ROLL POSITION IS ROLLED TO PORT, BUT THE CURRENT PITCH POSITION MATCHES THE AUTO GLIDE'S HOME PITCH DEFAULT POSITION.**

THE HORIZONTAL LEDS ON THE CROSSHAIR SHOW YOU THAT THE **CURRENT ROLL POSITION** OF YOUR BOAT IS ROLLED TO THE PORT IN REFERENCE TO THE AUTO GLIDE'S **HOME ROLL DEFAULT POSITION**.



VERTICAL LEDS ON THE CROSSHAIR SHOW YOU THAT THE **CURRENT PITCH POSITION** OF YOUR BOAT STILL MATCHES THE AUTO GLIDE'S **HOME PITCH DEFAULT POSITION**.

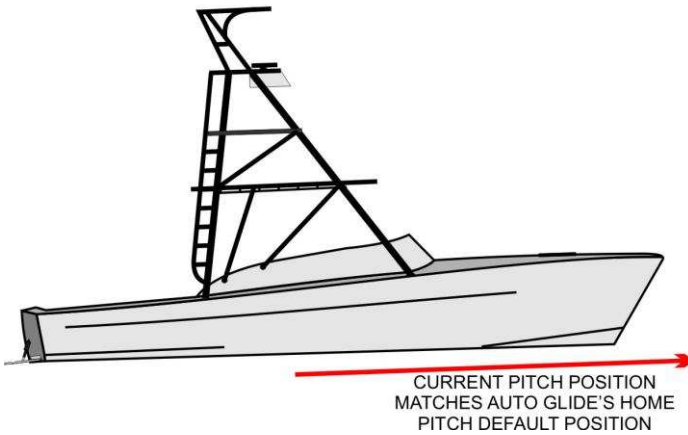

CURRENT ROLL POSITION IS ROLLED TO PORT OF THE AUTO GLIDE'S HOME ROLL DEFAULT POSITION

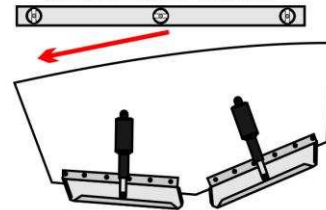

**EXAMPLE #3: THE CURRENT ROLL POSITION IS ROLLED TO STARBOARD AND THE CURRENT PITCH POSITION IS ABOVE THE HOME PITCH DEFAULT POSITION.**

THE VERTICAL LEDS ON THE CROSSHAIR SHOW YOU THAT THE **CURRENT PITCH POSITION** OF YOUR BOAT IS ABOVE THE AUTO GLIDE'S **HOME PITCH DEFAULT POSITION**.



HORIZONTAL LEDS ON THE CROSSHAIR SHOW YOU THAT THE **CURRENT ROLL POSITION** OF YOUR BOAT IS ROLLED TO STARBOARD IN REFERENCE TO THE AUTO GLIDE'S **HOME ROLL DEFAULT POSITION**.

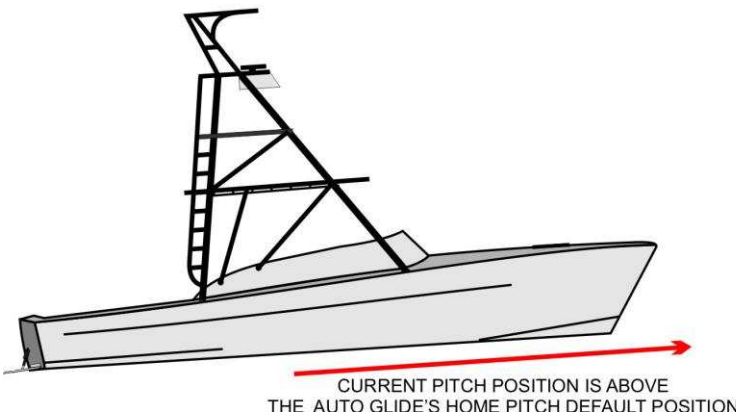

CURRENT ROLL POSITION IS ROLLED TO STARBOARD OF THE AUTO GLIDE'S HOME ROLL DEFAULT POSITION

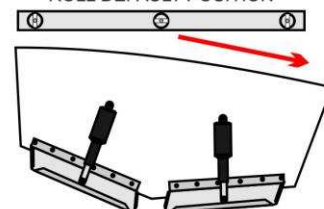

## II. AUTOMATIC OPERATIONAL MODES

There are three (3) AUTOMATIC OPERATIONAL MODES that the Auto Glide uses to make all of the automatic boat control decisions. These AUTOMATIC OPERATIONAL MODES are:

- A. IDLE MODE
- B. HOLE SHOT MODE
- C. PLANING MODE

These three AUTOMATIC OPERATIONAL MODES use the Engine and GPS CANBUS DATA plus the HOME ROLL AND PITCH POSITIONS to decide how and when to move the trim tabs to correct the position of the boat.

### A. IDLE MODE:

The primary objective of IDLE MODE is to limit the movement of the trim tabs during idle conditions which would include situations such as maneuvering the boat within a marina or boat launch area.

1. ENTERING IDLE MODE: The Auto Glide will transition into IDLE MODE when the boat's motor(s) is started and the Auto Glide sees 400 RPMs or greater from the CANBUS data. The AUTO SETTING button will illuminate on the Key Pad to indicate the Auto Glide is in an automatic mode.

The following illustrations outline the sequence of LED indicator flashes as the Auto Glide transitions into IDLE MODE when you start the motor(s).

#### LED SEQUENCE IMMEDIATELY FOLLOWING MOTOR(S) STARTUP



ALL FOUR (4) AUTOMATIC SETTING INDICATORS AND ALL FOUR (4) UP/DN INDICATORS FLASH BRIEFLY.

THE CROSSHAIR LED INDICATORS ALSO CONVERGE TO THE CENTER IMMEDIATELY FOLLOWING MOTOR(S) STARTUP.

### AUTO-RETRACTION AFTER MOTOR(S) STARTUP



BOTH UP ACTUATOR LED INDICATORS FLASH AS THE AUTO GLIDE RETRACTS THE TRIM TAB ACTUATORS TO ENSURE THE TRIM TABS ARE FULLY RETRACTED.

**NOTE:** THE AUTO GLIDE ONLY RETRACTS THE TRIM TABS IF IT IS THE FIRST TIME YOU STARTED THE MOTOR(S) SINCE TURNING "ON" THE BATTERY SWITCH OR YOU WERE IN MANUAL MODE THE LAST TIME YOU TURNED OFF THE MOTOR(S).

**NOTE:**  
If it is the first time you have started your motor(s) since turning "ON" your battery switch, the Auto Glide will auto-retract the trim tabs to ensure they are fully retracted. The Auto Glide will also auto-retract the trim tabs if you were in MANUAL MODE the last time you turned OFF your motor(s).

Once the Auto Glide "wakes up", it takes a few moments to verify that it is receiving all of the required ENGINE and GPS DATA and that both HOME ROLL AND PITCH DEFAULT POSITIONS have been stored. It then defaults to the "AUTO" AUTOMATIC SETTING and IDLE MODE.

### DEFAULTS TO "AUTO" AUTOMATIC SETTING AND IDLE MODE



THE "AUTO" AUTOMATIC SETTING LED INDICATOR ILLUMINATES ONCE THE AUTO GLIDE HAS VERIFIED IT HAS ALL OF THE REQUIRED ENGINE AND GPS DATA PLUS THE HOME ROLL AND PITCH DEFAULT POSITIONS HAVE BEEN STORED.

**NOTE:** WHILE IN THE "AUTO" AUTOMATIC SETTING, THE AUTO GLIDE WILL CONTINUE TO DISPLAY THE CURRENT ROLL AND PITCH POSITIONS OF THE BOAT COMPARED TO HOME ROLL AND PITCH POSITIONS.

HOWEVER, IT WILL NOT MAKE ANY ATTEMPTS TO CORRECT ROLL AND PITCH POSITIONS WHILE THE BOAT IS IN IDLE MODE.

2. **EXITING IDLE MODE INTO HOLE SHOT MODE:** The Auto Glide will not extend or retract the trim tabs while you are in **IDLE MODE**. If you are maneuvering around the dock or boat launch area, the trim tabs remain retracted until you **EXIT IDLE MODE** by:
- **Going faster than 4 MPH:**

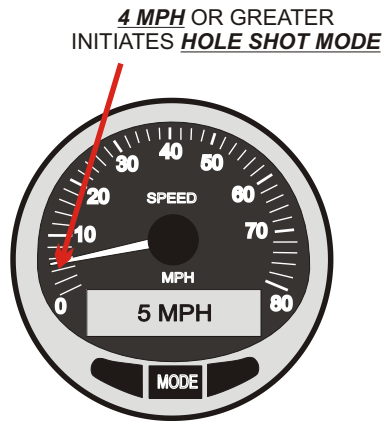

- **Override IDLE MODE by pressing the currently selected AUTOMATIC SETTING BUTTON (i.e. AUTO, FAV 1, FAV 2, HOLD):**



PRESS WHICHEVER OF THE FOUR (4) **AUTOMATIC SETTING BUTTONS** (IN THIS EXAMPLE YOU PRESS THE **AUTO BUTTON**) AND THE AUTO GLIDE WILL OVERRIDE **IDLE MODE** AND TRANSITION DIRECTLY INTO **HOLE SHOT MODE**.

THIS ALLOWS YOU TO IMMEDIATELY TRANSITION INTO **HOLE SHOT MODE** FROM A DEAD STOP.



**B. HOLE SHOT MODE:**

The objective of **HOLE SHOT MODE** is to provide the fastest and most efficient transition from *HOLE SHOT* to *ON PLANE* by automatically deploying the trim tabs before acceleration and automatically retracting the trim tabs as the boat reaches cruising speed and the **CURRENT PITCH POSITION** approaches the saved **HOME PITCH DEFAULT POSITION**.

**ENTERING HOLE SHOT MODE:** Once the boat enters into **HOLE SHOT MODE**, the Auto Glide automatically fully deploys the trim tabs in preparation for Hole Shot.

**HOLE SHOT MODE - FULLY EXTEND TRIM TABS**



AS SOON AS THE AUTO GLIDE ENTERS INTO **HOLE SHOT MODE**, IT FULLY DEPLOYS THE TRIM TABS UNLESS THE SEA CONDITIONS ARE TOO ROUGH. **ROUGH WATER HOLE SHOT** IS COVERED ON PAGE 12.

**NOTE:** THE AUTO GLIDE DOES NOT REACT TO **CURRENT ROLL AND PITCH POSITION** UNTIL THE BOAT IS IN **PLANING MODE**. HOWEVER, THE CROSSHAIR LED INDICATORS CONTINUE TO DISPLAY THE POSITION OF THE BOAT WHILE IN **HOLE SHOT MODE**.

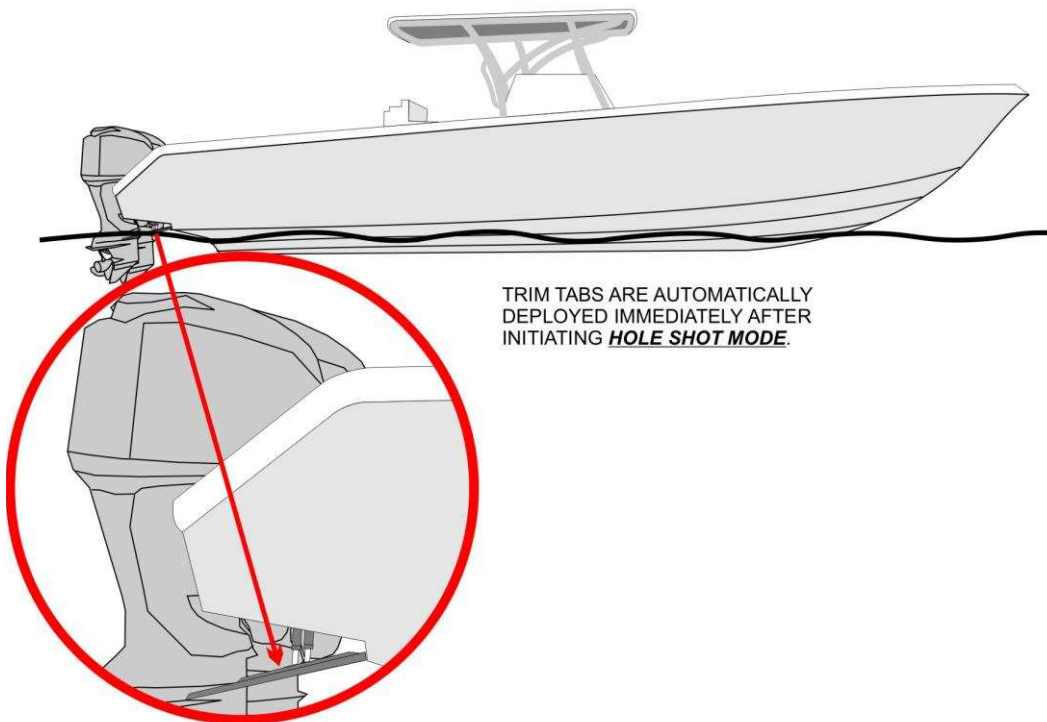

TRIM TABS ARE AUTOMATICALLY DEPLOYED IMMEDIATELY AFTER INITIATING **HOLE SHOT MODE**.

1. **TRIM TABS AUTO-RETRACT IN REVERSE IF BOAT IS EQUIPPED WITH DIGITAL SHIFT**

**SYSTEM:** If the boat has Mercury DTS Engine Shift or NMEA 2000 Engine Shift Systems, the Auto Glide will retract the trim tabs when you shift your motor(s) into reverse. This only occurs while the Auto Glide is in HOLE SHOT MODE. This feature is not available on boats that do not have Mercury DTS or NMEA 2000 Engine Shift data available on the CANBUS.

**TRIM TABS AUTO-RETRACT IN REVERSE IF BOAT IS EQUIPPED WITH DIGITAL SHIFT SYSTEM**

**BOATS WITH MERCURY DTS OR  
NMEA 2000 DIGITAL SHIFT SYSTEM**



IF YOUR BOAT HAS MERCURY DTS DIGITAL SHIFT OR NMEA 2000 DIGITAL SHIFT SYSTEMS, THE AUTO GLIDE **FULLY RETRACTS THE TRIM TABS** WHEN YOU SHIFT INTO REVERSE WHILE THE AUTO GLIDE IS IN **HOLE SHOT MODE**.

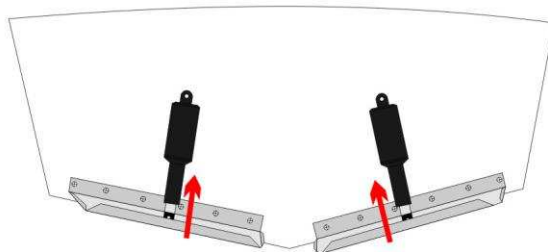
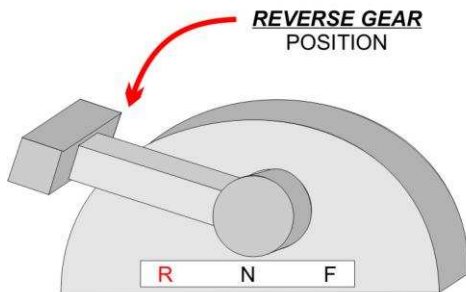

2. **SMOOTH WATER CONDITIONS: TRANSITION FROM HOLE SHOT MODE TO PLANING**

**MODE:** After deploying the trim tabs, the Auto Glide monitors the boat's GPS speed in preparation for the transition from **HOLE SHOT MODE** into **PLANING MODE**. As soon as the boat passes 12 MPH and the boat's pitch angle begins to decrease, the Auto Glide begins to retract the trim tabs as the boat approaches the **HOME PITCH DEFAULT POSITION**.

**TRANSITION FROM HOLE SHOT MODE TO PLANING MODE**

BOAT MUST BE GOING FASTER THAN 12 MPH TO BEGIN TRANSITION TO **PLANING MODE**.

TRIM TABS RETRACT IN SHORT BURSTS AS PITCH ANGLE DROPS CLOSER TO **HOME PITCH DEFAULT POSITION**.

AUTO GLIDE TRANSITIONS TO **PLANING MODE** WHEN THE BOAT'S PITCH ANGLE REACHES THE **HOME PITCH DEFAULT POSITION**.

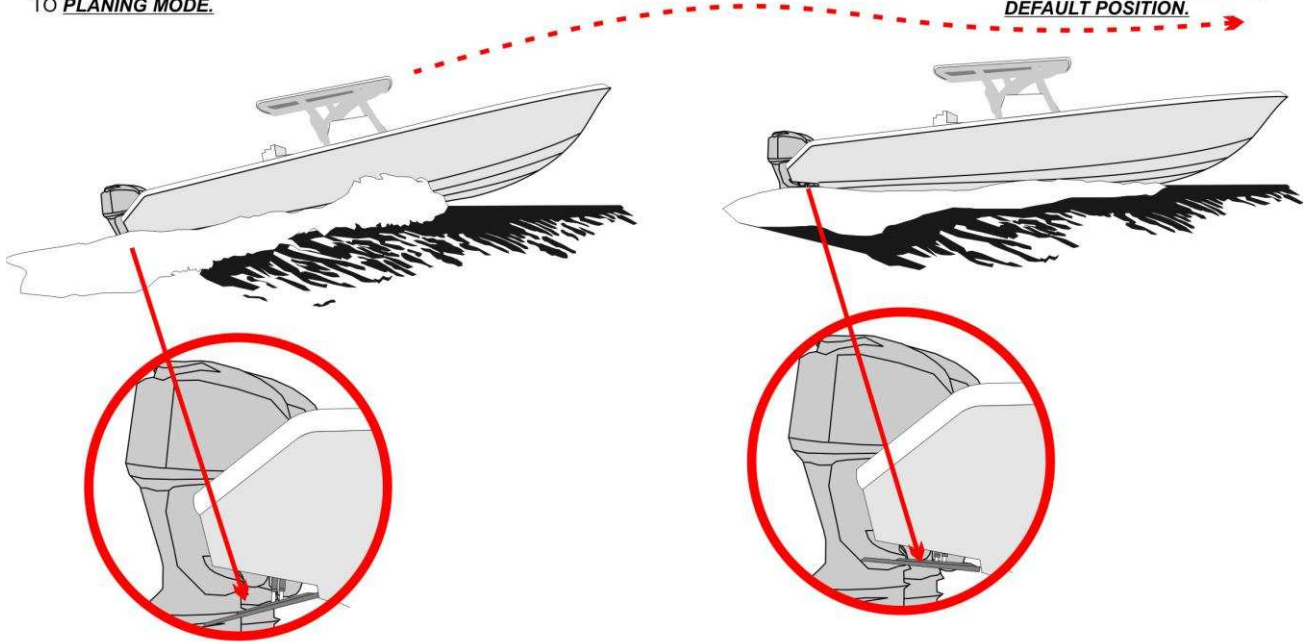

TRIM TABS ARE FULLY DEPLOYED AS BOAT ACCELERATES THRU 12 MPH

TRIM TABS CONTINUE TO RETRACT IN HOLE SHOT MODE UNTIL THE BOAT'S CURRENT PITCH POSITION REACHES THE HOME PITCH DEFAULT POSITION.

**NOTE:** THE AUTO GLIDE WILL NOT CORRECT FOR ROLL WHILE IT IS IN **HOLE SHOT MODE**. ROLL CORRECTIONS ARE MADE ONCE THE BOAT REACHES ITS **HOME PITCH DEFAULT POSITION** AND THE AUTO GLIDE TRANSITIONS TO **PLANING MODE**.



THE TRIM TABS CONTINUE TO RETRACT IN SHORT BURSTS AS THE BOAT'S **CURRENT PITCH POSITION** REACHES THE **HOME PITCH DEFAULT POSITION**.

**NOTE:**  
**THE AUTO GLIDE WILL NOT CORRECT FOR ROLL WHILE IT IS IN HOLE SHOT MODE. ROLL CORRECTIONS ARE MADE ONCE THE BOAT REACHES ITS HOME PITCH DEFAULT POSITION AND THE AUTO GLIDE TRANSITIONS TO PLANING MODE.**

3. **ROUGH WATER HOLE SHOT:** The Auto Glide is constantly measuring sea conditions. If it senses rough seas while in **HOLE SHOT MODE**, the Auto Glide will fully retract the trim tabs to minimize the chances of pushing the boat's bow under a wave while you are attempting to get on plane in rough seas.

**HOLE SHOT MODE - ROUGH SEAS - FULLY RETRACT TRIM TABS**



THE AUTO GLIDE FULLY RETRACTS THE TRIM TABS AND DEFAULTS TO **ROUGH WATER HOLE SHOT MODE** IF IT SENSES ROUGH SEA CONDITIONS WHILE IN **HOLE SHOT MODE**.

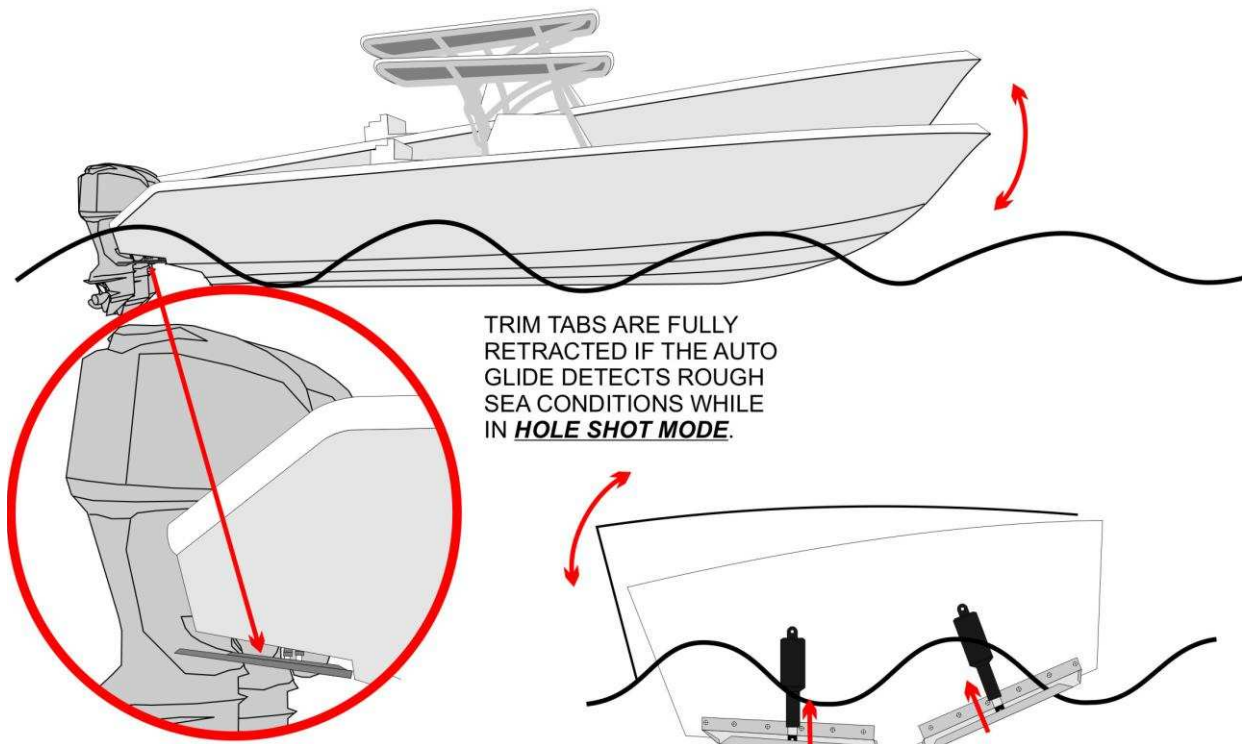

TRIM TABS ARE FULLY RETRACTED IF THE AUTO GLIDE DETECTS ROUGH SEA CONDITIONS WHILE IN **HOLE SHOT MODE**.

**NOTE:**  
**THE AUTO GLIDE CONTINUES TO MONITOR SEA CONDITIONS EVEN AFTER DETECTING ROUGH SEAS AND RETRACTING THE TRIM TABS. IF THE AUTO GLIDE DETECTS THAT THE SEA CONDITIONS HAVE SMOOTHED OUT AFTER 15 SECONDS, THE TABS ARE RE-DEPLOYED AND THE AUTO GLIDE DEFAULTS BACK TO NORMAL HOLE SHOT MODE. THIS HELPS REDUCE THE EFFECTS OF PASSING THRU LARGE BOAT WAKES AND FALSELY DETECTING ROUGH SEA CONDITIONS.**

4. **ROUGH WATER CONDITIONS: TRANSITION FROM ROUGH WATER HOLE SHOT MODE TO PLANING MODE:** After retracting the trim tabs, the Auto Glide monitors the boat's GPS speed and pitch angle in preparation for the transition from **ROUGH WATER HOLE SHOT MODE** to **PLANING MODE**. In most rough water conditions, it takes longer to get on plane than it does in smooth water conditions. Sometimes the conditions are so rough that the boat might not ever get on plane.

In **ROUGH WATER HOLE SHOT MODE**, the Auto Glide will begin to make automatic corrections to changes in roll angle after the boat is going faster than 12 MPH, but has still not transitioned to **PLANING MODE**. However, no automatic pitch corrections will be made until the boat's **CURRENT PITCH POSITION** reaches the Auto Glide's **HOME PITCH DEFAULT POSITION** and transitions to **PLANING MODE**.

**TRANSITION FROM ROUGH WATER HOLE SHOT MODE TO PLANING MODE**

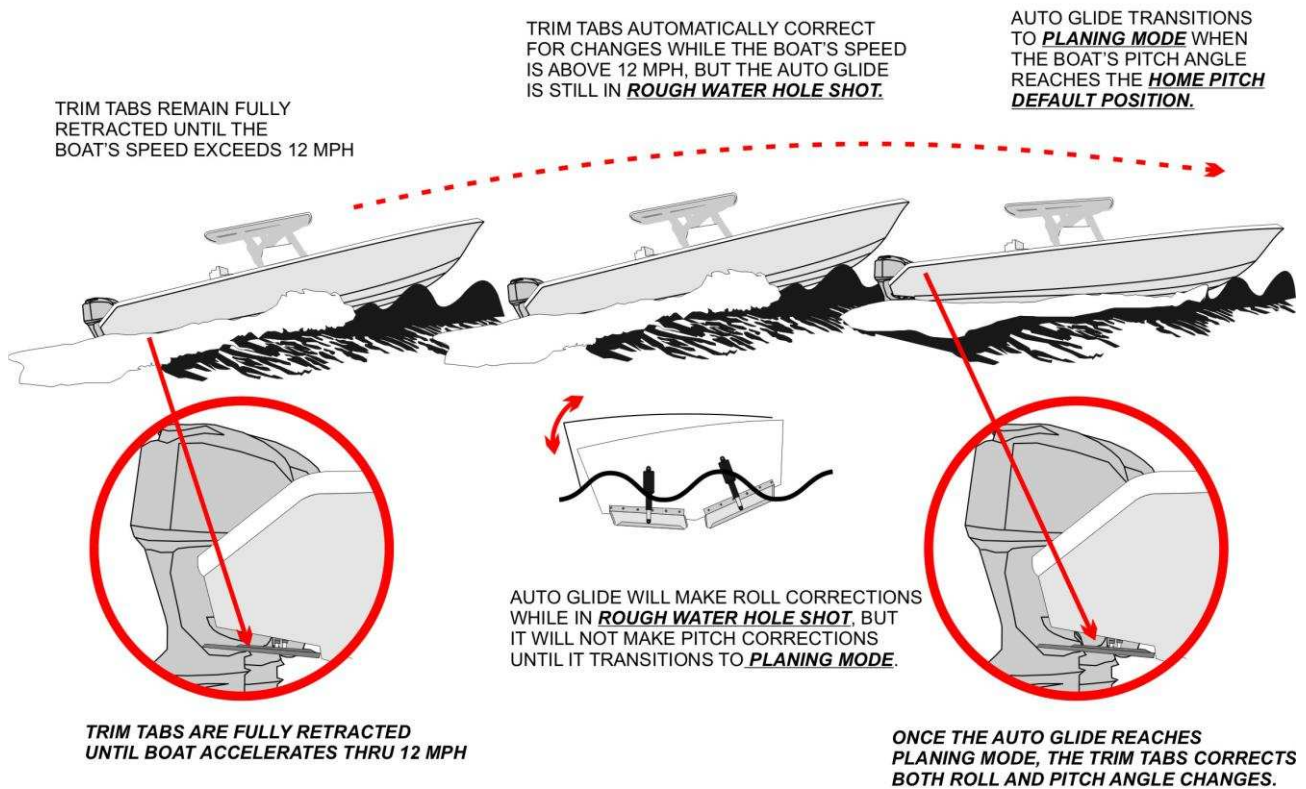

**NOTE:** THE AUTO GLIDE **WILL MAKE ROLL CORRECTIONS** WHILE IT IS IN **ROUGH WATER HOLE SHOT MODE**. PITCH CORRECTIONS ARE MADE ONCE THE AUTO GLIDE TRANSITIONS TO **PLANING MODE**.



THE AUTO GLIDE WILL MAKE ROLL CORRECTIONS WITH THE TRIM TABS ONCE THE BOAT IS GOING FASTER THAN 12 MPH. IT WILL NOT MAKE PITCH CORRECTIONS UNTIL THE BOAT'S **CURRENT PITCH POSITION** REACHES THE **HOME PITCH DEFAULT POSITION** AND THE AUTO GLIDE TRANSITIONS TO **PLANING MODE**.

5. **OVERRIDING ROUGH WATER HOLE SHOT MODE:** In the event you are in rough water, but still want the Auto Glide to assist the boat getting on plane you can **OVERVERRIDE ROUGH WATER HOLE SHOT MODE** by pressing the selected (lighted) **AUTOMATIC SETTING BUTTON**. This is the button in which you are currently operating. This could be any of the four (4) **AUTOMATIC SETTING BUTTONS**. Once you press this **AUTOMATIC SETTING BUTTON**, the trim tabs will fully deploy and the Auto Glide will default to normal **HOLE SHOT MODE**.

**WARNING**  
**IF YOU OVERRIDE ROUGH WATER HOLE SHOT, YOU ARE ASSUMING FULL RESPONSIBILITY FOR THE EFFECTS OF HOLE SHOT TRANSITION IN ROUGH SEA CONDITIONS.**

**HOLE SHOT MODE - OVERRIDE ROUGH SEAS - FULLY EXTEND TRIM TABS**



PRESS THE SELECTED AUTO BUTTON TO OVER-RIDE **ROUGH WATER HOLE SHOT MODE**. THE AUTO GLIDE **FULLY DEPLOYS THE TRIM TABS**, EVEN THOUGH IT SENSES ROUGH SEA CONDITIONS.

**WARNING: IF YOU OVERRIDE THE AUTOMATIC RETRACTION OF TRIM TABS IN ROUGH WATER CONDITIONS, YOU ARE ASSUMING FULL RESPONSIBILITY FOR THE EFFECTS OF THE HOLE SHOT TRANSITION.**

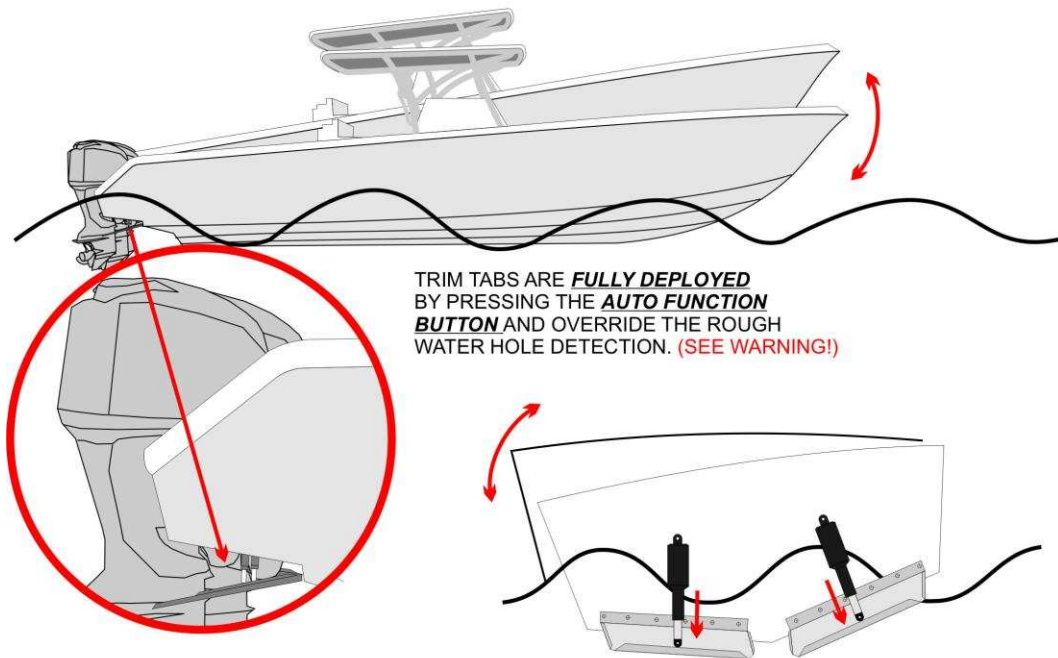

TRIM TABS ARE **FULLY DEPLOYED** BY PRESSING THE **AUTO FUNCTION BUTTON** AND OVERRIDE THE ROUGH WATER HOLE DETECTION. (SEE WARNING!)

**WARNING**  
**IF YOU OVERRIDE ROUGH WATER HOLE SHOT, YOU ARE ASSUMING FULL RESPONSIBILITY FOR THE EFFECTS OF HOLE SHOT TRANSITION IN ROUGH SEA CONDITIONS.**

**C. PLANING MODE:**

The objective of **PLANING MODE** is to automatically detect and correct Roll and Pitch angle changes to maintain the most economical, smooth and level ride for the boat.

The Auto Glide transitions from **HOLE SHOT MODE** into **PLANING MODE** as soon as the boat reaches the **HOME PITCH DEFAULT POSITION**. During **PLANING MODE**, the Auto Glide monitors Roll and Pitch changes and automatically moves the trim tabs to correct for those changes. The **CURRENT ROLL AND PITCH POSITIONS** are constantly displayed on the Key Pad Crosshair LED Indicators.

The following illustrations outline how the Auto Glide corrects for Roll and Pitch angle changes and how these changes are displayed on the Key Pad Crosshair LED Indicator.

**EXAMPLE 1: BOAT'S CURRENT ROLL AND PITCH POSITIONS MATCH THE AUTO GLIDE'S HOME ROLL AND PITCH DEFAULT POSITIONS:**

Only the green center LEDs are illuminated on the Crosshair LED Indicators when the boat's **CURRENT ROLL AND PITCH POSITIONS** match the Auto Glide's **HOME ROLL AND PITCH DEFAULT POSITIONS**.

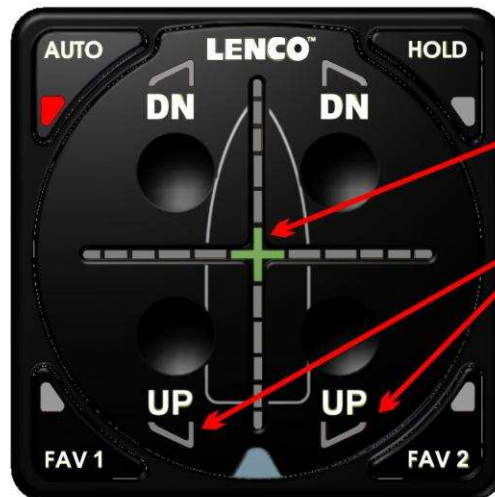
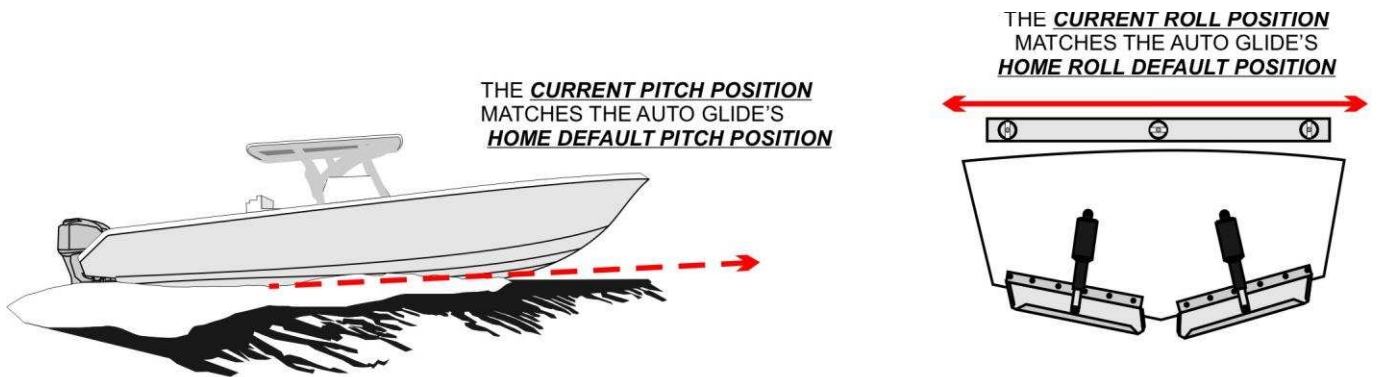

WHEN YOUR BOAT'S **CURRENT ROLL AND PITCH POSITIONS** MATCH THE AUTO GLIDE'S **HOME ROLL AND PITCH DEFAULT POSITIONS**, ONLY THE GREEN CENTER LED IS ILLUMINATED ON THE CROSSHAIR LED INDICATORS.

THE AUTO GLIDE DOES NOT MOVE THE TRIM TABS WHEN THE BOAT'S **CURRENT ROLL AND PITCH POSITIONS** MATCH THE SAVED **HOME ROLL AND PITCH DEFAULT POSITIONS**.

**NOTE:**  
**THIS EXAMPLE ILLUSTRATES THE KEY PAD LED INDICATORS DISPLAY WHEN THE BOAT'S ROLL AND PITCH POSITIONS ARE EQUAL TO THE HOME DEFAULT POSITIONS WHICH WERE ESTABLISHED DURING SETUP MODE.**

1. **ROLL CORRECTION:**

The following two examples will explain how the Auto Glide makes roll angle corrections while in **PLANING MODE.**

**EXAMPLE 2A: BOAT'S CURRENT ROLL POSITION IS ROLLED TO PORT, BUT CURRENT PITCH MATCHES THE AUTO GLIDE'S HOME PITCH.**

When the boat's **CURRENT ROLL POSITION** has rolled to port side, but your **CURRENT PITCH POSITION** still matches the Auto Glide's **HOME PITCH DEFAULT POSITION**, the Horizontal Crosshair LED Indicator will display how far the boat has rolled away from the **HOME ROLL DEFAULT POSITION.**

However, the green center LED will remain illuminated to indicate that the **CURRENT HOME PITCH POSITION** still matches Auto Glide's **HOME PITCH DEFAULT POSITION.**

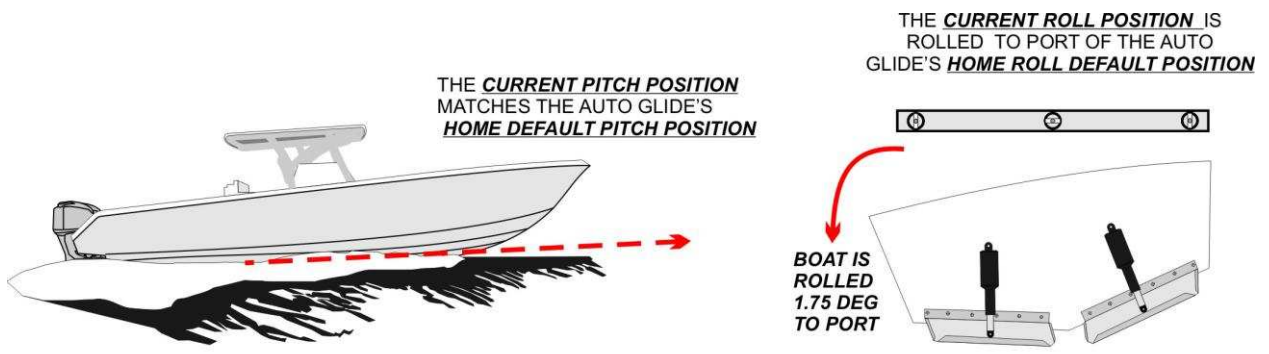

THE 2ND LED ON THE PORT SIDE OF THE HORIZONTAL CROSSHAIR LED INDICATOR IS ILLUMINATED TO INDICATE THAT THE BOAT'S **CURRENT ROLL POSITION** IS ROLLED TO THE PORT OF THE AUTO GLIDE'S **HOME ROLL DEFAULT POSITION.**

**NOTE:** EACH LED ON THE HORIZONTAL CROSS HAIR LED INDICATOR INDICATES THE BOAT HAS ROLLED 7/8 DEGREES AWAY FROM THE **HOME ROLL DEFAULT POSITION.**

IN THIS EXAMPLE, THE BOAT HAS ROLL 2 LEDS = 1.75 DEGREES TO PORT FROM THE **HOME ROLL DEFAULT POSITION.**



THE GREEN CENTER LED REMAINS ILLUMINATE TO INDICATE THAT THE BOAT'S **CURRENT PITCH POSITION** STILL MATCHES THE AUTO GLIDE'S **HOME PITCH DEFAULT POSITION.**



**EXAMPLE 2B: CORRECTING FOR A BOAT THAT IS ROLLED TO PORT, BUT CURRENT PITCH MATCHES THE AUTO GLIDE'S HOME PITCH.**

The Auto Glide always corrects for ROLL CHANGES first and then corrects for PITCH CHANGES. Example 2A shows that the boat is rolled to port, but the **CURRENT PITCH POSITION** matches the **HOME PITCH DEFAULT POSITION**. In this case, the Auto Glide only needs to correct for ROLL ANGLE CHANGE.



TO MAKE A ROLL CORRECTION, THE AUTO GLIDE MOVES BOTH THE PORT AND STARBOARD TRIM TABS AT THE SAME AMOUNT, BUT IN THE OPPOSITE DIRECTION.

MOVING BOTH TRIM TABS THIS WAY, CHANGES THE ROLL ANGLE OF THE BOAT WITHOUT NEGATIVELY AFFECTING **CURRENT PITCH POSITION** OF THE BOAT.

THE TRIM TABS ARE MOVED IN SHORT BURSTS. THE AUTO GLIDE ALSO WAITS BETWEEN EACH MOVEMENT OF THE TRIM TABS SO IT CAN CALCULATE THE RESULTING ROLL ANGLE CHANGE.

AFTER EACH MOVEMENT OF THE TRIM TABS, THE AUTO GLIDE DISPLAYS THE CHANGES TO THE **CURRENT ROLL POSITION** OF BOAT COMPARED TO THE AUTO GLIDE'S **HOME ROLL DEFAULT POSITION**.



THE BURSTS TO THE TRIM TABS BECOME SHORTER AND SHORTER THE CLOSER THE BOAT'S **CURRENT ROLL POSITION** GETS TO THE AUTO GLIDE'S **HOME ROLL DEFAULT POSITION**.

ONCE THE BOAT'S **CURRENT ROLL POSITION** MATCHES THE AUTO GLIDE'S **HOME ROLL DEFAULT POSITION**, THE GREEN CENTER CROSSHAIR LED INDICATOR WILL BE THE ONLY LED ILLUMINATED ON THE CROSS HAIR.

AT THAT POINT, BOTH THE **CURRENT ROLL AND PITCH POSITIONS** WILL MATCH THE AUTO GLIDE'S **HOME ROLL AND PITCH DEFAULT POSITIONS**.



THE AUTO GLIDE CONTINUES TO MOVE THE TRIM TABS IN SHORT BURSTS UNTIL THE **CURRENT ROLL POSITION** MATCHES THE AUTO GLIDE'S **HOME ROLL DEFAULT POSITION**.

THE AUTO GLIDE STOPS MOVING THE TRIM TABS ONCE THE **CURRENT ROLL POSITION** MATCHES THE AUTO GLIDE'S **HOME ROLL DEFAULT POSITION**.



SINCE THE **CURRENT PITCH POSITION** MATCHES THE AUTO GLIDE'S **HOME DEFAULT PITCH POSITION**, NO PITCH CORRECTIONS ARE REQUIRED.

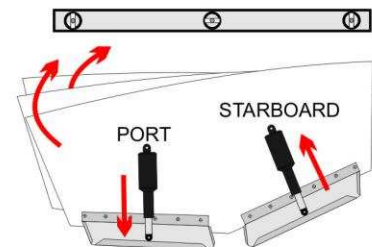

THE STARBOARD TRIM TAB IS MOVED UP AND THE PORT TRIM TAB IS MOVED DOWN IN SHORT, EQUAL BURSTS UNTIL THE BOAT'S **CURRENT ROLL POSITION** MATCHES THE AUTO GLIDE'S **HOME ROLL DEFAULT POSITION**

## 2. PITCH CORRECTION:

The following two examples will explain how the Auto Glide makes Pitch Angle corrections while in PLANING MODE.

### NOTE:

ENGINE TRIM CAN SIGNIFICANTLY AFFECT THE BOAT'S CURRENT PITCH POSITION COMPARED TO THE AUTO GLIDE'S HOME PITCH DEFAULT POSITION. WHILE ON PLANE, MAKE SURE YOUR ENGINE IS TRIMMED TO MATCH THE RUNNING SURFACE OF THE BOAT.

EXAMPLE 3A: BOAT'S CURRENT ROLL POSITION MATCHES THE AUTO GLIDE'S HOME ROLL POSITION, BUT THE CURRENT PITCH POSITION IS ABOVE THE HOME PITCH DEFAULT POSITION.

This example is the exact opposite scenario as EXAMPLE 2A/B: When the boat's CURRENT ROLL POSITION matches the HOME ROLL DEFAULT POSITION, but your CURRENT PITCH POSITION is above the Auto Glide's HOME PITCH DEFAULT POSITION, the Vertical Crosshair LED Indicator will display how far the boat's bow is above the HOME PITCH DEFAULT POSITION.

However, the green center LED will remain illuminated to indicate that the CURRENT HOME ROLL POSITION still matches Auto Glide's HOME ROLL DEFAULT POSITION.

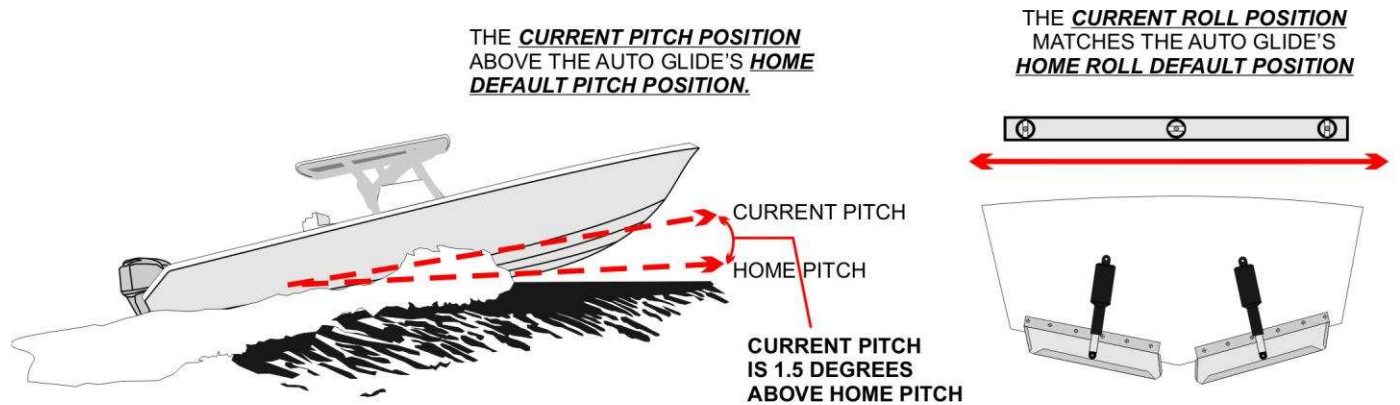

THE 3RD LED ON THE BOTTOM HALF OF THE VERTICAL CROSSHAIR LED INDICATOR IS ILLUMINATED TO INDICATE THAT THE BOAT'S CURRENT PITCH POSITION IS ABOVE THE AUTO GLIDE'S HOME PITCH DEFAULT POSITION.

NOTE: EACH LED ON THE VERTICAL CROSSHAIR LED INDICATOR INDICATES THE BOAT HAS PITCHED 1/2 DEGREE AWAY FROM THE HOME PITCH DEFAULT POSITION.

IN THIS EXAMPLE, THE BOAT HAS PITCHED 3 LEDS = 1.5 DEGREES ABOVE THE HOME ROLL DEFAULT POSITION.



THE GREEN CENTER LED REMAINS ILLUMINATE TO INDICATE THAT THE BOAT'S CURRENT ROLL POSITION STILL MATCHES THE AUTO GLIDE'S HOME ROLL DEFAULT POSITION.

**EXAMPLE 3B: CORRECTING FOR A BOAT THAT IS PITCHED ABOVE THE HOME PITCH DEFAULT POSITION, BUT THE CURRENT ROLL POSITION MATCHES THE AUTO GLIDE'S HOME ROLL POSITION.**

The Auto Glide always corrects for ROLL CHANGES first and then corrects for PITCH CHANGES. Example 3B shows that the boat is above the **HOME PITCH DEFAULT POSITION**, but the **CURRENT ROLL POSITION** matches the **HOME ROLL DEFAULT POSITION**. In this case the Auto Glide only needs to correct for PITCH ANGLE CHANGE.



TO MAKE A PITCH CORRECTION, THE AUTO GLIDE MOVES BOTH TABS UP OR DOWN AT THE SAME TIME.

MOVING BOTH TRIM TABS THIS WAY, CHANGES THE PITCH ANGLE OF THE BOAT WITHOUT NEGATIVELY AFFECTING **CURRENT ROLL POSITION** OF THE BOAT.

THE TRIM TABS ARE MOVED IN SHORT BURSTS. THE AUTO GLIDE ALSO WAITS BETWEEN EACH MOVEMENT OF THE TRIM TABS SO IT CAN CALCULATE THE RESULTING PITCH ANGLE CHANGE.

AFTER EACH MOVEMENT OF THE TRIM TABS, THE AUTO GLIDE DISPLAYS THE CHANGES TO THE **CURRENT PITCH POSITION** OF BOAT COMPARED TO THE AUTO GLIDE'S **HOME PITCH DEFAULT POSITION**.



THE BURSTS TO THE TRIM TABS BECOME SHORTER AND SHORTER THE CLOSER THE BOAT'S **CURRENT PITCH POSITION** GETS TO THE AUTO GLIDE'S **HOME PITCH DEFAULT POSITION**.

ONCE THE BOAT'S **CURRENT PITCH POSITION** MATCHES THE AUTO GLIDE'S **HOME PITCH DEFAULT POSITION**, THE GREEN CENTER CROSSHAIR LED INDICATOR WILL BE THE ONLY LED ILLUMINATED ON THE CROSS HAIR.



THE AUTO GLIDE CONTINUES TO MOVE THE TRIM TABS IN SHORT BURSTS UNTIL THE **CURRENT PITCH POSITION** MATCHES THE AUTO GLIDE'S **HOME PITCH DEFAULT POSITION**.

AT THAT POINT, BOTH THE **CURRENT ROLL AND PITCH POSITIONS** WILL MATCH THE AUTO GLIDE'S **HOME ROLL AND PITCH DEFAULT POSITIONS**.

THE AUTO GLIDE STOPS MOVING THE TRIM TABS ONCE THE **CURRENT PITCH POSITION** MATCHES THE AUTO GLIDE'S **HOME PITCH DEFAULT POSITION**.



BOTH PORT AND STARBOARD TABS ARE MOVED DOWN AT THE SAME TIME, IN SHORT EQUAL BURSTS UNTIL THE BOAT'S **CURRENT PITCH POSITION** MATCHES THE AUTO GLIDE'S **HOME DEFAULT PITCH POSITION**.

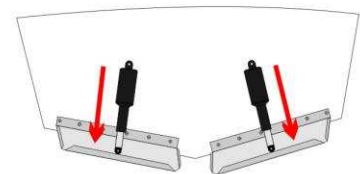

SINCE THE BOAT'S CURRENT ROLL POSITION MATCHES THE AUTO GLIDE'S **HOME ROLL DEFAULT POSITION**, NO ROLL CORRECTIONS ARE REQUIRED.

### 3. YAW LOCKOUT:

The Auto Glide is constantly monitoring the boat's Rate of Turn (YAW), but while in **PLANING MODE** the Auto Glide locks out Roll Corrections in shallow turns and locks out **both** Roll and Pitch Corrections in sharp turns.

Since almost all boats roll into a turn, the Auto Glide locks out roll correction in all turns greater than 1.25 degrees per second. This keeps the Auto Glide from making any unnecessary Roll Correction for temporary roll angle changes that are caused by a boat turning and not by an actual change in a boat's CURRENT ROLL POSITION.

The Auto Glide will continue to make Pitch Corrections in shallow turns, but lock out both Roll and Pitch Corrections in sharp turns.

The following illustrations outline YAW LOCKOUT in detail:

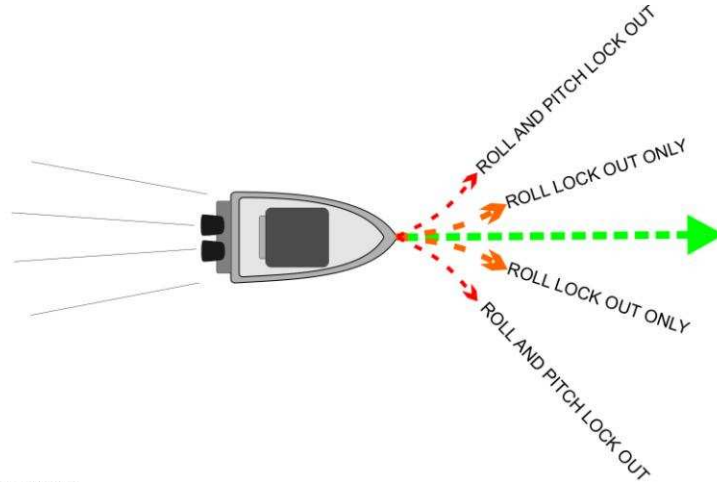

SHALLOW TURN = SLOW BLINK

#### YAW LOCKOUT - SHALLOW TURNS



THE AUTO GLIDE LOCKS OUT ROLL CORRECTIONS IN SHALLOW TURNS.

THE BOAT MUST BE GOING STRAIGHT FOR 2 SECONDS TO ACTIVATE ROLL CORRECTION AFTER IT HAS BEEN LOCKED OUT IN A SHALLOW TURN.

THE AUTO FUNCTION LIGHT WILL BLINK SLOWLY WHEN THE AUTO GLIDE IS IN YAW RATE LOCKOUT.

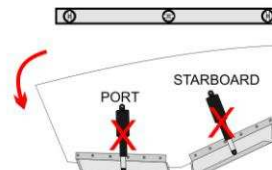

THE AUTO GLIDE WILL NOT CORRECT FOR CHANGES IN ROLL ANGLE DURING A SHALLOW TURN.

#### YAW LOCKOUT - SHARP TURNS

SHARP TURN = FAST BLINK



THE AUTO GLIDE LOCKS OUT BOTH ROLL AND PITCH CORRECTIONS IN SHARP TURNS.

THE BOAT MUST BE GOING STRAIGHT FOR 7 SECONDS TO ACTIVATE ROLL AND PITCH CORRECTIONS AFTER IT HAS BEEN LOCKED OUT IN A SHARP TURNS.

THE AUTO FUNCTION LIGHT WILL BLINK FASTER WHEN THE AUTO GLIDE IS IN YAW RATE LOCK-OUT FOR SHARP TURNS.

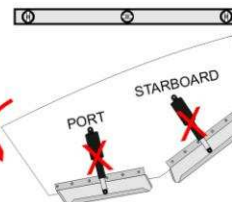

THE AUTO GLIDE WILL NOT CORRECT FOR CHANGES IN ROLL OR PITCH ANGLE DURING A SHARP TURN.



#### 4. **RAPID DECELERATION:**

While the Auto Glide is in PLANING MODE, it is constantly monitoring engine speed (RPM) via the engine's CANBUS. In the event you need to slow the boat down very quickly, the Auto Glide defaults to RAPID DECELERATION MODE that enables you to maintain good visibility throughout the deceleration process as well as helps to slow the boat down more quickly.

Anytime your motor(s) is above 3000 RPMs and you rapidly pull back on the throttle, the Auto Glide will fully deploy the trim tabs if the engine speed drops below 1500 RPMs in less than 2 seconds. The Auto Glide interprets this rapid drop in engine speed as a trigger to immediately deploy the trim tabs.

### **RAPID DECELERATION - TRIM TABS ARE FULLY DEPLOYED**

**RAPID DECELERATION** IS TRIGGERED WHEN ENGINE SPEED (RPM) DROPS FROM ABOVE 3000 RPM TO BELOW 1500 RPM IN LESS THAN 2 SECONDS.

THE AUTO GLIDE **FULLY DEPLOYS THE TRIM TABS** IF THE ENGINE SPEED (RPM) DROPS FROM ABOVE 3000 RPM TO BELOW 1500 RPM IN LESS THAN 2 SECONDS.

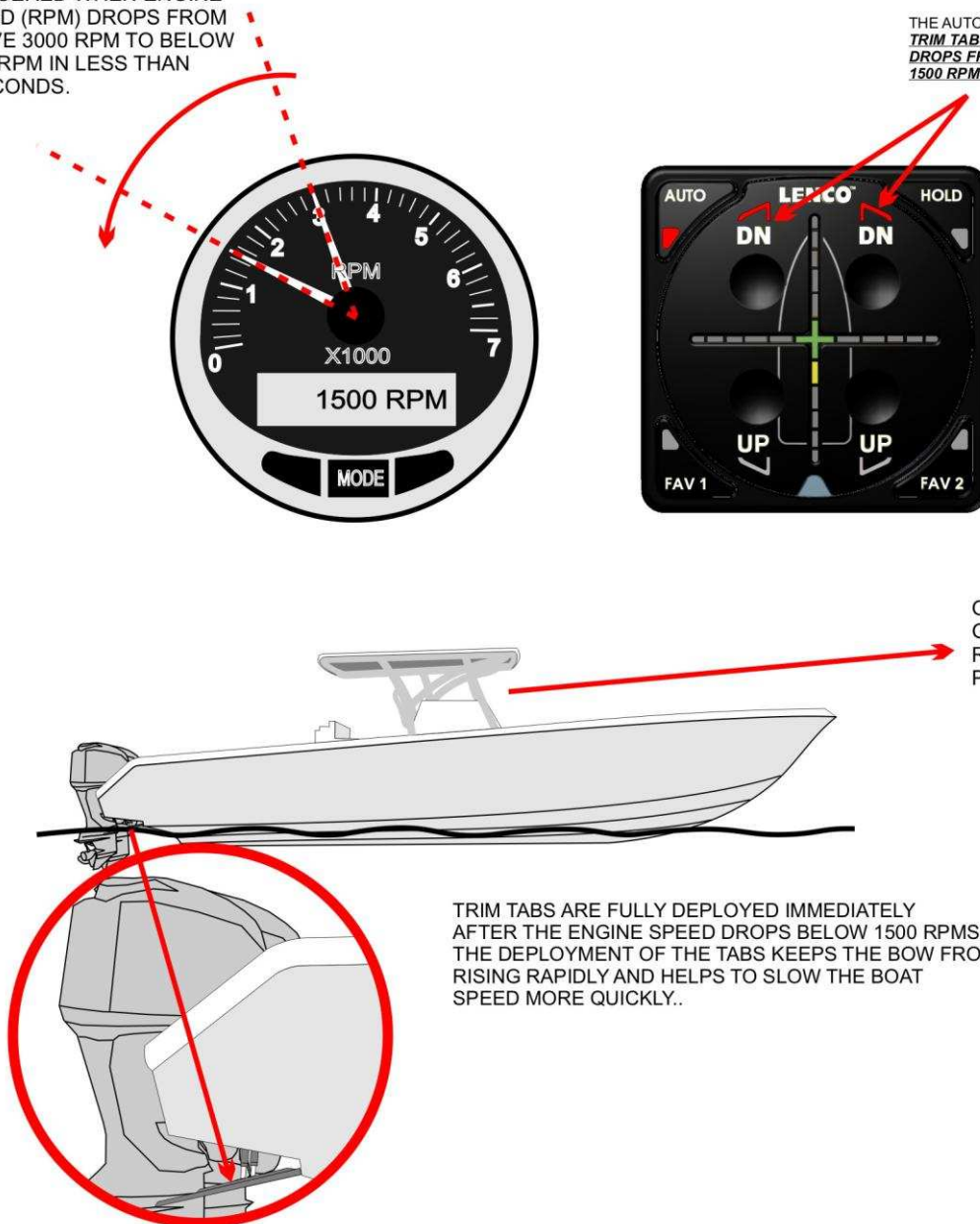

OPERATOR MAINTAINS GOOD VISIBILITY THROUGHOUT RAPID DECELERATION PROCESS

TRIM TABS ARE FULLY DEPLOYED IMMEDIATELY AFTER THE ENGINE SPEED DROPS BELOW 1500 RPMs. THE DEPLOYMENT OF THE TABS KEEPS THE BOW FROM RISING RAPIDLY AND HELPS TO SLOW THE BOAT SPEED MORE QUICKLY..

## 5. **EXITING PLANING MODE:**

As you slow the boat's speed down, the Auto Glide will slowly extend the trim tabs as the boat's **CURRENT PITCH POSITION** rises due to the reduction in speed. If the boat's speed continues to drop and it passes below 7 MPH, the AUTO GLIDE will fully deploy the trim tabs and reverts back to HOLE SHOT MODE.

### **EXIT PLANING MODE - REVERT BACK INTO HOLE SHOT MODE**

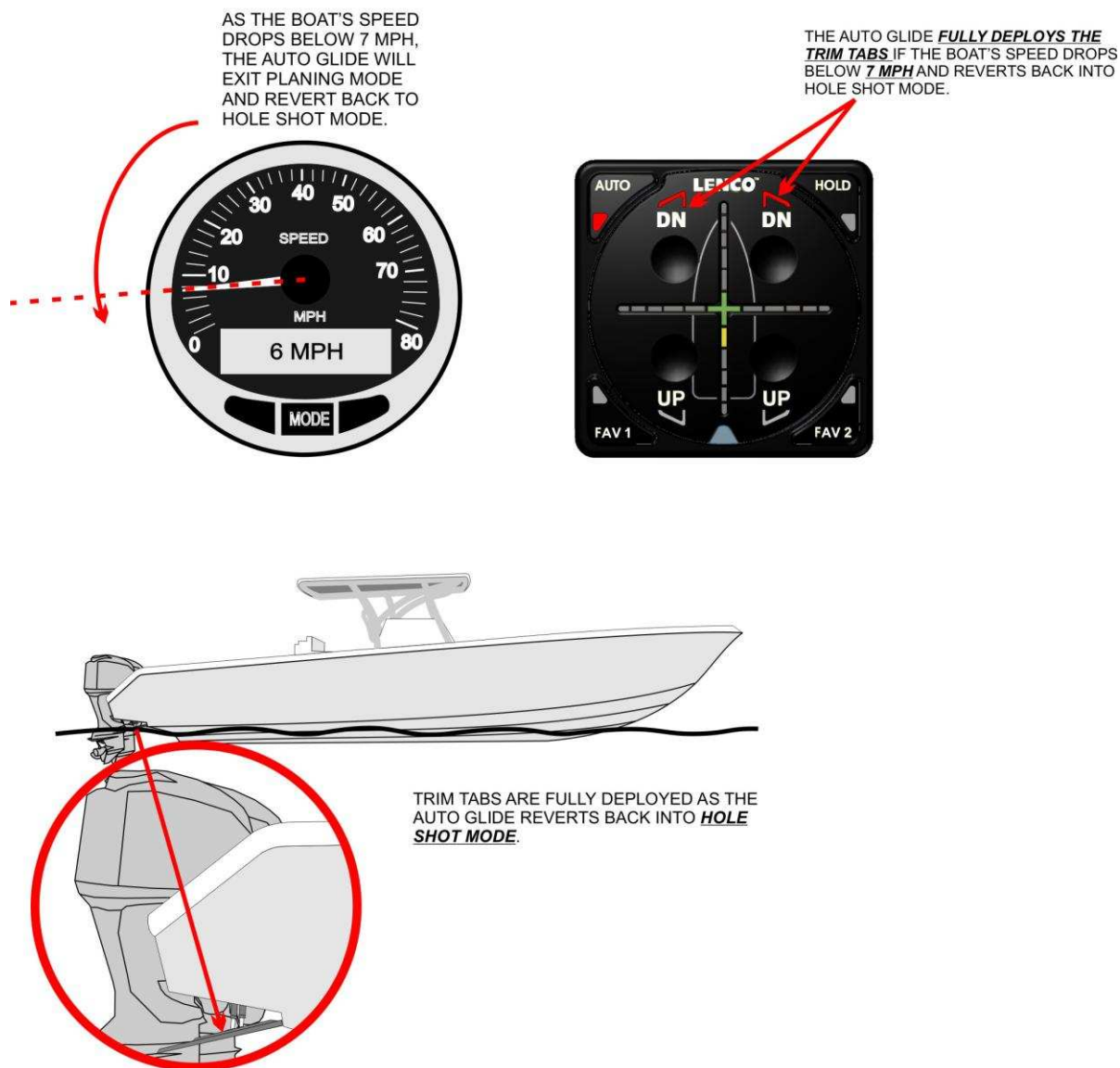

#### **NOTE:**

IF YOUR BOAT'S TRAILER BUNKS EXTEND UNDER THE BOAT'S TRIM TABS, Lenco RECOMMENDS YOU **MANUALLY RETRACT YOUR TRIM TABS BEFORE DRIVING THE BOAT ONTO YOUR TRAILER**. SINCE THE AUTO GLIDE DEPLOYS THE TRIM TABS WHEN IT TRANSITIONS BACK INTO HOLE SHOT MODE FROM PLANING MODE, MANUALLY RETRACTING THE TRIM TABS WILL ENSURE THEY DO NOT MAKE CONTACT WITH YOUR TRAILER BUNKS.

#### **NOTE:**

WHEN DOCKING YOUR BOAT AT DAY'S END (FOR TRAILERING OR DRY STORAGE), REMEMBER TO RETRACT YOUR TABS TO THE UP POSITION IF YOU ARE IN MANUAL MODE.

### III. AUTOMATIC SETTINGS

The Auto Glide has four (4) AUTOMATIC SETTINGS (AUTO, FAV 1, FAV 2 AND HOLD) that enable you to select up to four (4) different HOME ROLL AND PITCH POSITIONS. This section of the operations manual explains why you might want to store different HOME ROLL AND PITCH POSITIONS and how to save these alternative home positions using the Key Pad.

As you know from the previous section, the Auto Glide moves the trim tabs until the boat's CURRENT ROLL AND PITCH POSITIONS match the HOME ROLL AND PITCH POSITIONS. When you first start your motor(s), the Auto Glide defaults to the "AUTO" AUTOMATIC SETTING and levels the boat around the HOME ROLL AND PITCH DEFAULT POSITIONS that were saved during the initial Auto Glide Setup that was described in the Auto Glide Owner's Manual A. However, there will be times when you will want level the boat around a different HOME ROLL AND PITCH POSITION that might not be level from side to side or might not be the most efficient running angle.

#### A. "AUTO" SETTING:

When you set the HOME ROLL AND PITCH DEFAULT POSITIONS during the SETUP PROCESS described in the Auto Glide Owner's Manual A, the Auto Glide saved those positions as the HOME ROLL AND PITCH POSITIONS for the "AUTO" AUTOMATIC SETTING.

#### HOME ROLL AND PITCH POSITIONS FOR "AUTO" AUTOMATIC SETTING



WHEN THE "AUTO" LED INDICATOR IS ILLUMINATED, THE AUTO GLIDE USES THE HOME ROLL AND PITCH DEFAULT POSITIONS THAT WERE SAVED DURING THE AUTO GLIDE SETUP PROCESS DESCRIBED IN OWNER'S MANUAL A.

THE AUTO GLIDE WILL MOVE THE TRIM TABS UNTIL THE CURRENT ROLL AND PITCH POSITIONS MATCH THE SAVED HOME ROLL AND PITCH DEFAULT POSITIONS.

THE "AUTO" HOME PITCH DEFAULT POSITION IS SET DURING THE AUTO GLIDE'S SETUP PROCESS AND IS CALCULATED AS THE BOAT'S MOST EFFICIENT RUNNING ANGLE.

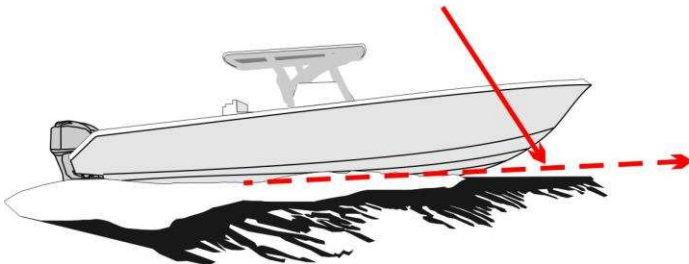

THE "AUTO" HOME ROLL DEFAULT POSITION IS SET DURING THE AUTO GLIDE'S SETUP PROCESS AND IS SET WHEN THE BOAT IS LEVEL FROM SIDE TO SIDE.

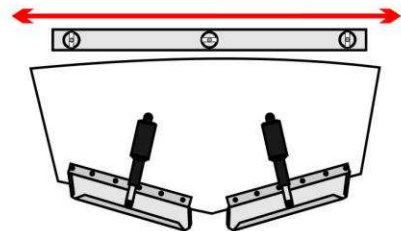

Even though the **“AUTO” SETTING’S HOME ROLL AND PITCH POSITIONS** will keep the boat level side to side and running at its most efficient pitch angle, there will be times that the water conditions may be choppy or coming at the boat at an angle and the boat will run more comfortably if it wasn’t level or running at its most efficient running angle. During these adverse water conditions, the Auto Glide provides you with the option of storing three additional automatic **HOME ROLL AND PITCH POSITIONS** that might make the boat run more comfortably.

**B. “FAV 1”, “FAV 2” and “HOLD” AUTOMATIC SETTINGS:**

The Auto Glide has three additional **AUTOMATIC SETTINGS; FAV 1, FAV 2 and HOLD.** Each of these settings can save **HOME ROLL AND PITCH POSITIONS** that are different from the “AUTO” SETTING’S HOME ROLL AND PITCH POSITIONS. The “FAV 1” and “FAV 2” alternative HOME ROLL AND PITCH POSITIONS are permanently saved in the Auto Glide and are available to you anytime you press the “FAV 1” or “FAV 2” BUTTONS on the Key Pad. The “HOLD” alternative HOME ROLL AND PITCH POSITION is only temporarily saved in the Auto Glide and will be erased whenever you press any other button on the Key Pad or turn “OFF” your motor(s).

**1. SAVING “FAV 1” and “FAV 2” HOME ROLL AND PITCH POSITIONS:**

Before you can save an alternative **HOME ROLL AND PITCH SETTINGS for “FAV 1” and “FAV 2”**, you must first place the Auto Glide in **MANUAL MODE**, by pressing any of the four UP/DN buttons on the Key Pad. This puts the Auto Glide in **MANUAL MODE** and you are now in control of the trim tabs.

**CHANGE HOME ROLL AND PITCH POSITIONS**

ONCE AN UP OR DN BUTTON IS PRESSED, THE **“AUTO” LED INDICATOR** WILL NO LONGER BE ILLUMINATED AND THE AUTO GLIDE WILL BE IN MANUAL MODE.



PRESS THE UP OR DN BUTTON ON THE KEY PAD TO CHANGE THE ROLL AND PITCH ANGLE OF THE BOAT.

THE CROSSHAIR LED INDICATORS ON THE KEY PAD WILL CONTINUE TO DISPLAY THE CURRENT POSITION OF THE BOAT AS THE ROLL AND PITCH ANGLES CHANGE.

THE **CURRENT PITCH POSITION** WILL GO BELOW **HOME PITCH POSITION** WHEN THE STARBOARD DN BUTTON ON THE KEY PAD IS PRESSED.

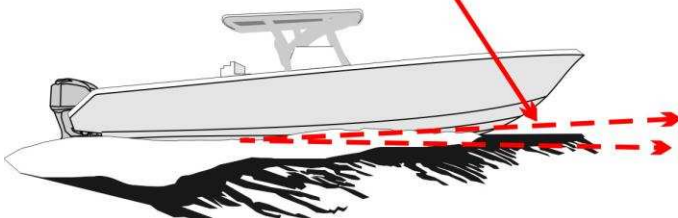

THE **CURRENT ROLL POSITION** WILL ALSO ROLL TO THE STARBOARD OF THE **HOME ROLL POSITION** WHEN THE STARBOARD DN BUTTON ON THE KEY PAD IS PRESSED.

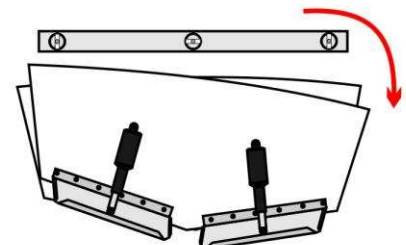



You must find your desired roll and pitch position by manually operating the trim tabs. Once the boat reaches the desired roll and pitch angles, press and hold the **“FAV 1” or “FAV 2” BUTTON** until the corresponding **“FAV 1” or “FAV 2” LED INDICATOR** flashes five (5) times. Once the **“FAV 1” or “FAV 2” LED INDICATOR** stops flashing, the Auto Glide saves the alternative **HOME ROLL AND PITCH POSITION** and the boat will begin leveling around that roll and pitch angle.

**SAVE “FAV 1” OR “FAV 2” HOME ROLL AND PITCH POSITIONS**



ONCE YOU HAVE FOUND THE DESIRED PITCH AND ROLL ANGLE, **PRESS AND HOLD** EITHER THE **“FAV 1”** OR THE **“FAV 2”** **BUTTONS**.



ONCE THE AUTO GLIDE HAS SAVED THE ALTERNATIVE **HOME ROLL AND PITCH POSITIONS** FOR **“FAV 1”** OR **“FAV 2”**, THE CORRESPONDING LED INDICATOR WILL FLASH FIVE (5) TIMES.

THE CENTER GREEN LED INDICATOR ON THE CROSSHAIR WILL ALSO ILLUMINATE INDICATING THE AUTO GLIDE IS LEVELING AROUND THE SAVED **“FAV 1”** OR **“FAV 2”** **HOME ROLL AND PITCH POSITION**.

**NOTE:** IF YOU RELEASE THE **“FAV 1”** OR **“FAV 2”** **BUTTON** BEFORE THE CORRESPONDING LED INDICATOR FLASHES FIVE (5) TIMES, THE ALTERNATIVE **HOME ROLL AND PITCH POSITION** WILL NOT BE SAVED.

THE LOWER PITCH ANGLE WILL BECOME THE ALTERNATIVE **HOME PITCH POSITION** FOR THE **“FAV 1”** OR **“FAV 2”** **AUTOMATIC SETTING**.

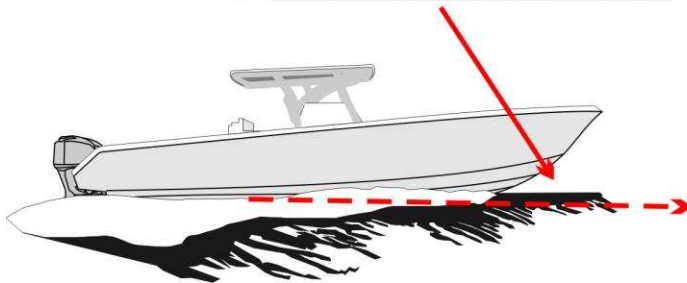

THE STARBOARD ROLL ANGLE WILL ALSO BECOME THE **HOME ROLL POSITION** FOR THE **“FAV 1”** OR **“FAV 2”** **AUTOMATIC SETTING**.

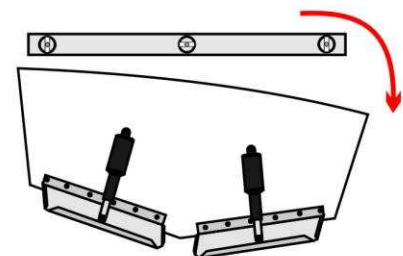

**2. RESETTING “FAV 1” AND “FAV 2” HOME ROLL AND PITCH POSITIONS:**

Once a **HOME ROLL AND PITCH POSITION** has been saved for **“FAV 1”** and/or **“FAV 2”**, the positions are permanently stored in the Auto Glide. You can turn your motor(s) and battery switch(s) off and these alternative HOME ROLL AND PITCH POSITIONS will continue to be saved in the Auto Glide. However, if you ever want to change the HOME AND PITCH POSITIONS for either of the **“FAV 1”** or **“FAV 2”** **AUTOMATIC SETTINGS**, you simply have to go into **MANUAL MODE**, manually change the roll and pitch positions of the boat as described earlier in this section, and then press and hold the corresponding **“FAV 1”** or **“FAV 2”** **BUTTON** until the LED INDICATOR flashes five (5) times.

**3. SAVING “HOLD” HOME ROLL AND PITCH POSITIONS:**

Saving the **“HOLD” HOME ROLL AND PITCH POSITIONS** are very similar to saving the **“FAV 1” or “FAV 2” HOME ROLL AND PITCH POSITIONS**. Once the boat reaches the desired roll and pitch angles, **PRESS** and **RELEASE** the **“HOLD” BUTTON**. Since the **“HOLD” HOME ROLL AND PITCH POSITIONS** is only a temporary position, you do not have to continue to hold the “HOLD” BUTTON for the Auto Glide to save the **CURRENT ROLL AND PITCH POSITION** as the **HOME ROLL AND PITCH POSITION**.

**SAVE “HOLD” HOME ROLL AND PITCH POSITIONS**



ONCE THE BOAT HAS REACHED THE DESIRED PITCH AND ROLL ANGLE, **PRESS AND RELEASE THE “HOLD” BUTTON**.



ONCE THE AUTO GLIDE HAS SAVED THE ALTERNATIVE **HOME ROLL AND PITCH POSITIONS** FOR “HOLD”, THE LED INDICATOR WILL ILLUMINATE.

THE CENTER GREEN LED INDICATOR ON THE CROSSHAIR WILL ALSO ILLUMINATE INDICATING THE AUTO IS LEVELING AROUND THE SAVED **“HOLD” HOME ROLL AND PITCH POSITION**.

**NOTE:** THE **“HOLD” HOME ROLL AND PITCH POSITION** IS ONLY A TEMPORARY SETTING. IT WILL BE ERASED AS SOON AS YOU TOUCH ANY BUTTON ON THE KEY PAD OR TURN OFF YOUR MOTOR(S)

THE LOWER PITCH ANGLE WILL BECOME THE TEMPORARY **HOME PITCH POSITION** FOR THE **“HOLD” AUTOMATIC SETTING**.



THE STARBOARD ROLL ANGLE WILL ALSO BECOME THE TEMPORARY **HOME ROLL POSITION** FOR THE **“HOLD” AUTOMATIC SETTING**.

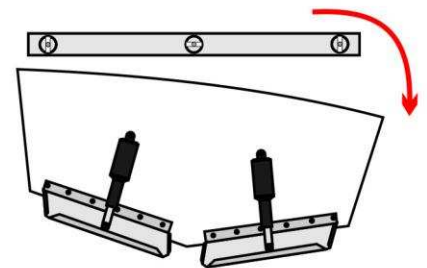

**NOTE:**  
The “HOLD” home roll and pitch position is only a temporary setting. It will be erased as soon as you touch any button on the key pad or turn off your motor(s).

## IV. MANUAL OPERATIONAL MODES

MANUAL OPERATIONAL MODES allow you to manually control the trim tabs and stops **ALL** automatic boat control decisions. There are two types of MANUAL OPERATIONAL MODES:

- A. MANUAL MODE
- B. LIMP HOME MODE

**NOTE:**

Although the AUTO GLIDE defaults to **"AUTO"** mode when you first start your motor(s), it is important that you understand the two **MANUAL OPERATIONAL MODES** so you can take manual control of your trim tabs at any time.

### A. **MANUAL MODE:**

**ACTIVATE MANUAL MODE:** Manual Mode is activated by pressing any of the UP/DN Buttons while the Auto Glide is in any of the four (4) **AUTOMATIC SETTINGS (AUTO, FAV 1, FAV 2 or HOLD)**. As soon as you touch any UP or DN button, **all automatic boat control decisions stop** and you assume full manual control of the trim tabs. The four (4) UP/DN buttons control the trim tabs the same as any of the existing Lenco manual trim tab switches.

### **ACTIVATE MANUAL MODE**



PRESS ANY OF THE FOUR (4) UP/DN BUTTONS TO ACTIVATE **MANUAL MODE.**

ENTERING **MANUAL MODE** STOPS ALL AUTOMATIC BOAT CONTROL DECISIONS.

**HOW TO MANUALLY CONTROL TRIM TABS:**

The Manual Operation of all Lenco Trim Tab Switches is based on the position of the **bow**. To lower the starboard bow, press the right (starboard) side of the switch where it reads **DN**. This lowers the port tab. To lower the port bow, press the left (port) side of the switch where it reads **DN**. This lowers the starboard tab.

**MANUAL MODE - BUTTON CONTROL**

PRESS TO LOWER PORT BOW      PRESS TO LOWER STARBOARD BOW



PRESS PORT DN BUTTON TO LOWER STARBOARD BOW

PRESS STARBOARD DN BUTTON TO LOWER STARBOARD BOW

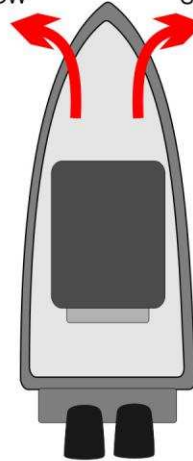

PRESS TO RAISE PORT BOW

PRESS TO RAISE STARBOARD BOW

PRESS PORT UP BUTTON TO RAISE STARBOARD BOW

PRESS STARBOARD DN BUTTON TO RAISE STARBOARD BOW

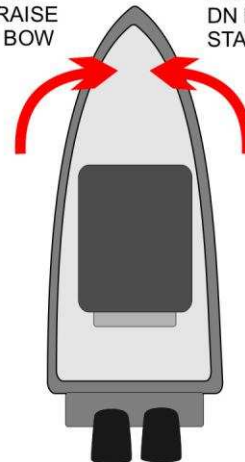

1. **EXIT MANUAL MODE:**

You can exit **MANUAL MODE** by pressing any of the four (4) **AUTOMATIC SETTING BUTTONS**. As soon as you press one of the **AUTOMATIC SETTING BUTTONS**, the Auto Glide will begin automatically controlling the position of the boat based on its **CURRENT ROLL AND PITCH POSITIONS** and the Auto Glide's **HOME ROLL AND PITCH POSITIONS** for that **AUTOMATIC SETTING**.

**EXIT MANUAL MODE**

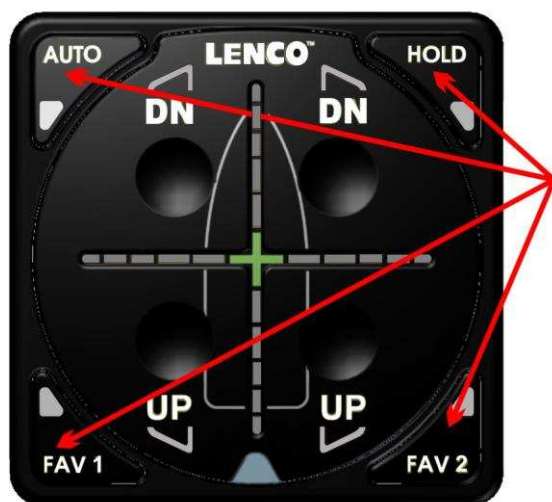

PRESS ANY OF THE FOUR (4) **AUTOMATIC SETTING BUTTONS** ON THE OUTSIDE FOUR (4) CORNERS OF THE KEY PAD TO EXIT **MANUAL MODE**.

**NOTE:**

If you turn off your motor(s) while the Auto Glide is in **MANUAL MODE**, the trim tabs will not automatically retract. However, they will retract the next time you start your motor(s) to ensure the trim tabs are fully retracted.

B. **LIMP HOME MODE:**

**LIMP HOME MODE** is a SAFETY DEFAULT MODE that occurs when the Auto Glide either loses necessary data it needs to perform automatic boat control decisions or there is a product failure. These possible situations are described in section V (page 33) of this manual. The Auto Glide is constantly monitoring DATA and as soon as it senses a problem, the Auto Glide stops all automatic decisions and defaults to **LIMP HOME MODE**.

**NOTE:**

Whenever pertinent information is lost or a trim tab actuator fails, the Auto Glide will flash a sequence of **SYSTEM FAILURE WARNING MESSAGES**. These messages will be described in more detail on pages 33-38.

Although **LIMP HOME MODE** is very similar to **MANUAL MODE** in that it gives the operator manual control of the trim tabs, the only buttons on the key pad that function in **LIMP HOME MODE** are the UP/DN Buttons. You **cannot** exit **LIMP HOME MODE** by pressing an **AUTOMATIC SETTING BUTTON** on the key pad. You can only exit out of **LIMP HOME MODE** if the lost DATA returns or you turn the motor(s) OFF and ON again.

The following illustrations outline the sequence of LED flashes that indicate that the Auto Glide has detected a problem and is defaulting to **LIMP HOME MODE**:

**LIMP HOME MODE - INITIAL LED SEQUENCE**



IMMEDIATELY FOLLOWING THE LOSS OF NECESSARY DATA, THE FOUR (4) **AUTOMATIC SETTING** LED INDICATORS WILL FLASH.

THE CROSSHAIR LED INDICATORS WILL ALSO CONVERGE TO THE CENTER .

As soon as the initial LED flash sequence is over, the Key Pad will begin to flash a **SYSTEM FAILURE WARNING MESSAGE** and begin to automatically retract the trim tabs in short bursts until they are fully retracted.

**LIMP HOME MODE - SYSTEM FAILURE WARNING MESSAGE AND AUTO RETRACTION**



DEPENDING ON THE TYPE OF DATA LOSS, THE AUTO GLIDE WILL FLASH A SEQUENCE OF **SYSTEM FAILURE WARNING MESSAGES** .

THE **SYSTEM FAILURE WARNING MESSAGES** CAN BE FOUND ON PAGES 33 THRU 39.

IN ALL DATA LOSS SITUATIONS, THE KEY PAD WILL CONTINUE TO FLASH THE **SYSTEM FAILURE WARNING MESSAGE** AND SLOWLY RETRACT THE TRIM TABS.

Anytime the Auto Glide is flashing a **SYSTEM FAILURE WARNING MESSAGE** and is retracting the trim tabs, you can override the retraction and default immediately to **LIMP HOME MODE** by pressing any of the four (4) UP/DN Buttons. If you do not override the retraction process during a **SYSTEM FAILURE WARNING MESSAGE**, the Auto Glide will continue to automatically retract the trim tabs until they are fully retracted. Once the tabs are fully retracted, the Auto Glide will default to **LIMP HOME MODE**.

### **LIMP HOME MODE - OVERRIDE AUTO RETRACTION**



PRESS ANY OF THE FOUR (4) UP/DN BUTTONS TO OVERRIDE THE **AUTO RETRACTION PROCESS** AND MANUALLY DEFAULT TO **LIMP HOME MODE**.

NOTE: IF YOU DO NOT OVERRIDE THE **AUTO RETRACTION PROCESS**, THE AUTO GLIDE WILL DEFAULT TO **LIMP HOME MODE** WHEN THE TRIM TABS ARE FULLY RETRACTED.

As soon as the Auto Glide has defaulted to **LIMP HOME MODE**, the red outside tips and the green center of the **CROSSHAIR LED INDICATORS** will flash every four (4) seconds. The LED Indicators will continue to flash until all of the required DATA is reacquired or the motor(s) is turned "OFF".

### **LIMP HOME MODE - LED INDICATORS**



THE OUTSIDE RED TIPS AND THE GREEN CENTER OF CROSSHAIR LED INDICATORS WILL FLASH EVERY FOUR (4) SECONDS TO INDICATE THE AUTO GLIDE IS IN **LIMP HOME MODE**.

THE LEDS WILL CONTINUE TO FLASH UNTIL THE DATA IS REACQUIRED OR THE MOTOR(S) ARE TURNED OFF.

**NOTE:**  
While in **LIMP HOME MODE**, you can press all four (4) of the UP/DN Buttons on the Key Pad and the Auto Glide will display the **SYSTEM FAILURE WARNING MESSAGE** on the Crosshair LED Indicators.

If the lost Data is reacquired while the Auto Glide is in **LIMP HOME MODE**, the Key Pad will flash a **REACQUIRED DATA MESSAGE** that indicates the Auto Glide has regained all the information it needs to make automatic boat control decisions. However, the Auto Glide will default back to **MANUAL MODE** so that you have to make a conscious decision to go back into an **AUTOMATIC SETTING**.

**LIMP HOME MODE - REACQUIRED DATA MESSAGE INDICATING FULL DATA RECEPTION**



IF ENGINE AND GPS DATA IS REACQUIRED, THE KEY PAD WILL FLASH A **REACQUIRED DATA MESSAGE** INDICATING ALL OF THE REQUIRED INFORMATION IS BEING RECEIVED.

THE **SYSTEM FAILURE WARNING MESSAGES** CAN BE FOUND ON PAGES 33 THRU 38.

The **REACQUIRED DATA MESSAGE** will flash five times to inform you that the Auto Glide has all of the required Data needed to perform automatic boat control decisions. However, the Auto Glide defaults back to **MANUAL MODE** after flashing the **REACQUIRED DATA MESSAGE**.

Once the Auto Glide has transitioned back into **MANUAL MODE**, you can either continue to control the boat's trim tabs manually or you can press any of the four (4) **AUTOMATIC SETTING BUTTONS** so the Auto Glide can return to controlling the boat's **ROLL AND PITCH POSITIONS** automatically.

**DEFAULT BACK TO MANUAL MODE OPERATION**



ONCE THE AUTO GLIDE DEFAULTS BACK INTO **MANUAL MODE**, YOU CAN CONTINUE TO OPERATE THE TRIM TABS MANUALLY OR YOU CAN SELECT ANY OF THE FOUR (4) **AUTOMATIC SETTING BUTTONS** AND THE AUTO GLIDE WILL AUTOMATICALLY CONTROL YOUR BOAT'S **ROLL AND PITCH POSITIONS**.



## V. SYSTEM FAILURE WARNING MESSAGES

There are six (6) **SYSTEM FAILURE WARNING MESSAGES** that flash on the key pad whenever the Auto Glide loses any of the required engine or GPS data, loses communication with the Key Pad, if the Auto Glide Control Box becomes loose from its mounting location or if one of the trim tab actuators draws too much current.

**NOTE:**

While in LIMP HOME MODE, you can press all four (4) of the UP/DN Buttons on the Key Pad and the Auto Glide will display the **SYSTEM FAILURE WARNING MESSAGE** on the Crosshair LED Indicators.

### A. **DATA LOSS FAILURE:**

There are three types of data loss scenarios that could cause the Auto Glide to flash a **SYSTEM FAILURE WARNING MESSAGE: GPS DATA LOSS, ENGINE DATA LOSS, OR KEY PAD COMMUNICATION LOSS.**

The following illustrations outline the sequence of flashes that occur on the Key Pad when the Auto Glide loses either GPS or Engine CANBUS data.

#### **DATA LOSS - SYSTEM WARNING MESSAGE - INITIAL LED SEQUENCE**



IMMEDIATELY FOLLOWING THE LOSS OF ENGINE OR GPS DATA, THE FOUR (4) **AUTOMATIC SETTING** LED INDICATORS WILL FLASH.

THE CROSSHAIR LED INDICATORS WILL ALSO CONVERGE TO THE CENTER .

Once the Auto Glide completes the initial LED sequence of flashes, it will display the corresponding **SYSTEM FAILURE WARNING MESSAGE.**

### B. **GPS DATA LOSS:**

#### **SYSTEM FAILURE MESSAGE - GPS DATA LOSS**

**NOTE:** IF THE BOAT HAS A **DIGITAL SHIFT SYSTEM**, THE KEY PAD WILL ALSO SCROLL FROM THE **CENTER TO THE NINE O'CLOCK** POSITION.



WHEN GPS DATA LOSS OCCURS, THE AUTO GLIDE WILL FLASH THE OUTSIDE FOUR (4) **AUTOMATIC SETTING LED INDICATORS** AND THE CROSSHAIR LED INDICATORS WILL SCROLL FROM THE **CENTER TO THE SIX O'CLOCK** POSITION.

**NOTE:** IN ALL DATA LOSS SITUATIONS, THE AUTO GLIDE RETRACTS THE TRIM TABS WITH SLOW BURSTS UNTIL THEY ARE FULLY RETRACTED OR YOU OVERRIDE THE RETRACTION BY PRESSING ANY OF THE UP/DN BUTTONS ON THE KEY PAD.

C. ENGINE DATA LOSS:

SYSTEM FAILURE MESSAGE - ENGINE DATA LOSS



WHEN ENGINE DATA LOSS OCCURS, THE AUTO GLIDE WILL FLASH THE OUTSIDE FOUR (4) **AUTOMATIC SETTING LED INDICATORS** AND THE CROSSHAIR LED INDICATORS WILL SCROLL FROM THE **CENTER TO THE TWELVE O'CLOCK POSITION** AND FROM THE **CENTER TO THE THREE O'CLOCK POSITION**.

**NOTE:** IN ALL DATA LOSS SITUATIONS, THE AUTO GLIDE RETRACTS THE TRIM TABS WITH SLOW BURSTS UNTIL THEY ARE FULLY RETRACTED OR YOU OVERRIDE THE RETRACTION BY PRESSING ANY OF THE UP/DN BUTTONS ON THE KEY PAD.

Once the trim tabs have fully retracted or you have pressed an UP/DN Button to override the **GPS OR ENGINE DATA LOSS - SYSTEM FAILURE WARNING MESSAGE**, the Auto Glide will default to **LIMP HOME MODE**. You can read more about **LIMP HOME MODE** on pages 29 thru 32.

LIMP HOME MODE - LED INDICATORS



THE OUTSIDE RED TIPS AND THE GREEN CENTER OF CROSSHAIR LED INDICATORS WILL FLASH EVERY FOUR (4) SECONDS TO INDICATE THE AUTO GLIDE IS IN **LIMP HOME MODE**.

THE LEDS WILL CONTINUE TO FLASH UNTIL THE CANBUS DATA IS REACQUIRED OR THE MOTOR(S) ARE TURNED OFF.

**D. KEY PAD COMMUNICATION LOSS:**

The Auto Glide Key Pad is a CANBUS based device that communicates with the Auto Glide Control Box via NMEA 2000 protocol. The Key Pad is in constant communication with the Control Box as it sends and receives boat control messages.

If the Key Pad fails to communicate with the Control Box, the Auto Glide will stop all automatic boat control decisions and retract the trim tabs in short bursts. The Key Pad will also go blank and none of the Key Pad buttons will respond.

**SYSTEM FAILURE MESSAGE - KEY PAD COMMUNICATION LOSS**



IF THE KEY PAD LOSES COMMUNICATION WITH THE AUTO GLIDE CONTROL BOX, THE KEY PAD WILL GO BLANK AND NO LED INDICATORS WILL BE ILLUMINATED.

THE KEY PAD WILL REMAIN BLANK UNTIL COMMUNICATION IS RE-ESTABLISHED WITH THE AUTO GLIDE CONTROL BOX.

**NOTE:** IF THE KEY PAD LOSES COMMUNICATION, THE AUTO GLIDE RETRACTS THE TRIM TABS WITH SLOW BURSTS UNTIL THEY ARE FULLY RETRACTED. HOWEVER, SINCE THE KEY PAD CAN NOT COMMUNICATE WITH THE CONTROL BOX IT **CAN NOT DISPLAY** THE RETRACTION ON THE **UP LED INDICATORS**.

**E. REACQUIRED DATA LOSS:**

The Auto Glide will remain in **LIMP HOME MODE** (or blank when the Key Pad loses communication) until either the lost GPS or engine data is reacquired, the Key Pad regains communication with the Control Box or you turn "OFF" your motor(s). Once the Auto Glide reacquires the lost data, it will flash a **REACQUIRED DATA – SYSTEM FAILURE WARNING MESSAGE** and then default to **MANUAL MODE**.

**SYSTEM FAILURE MESSAGE - REACQUIRED DATA**

**NOTE:** IF THE BOAT HAS A **DIGITAL SHIFT SYSTEM**, THE KEY PAD WILL ALSO SCROLL FROM THE **CENTER TO THE NINE O'CLOCK POSITION**.

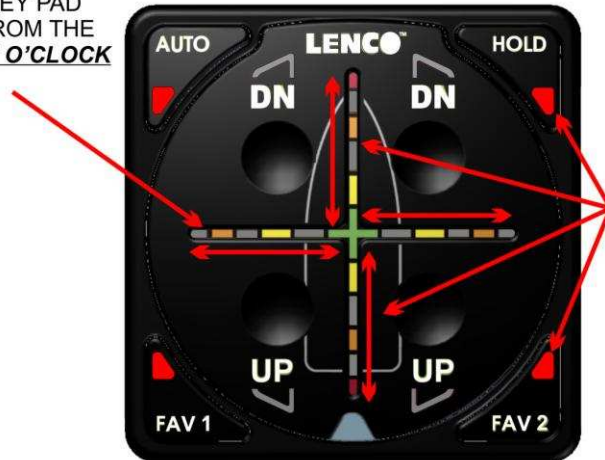

IF THE LOST GPS OR ENGINE DATA IS REACQUIRED BY THE AUTO GLIDE, IT WILL FLASH THE OUTSIDE FOUR (4) **AUTOMATIC SETTING LED INDICATORS** AND ALL FOUR (4) QUADRANTS OF THE CROSSHAIR LED INDICATORS.

THE KEY PAD WILL CONTINUE TO FLASH THIS MESSAGE FOR FIVE (5) SECONDS AND THEN THE AUTO GLIDE WILL DEFAULT TO MANUAL MODE.

Once the Auto Glide defaults back to MANUAL MODE, you can either continue to control the trim tabs manually or you can select any of the four (4) AUTOMATIC SETTING BUTTONS.

**EXIT MANUAL MODE**



PRESS ANY OF THE FOUR (4) **AUTOMATIC SETTING BUTTONS** ON THE OUTSIDE FOUR (4) CORNERS OF THE KEY PAD TO EXIT **MANUAL MODE**.

**F. ACTUATOR OVER-AMPERAGE:**

The Auto Glide constantly monitors the amp draw of each actuator in the trim tab system. In the event that an actuator draws too much current and begins to malfunction, the Auto Glide will flash an ACTUATOR OVER-AMPERAGE WARNING MESSAGE, default to LIMP HOME MODE and lockout the failed actuator in whichever direction it was moving at the time of the failure (extending or retracting).

The ACTUATOR OVER-AMPERAGE message will indicate which actuator has failed and in which direction it failed. Once the Auto Glide defaults to LIMP HOME MODE and locks out the failed actuator, you will not be able to move it in the same direction that it was moving at the time of the failure. However, you will be able to move the failed actuator in the opposite direction.

An example of an ACTUATOR OVER-AMPERAGE failure would be when the Auto Glide is attempting to extend the trim tabs during an automatic boat control decision, but the starboard actuator fails due to high current draw. The Auto Glide will flash an **ACTUATOR OVER-AMPERAGE – SYSTEM FAILURE WARNING MESSAGE**, default to LIMP HOME MODE and lock out the actuator from extending any further. You can manually retract the failed actuator by pressing the corresponding UP BUTTON. The following illustration outlines this example:

**EXAMPLE: ILLUSTRATION OF ACTUATOR OVER-AMPERAGE FAILURE**

**STEP 1 – AUTO GLIDE SENSES OVER-AMPERAGE FAILURE**

**ACTUATOR OVER AMPERAGE - SYSTEM FAILURE WARNING MESSAGE**



DURING AN AUTOMATIC BOAT CONTROL DECISION, THE AUTO GLIDE EXTENDS BOTH ACTUATORS TO CORRECT FOR A PITCH ANGLE THAT IS ABOVE THE HOME PITCH POSITION.

DURING THE EXTENSION OF THE TRIM TABS, THE STARBOARD ACTUATOR EXPERIENCES AN OVER AMPERAGE FAILURE.

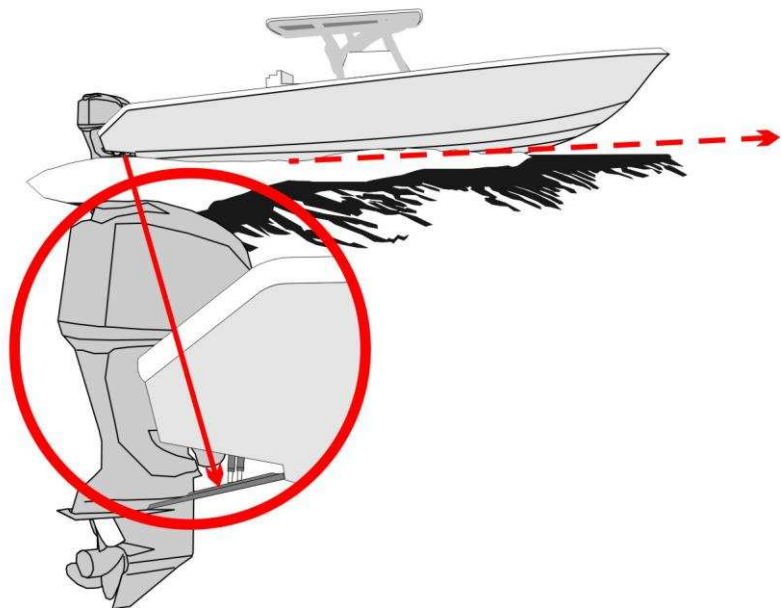
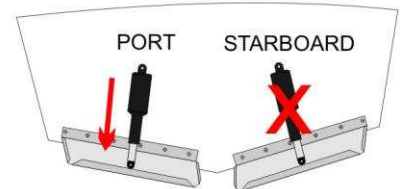

**STEP 2 – AUTO GLIDE DISPLAYS SYSTEM FAILURE MESSAGE AND DEFAULTS TO LIMP HOME**

**NOTE:** IN THIS EXAMPLE, THE STARBOARD ACTUATOR EXPERIENCED AN OVER AMPERAGE FAILURE WHILE EXTENDING SO THE PORT DN LED INDICATOR WILL FLASH AND THEN REMAIN ILLUMINATED.



AS SOON AS THE AUTO GLIDE DETERMINES THERE IS AN **ACTUATOR OVER AMPERAGE FAILURE**, THE AUTOMATIC SETTING LED INDICATORS WILL FLASH RAPIDLY.

THE CORRESPONDING **UP/DN LED INDICATOR** WILL ALSO FLASH AND THEN REMAIN ILLUMINATED.



THE AUTO GLIDE WILL DEFAULT TO **LIMP HOME MODE**. YOU WILL NOT BE ALLOWED TO MANUALLY EXTEND THE STARBOARD ACTUATOR, BUT YOU WILL BE ALLOWED TO RETRACT IT.

THE PORT ACTUATOR WILL MANUALLY EXTEND OR RETRACT.

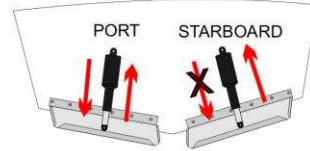

Once the Auto Glide defaults to **LIMP HOME MODE** and displays an **ACTUATOR OVER AMPERAGE FAILURE MESSAGE**, you will have to turn your motor(s) “OFF” and then “ON” again to reset the Auto Glide.

**G. CONTROL BOX OUT OF OPERATIONAL TOLERANCE:**

The Auto Glide Control Box contains sensors that measure roll angles, pitch angles and yaw (rate of turn). When the Auto Glide Control Box is attached to the boat, the sensors measure the boat’s roll angles, pitch angles and yaw. If the Control Box becomes detached from its mounting location, these measurements would become inaccurate.

To protect from these potentially inaccurate pitch and roll readings, the Auto Glide constantly monitors the maximum pitch and roll angle changes the boat makes at any given time. If the changes in roll or pitch angle exceed a predetermined threshold for more than 10 seconds, the Auto Glide will flash a **OUT OF OPERATIONAL TOLERANCE WARNING MESSAGE**, stop all automatic boat control decisions and default to **LIMP HOME MODE**.

**OUT OF OPERATIONAL TOLERANCE - SYSTEM FAILURE WARNING MESSAGE**

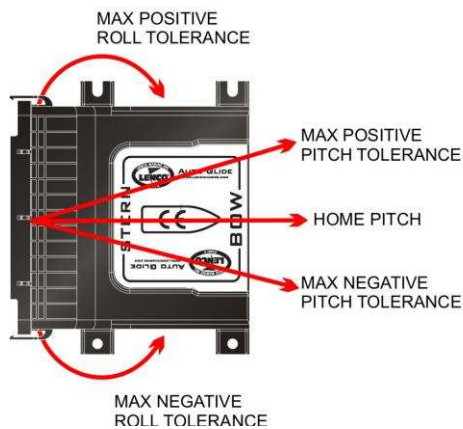

IF THE AUTO GLIDE SENSES THAT EITHER THE PITCH OR ROLL ANGLES EXCEED THEIR MAX TOLERANCE FOR MORE THAN 10 SECONDS, AN **OUT OF OPERATIONAL TOLERANCE MESSAGE** WILL FLASH ON THE KEYPAD.

ALL OF **AUTOMATIC SETTING LED INDICATORS** FLASH AND ALL AVAILABLE DATA QUADRANTS SCROLL ON THE CROSSHAIR LED INDICATORS DURING AN **OUT OF OPERATIONAL TOLERANCE MESSAGE**

Once the Auto Glide defaults to **LIMP HOME MODE** and displays an **OUT OF OPERATIONAL TOLERANCE FAILURE MESSAGE**, you will have to verify the Auto Glide Control Box is installed properly (See Section 2.3 in Owner’s Manual A) and then reset the Auto Glide by turning your motor(s) “OFF” then “ON” again.