

Part No 66000766

Pro-Series /Fish Rope Guard and Control Arm Upgrade Kit

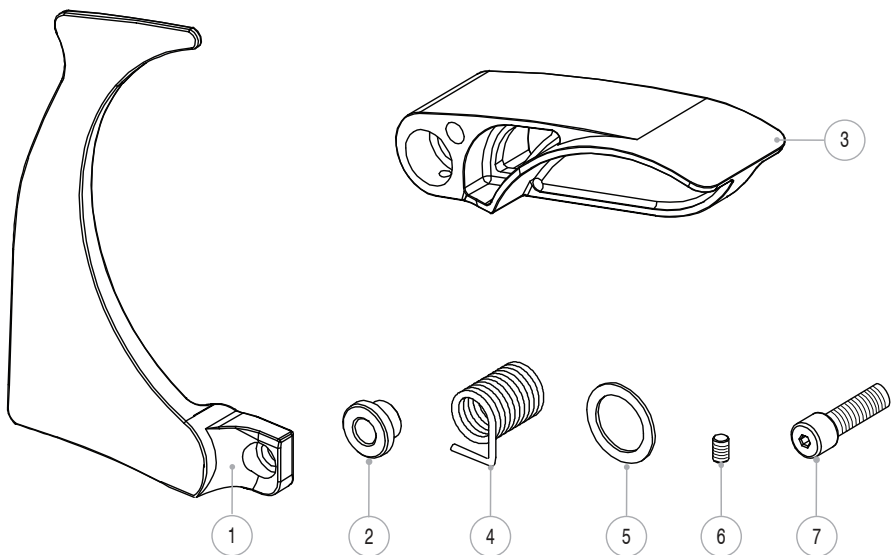

Kit contains the following:

1. Rope guard
2. Guard spacer
3. Control arm
4. Torsion spring
5. Pivot pin washer
6. Grub screw
7. Cap screw M6 x 20mm

Tools required

- 2 mm (5/64") Allen key
- 4 mm (5/32") Allen key
- 6 mm (15/64") Allen key
- Pro-Series clutch spanner
- Screw fixing compound

Note: Illustration based on the Pro-Series



Remove gypsy, cone and drive pins using clutch nut spanner and Allen key for the stripper screws.

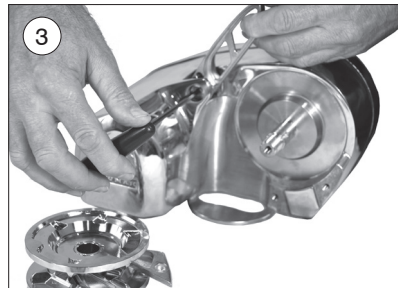
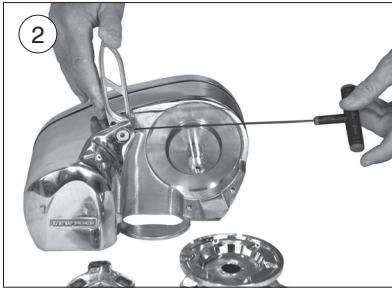
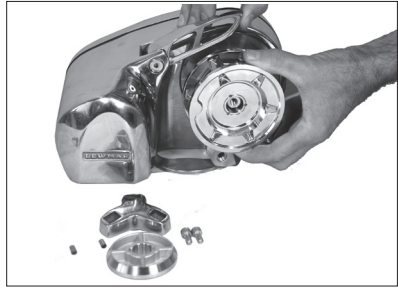

Raise the control arm and remove the grub screw located at the base of the arm using the 2mm (5/64") Allen key. This is fixed with loctite, gentle heat will aid removal.

Using the 4mm(5/32") Allen key, push and turn locating pin clockwise, then withdraw the pin outwards. The arm and washer can then be removed.

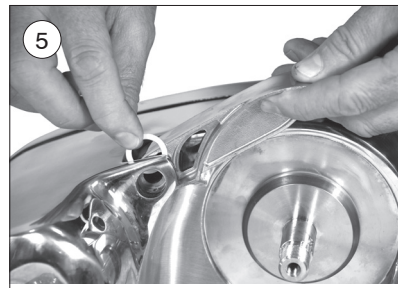

Fit new torsion spring

Fit new arm and washer.

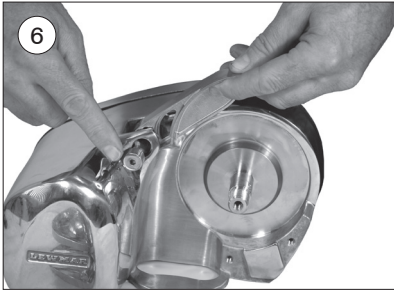

Replace pin by using the 4 mm (5/32") Allen key, push and rotate pin anticlockwise. The pin should then spring out and locate.

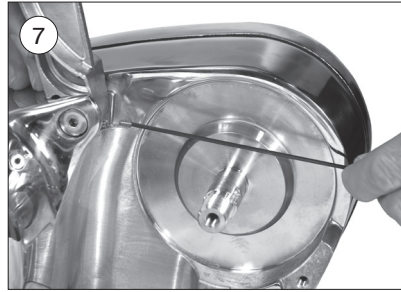

Replace grub screw using fastening compound.

8 Replace gypsy, drive pins and clutch nut, tighten using clutch nut spanner.



Fit spacer as shown.

NOTE : Spacer not required on Pro-Fish models

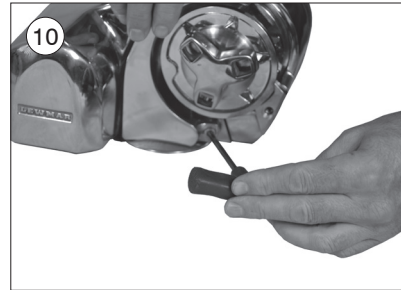

Place rope guard in place and secure using M6 x 20 screw and fastening compound.



The new rope guard and control arm kit is fitted

UK & International Distribution

Lewmar / Navtec
Southmoor Lane
Havant
Hampshire
PO9 1JJ
England

Tel: +44 (0)23 9247 1841

Fax: +44 (0)23 9248 5720

Email: info@lewmar.com

USA

Lewmar / Navtec
351 New Whitfield Street
Guilford, CT
06437
USA

Tel: +1 203 458 6200

Fax: +1 203 453 5669

Email: info@lewmarusa.com

www.lewmar.com

Manual Part No : B10413 Issue 3