

# Installing the AirVent 500

To install the AirVent 500 follow the instructions below. Follow steps one and two for marking and cutting the hole. Follow step three only if you are installing the interior trim ring. The AirVent 500 does not come with the 3" interior trim ring. If you wish to install the interior trim ring, it must be purchased separately (#N10866). Follow step four to install the vent unit into the installation hole.

1. Make sure the base of the vent is properly caulked when fastening it to the deck or hatch. We recommend using 1/4" to 1/2" (7mm–12mm) wide bead of silicone sealant.
2. The installation hole must be cut to 3-3/4" (95mm) in diameter so that the surface around the vent base is not distorted and the interior trim ring will fit. Measure carefully to cut the 3-3/4" (95mm) hole.
3. When installing the vent on a cambered surface, make sure you do not tighten the fasteners too much; this will distort the base of the vent and may cause the vent to leak.

### **VERY CRITICAL: DECK CAMBER (or deck curvature)**

When installing the MiniVent 1000 on a cambered, or curved, surface, it is critical to check to make sure there is no more than 1/2" (12mm) of camber over a 12" (300mm) length of deck surface. Too much camber will distort the base of the unit, causing the cover to be raised off the deck. This creates the potential for water to get under the cover and may also prevent the damper from closing properly.

**To check for camber, place a 12" (300mm) straight edge on the deck location for the vent and try to rock it. Then rotate it 90 degrees and repeat.**

The AirVent 500 features a built-in shut-off damper. The damper operates from below by sliding the damper out to open or sliding it in to close.

The AirVent 500's translucent center allows light to pass below.

An optional Nicro stainless steel cover (#N28830) is available for the AirVent 500. It attaches directly over the top of the vent with three #6 self-tapping screws. When installing the stainless steel cover, be sure to align the drain holes in the cover with those in the vent.

**DO NOT install the AirVent 500 in an area with more than 1/2" of camber over a 12" length of deck surface.**

### **PROBLEM AREAS TO AVOID**

Cut the hole for your MiniVent 1000 only after carefully considering the location and the correct sizing of the hole. We recommend that you **MEASURE TWICE AND CUT ONCE!**

DO NOT install the MiniVent 1000 in an area with more than 1/2" of camber over a 12" length of deck surface.

Be careful that the location you select for the through-deck hole does not go through any electrical wiring, plumbing or other obstructions. Be sure power tools are properly grounded.

**Take the time to bed the vent base and fasteners properly with sealant.**

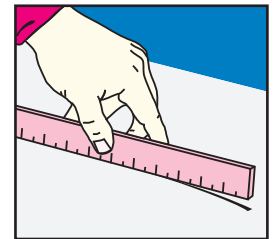
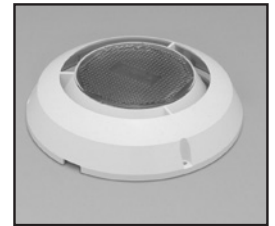

(Optional interior trim ring #N10866)

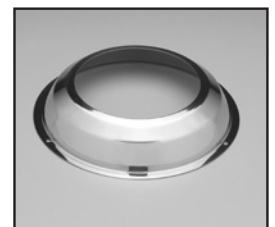

(Optional stainless steel cover ring #N28830)

## INSTALLING The MiniVent 1000 IN A HATCH OR THROUGH THE DECK

### STEP ONE: MARKING THE HOLE

When mounting on a deck, make sure to check the camber of the deck. See Precautions.

Carefully choose the installation location. If a hole saw is to be used, simply mark the center of the installation spot with an "X" for the pilot bit to penetrate. If a saber saw is to be used, scribe the circumference of the hole with a compass or trace the outline of the outside edge of the trim ring.

**NOTE:** The MiniVent 1000 requires a 3-3/4" (95mm) diameter hole.

**TIP:** If you are installing the MiniVent 1000 using the saber saw method and are concerned about scratching the deck or hatch with the base plate of the saw follow this tip: Select your installation location and, before scribing the circumference, cover the entire area with wide masking tape. Scribe the circumference on top of the tape. The tape will protect the installation surface while you are cutting the hole.

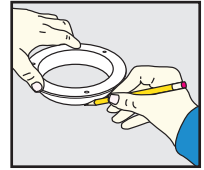
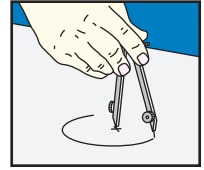

### STEP TWO: CUTTING THE HOLE

#### Using a Hole Saw

If you are cutting the hole with a hole saw, we recommend the use of a variable speed drill. Cutting the hole at a lower RPM will ensure that the hole is not cut too quickly, which can melt the plastic on a hatch. Follow the directions for the drill motor itself and be sure it is properly grounded. A slow, steady speed is preferred. Be sure to stop and clean out the hole and the hole saw periodically.

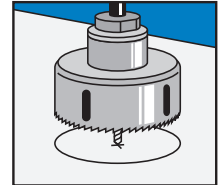

#### Using a Saber Saw

To cut the hole with a saber saw, select a blade that is compatible with the material you are cutting (fiberglass, wood, acrylic etc.). Be sure the saw is properly grounded. Drill a pilot hole near the inside edge of the scribed circumference that is big enough to insert the saw blade into. Insert the saw blade into the hole and slowly start cutting out to the scribed circumference. Cut carefully to avoid mistakes, breaking the blade, or melting the plastic on a hatch. Always cut right on your line or just outside of it.

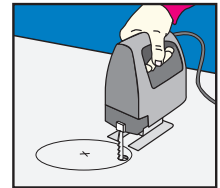

#### Finishing the Hole

Sand the edge of the hole smooth so that the trim ring and base plate fit properly. Test fit the entire unit. If the deck is cored with wood or foam, seal the exposed edge of the material with epoxy to prevent moisture from penetrating into the core.

**NOTE:** Most hatches are made of acrylic which is very durable. Even older acrylic is easy to cut and will not chip or crack as long as the proper tools and methods are used.

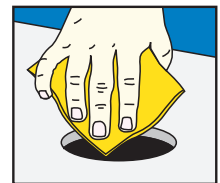

### STEP THREE: INSTALLING INTERIOR TRIM RING

#### Deck Mount

For decks having a thickness of 1" (25mm) or more, place the trim ring into the hole from the interior side and mark the three fastener holes. Remove trim ring and drill out the holes with a 5/32" bit. Place trim ring back into hole to ensure correct alignment. Fasten the trim ring into place with three #10x3/4" flat head screws provided. For decks having a thickness less than 1", the Nicro spacer ring (#N10863SP), or the trim ring can be left off. If desired, the Nicro soft vinyl protective ring (#N10863PR) can be installed with contact cement to cover the protruding portion of the fan housing.

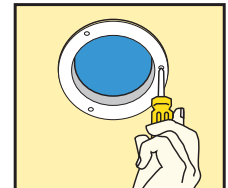

#### Hatch Mount

The interior trim ring can be left off for a hatch mount, or the Nicro soft vinyl protective ring (#N10863PR) can be pressed around the protruding portion of the fan housing. To install the interior trim ring on a hatch which is less than 1" (25mm) thick, the Nicro spacer ring (#N10863SP) is required.

**CAUTION:** Do not use the #10 flat head sheet metal screws to install the trim ring in an acrylic hatch as this may cause the hatch to crack.

**STEP FOUR: INSTALLING THE VENT UNIT**

It is important to rough up the bonding surfaces between the base of the unit and hatch or deck to get a good water-tight seal. Use 100 grit sandpaper around the edge of the installation hole and around the bottom of the unit.

**Deck Installation**

There are three drain holes on the vent base; one is larger than the other two and should be installed facing aft or towards the downward angle. It is labeled "AFT." Bed the base of the unit and the #6 pan head self-tapping screws provided with silicone or polyurethane sealant (regular silicone seal is recommended for flat surfaces and polyurethane for a cambered deck). Place the vent into the hole from the outside and attach it to the deck with the three #6 pan head self-tapping screws provided. **CAUTION:** Use shorter length screws if your deck is less than 5/8" (16mm) thick. **DO NOT** over-tighten the screws. Install the trim ring first, then the vent, using only a **HAND-HELD** screwdriver.

**Hatch Installation**

Fastener holes are not required for hatch installations if the vent is to be glued to the hatch with polyurethane. If fastener holes are to be used, drill 5/32" clearance holes completely through the material.

To glue the vent to a hatch, apply a generous bead of polyurethane bedding compound around the bottom of the vent. Rotate the vent into the hole as you are pressing it into place. This will insure a proper seal. Polyurethane needs to cure thoroughly for maximum strength; depending on the brand, this can take up to a few days. If you choose to use fasteners to install the vent, use #6 machine screws with a Nylock nut and washer (not provided). Drill three holes all the way through the acrylic hatch **OVERSIZED** to 5/32". Insert the machine screws all the way through the 5/32" holes. When silicone sealer is applied to the machine screws, the use of an oversized hole will create a shock absorber so the screws will not damage the hatch. Be sure to apply silicone sealer to the base of the unit and also to the machine screws so that the threads do not "weep" water below during wash down, rain or heavy spray.

Tighten the screws by hand (not a power-driver), and make them snug but not tight enough to crack the unit. Allow silicone to cure thoroughly to insure a watertight seal. **CAUTION:** Do not use the #6 pan head screws provided with this unit on a hatch installation as they may crack the hatch. Machine screws with clearance holes are required. Install the trim ring (and optional spacer) first, then the vent, using only a **HAND-HELD** screwdriver.

**FEATURES**

An optional Nicro stainless steel cover (#N28830) is available for the MiniVent 1000. It attaches directly over the top of the vent with three #6 self-tapping screws. When installing the stainless steel cover, be sure to align the drain holes in the cover with those in the vent.

The MiniVent 1000 comes with a removable insect screen that attaches to the shut-off damper. The screen is easy to install by grasping the fin in the center and carefully twisting it on in a clock-wise motion. The screen must be removed when opening the damper or you may break the tabs on the damper. If the shut-off damper becomes difficult to operate, apply a little silicone grease around the perimeter.

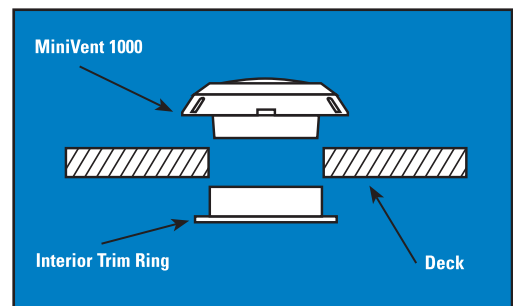
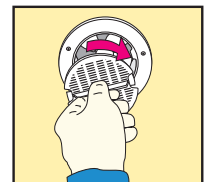
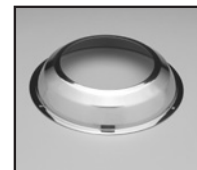
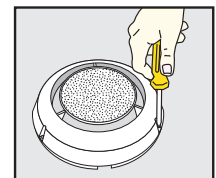
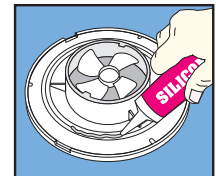
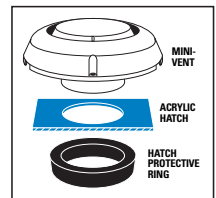
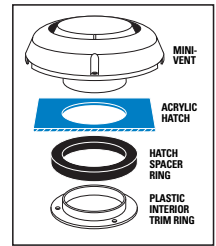

## **AirVent 500**

---

### **MAINTENANCE**

The fan blade should be cleaned periodically. To remove it for cleaning, gently pull it away from the motor. It will slide off the shaft. To replace the fan, simply push it back on to the motor shaft.

**CAUTION:** A straight pull or push of the blade should be exerted to ensure that you do not bend the motor shaft.

When replacing the fan blade be sure that the fan blade is not pressed against the motor housing, as this will cause the fan to bind and reduce performance. It is also recommended to periodically clean the solar array with a mild cleaner to ensure optimum performance.