

MUSTANG SURVIVAL



OWNER'S MANUAL

MD5183

ELITE™ INFLATABLE PFD

Hydrostatic Inflation Model
Manual with Automatic Backup

USCG Approvals:

Recreational: Type III

Uninspected Commercial Vessels: Type V



WE SAVE LIVES FOR A LIVING

DO NOT REMOVE PRIOR TO SALE

TABLE OF CONTENTS

APPROVAL CONDITIONS AND CARRIAGE REQUIREMENTS.....	1
Note to uninspected commercial vessel operators.....	1
Mandatory Carriage Requirements	2
INSTRUCTIONS FOR USE	3
Getting to know your PFD.....	3
Uninspected Commercial Vessel Use.....	4
Is your PFD in good and serviceable condition	4
PUTTING ON YOUR INFLATABLE PFD.....	5
INFLATING YOUR PFD	6
Automatically inflating your PFD.....	6
Manually inflating your PFD.....	6
Orally inflating your PFD.....	6
Deflating your PFD	7
RE-ARMING YOUR INFLATABLE PFD	8
RE-PACKING YOUR INFLATABLE PFD	11
USAGE BELOW FREEZING [32°F / 0°C].....	14
CARE AND MAINTENANCE INSTRUCTIONS.....	14
Inspecting your inflatable PFD.....	14
Servicing instructions for UCV operators.....	15
CLEANING AND STORING YOUR PFD.....	15
HOW AND WHY TO TEST YOUR PFD.....	16
How to test your PFD using the automatic inflator	16
How to test your PFD using the manual inflator	17
How to test your PFD using the oral inflation tube	17
WHY ARE PFDS REQUIRED SAFETY EQUIPMENT	18
WEAR YOUR PFD.....	18
THESE DEVICES ARE INTENDED TO HELP SAVE YOUR LIFE.....	19
HYPOTHERMIA	19
DO NOT ATTACH PFDS TO YOUR BOAT.....	21
ADDITIONAL INFORMATION.....	21

APPROVAL CONDITIONS AND CARRIAGE REQUIREMENTS

This inflatable PFD is approved by the U.S. Coast Guard for use as a Recreational Type III Personal Flotation Device (PFD) or a Commercial Type V (only when worn). It is not approved for water skiing or other high impact, high speed activities. This inflatable PFD was designed to be more comfortable and less restrictive to wear than inherently buoyant PFDs. When worn, used, and serviced according to this owner's manual, this PFD can greatly increase your chances of survival in the water. Not recommended for non-swimmers or weak swimmers. Users of inflatable PFDs must be at least 16 years old.

Conditions for Type V Approval in commercial applications

1. Must be worn before getting underway and whenever above deck and not within an enclosed space to meet the carriage requirement.
2. The operator of an uninspected commercial vessel is responsible for servicing and maintaining the PFD in good serviceable condition in accordance with this owner's manual. See "Care and Maintenance Instructions" on page 14 for servicing information.
3. The operator of an uninspected commercial vessel is responsible for providing each person onboard with the safety information required for use of the MD5183. See "Instructions for Use" on page 3 for information.

Commercial – Model MD5183 is a U.S. Coast Guard approved Type V inflatable PFD, approved **ONLY WHEN WORN** for use on uninspected commercial vessels less than 40 feet in length not carrying passengers for hire as a substitute for a Type III PFD when used in accordance with this owner's manual.

NOTE TO UNINSPECTED COMMERCIAL VESSEL OPERATORS

The operator of the vessel is required to provide the following User Information to each person on board during a passenger safety orientation (reference 46 CFR 122.506).

Inflatable PFD's will not provide any buoyancy without being inflated. Follow these instructions to be sure your PFD is armed and donned correctly, and that you understand how to inflate the device.

Basic Visual Examination – See "Inspecting your Inflatable PFD - Before Each Use" on page 14.

Inflation System and CO₂ Cylinder Check – See "Inspecting your Inflatable PFD - Before Each Use" on page 14.

Donning Instructions – See "Putting on your Inflatable PFD" on page 5.

Inflation Instructions – See "Inflating your PFD" on page 6.

Other Use Guidelines:

1. Always wear your PFD when underway unless you are inside a cabin. This is a requirement for commercial approval and is strongly advised for all users.
2. If you need to jump from any height, always fold arms over your chest to keep the PFD in place when entering the water.
3. Avoid all unnecessary activities that will be abrasive to the device.
4. Use extreme caution around sharp objects.
5. Avoid unnecessary exposure to the sunlight (see "Cleaning and Storing your PFD" on page 15).
6. CO₂ gas from cylinder will permeate through the chamber fabric over time. If you are in the water for a long time, it may be necessary to orally inflate the inflatable PFD until firm, by blowing air into the oral tube.
7. Inflatable PFDs are not designed for activities in which the wearer expects to encounter impact with the water at a high speed such as water skiing, riding personal watercraft, etc.
8. Inflatable PFDs are not designed for white water activities.
9. Dropping this PFD into the water will result in an inadvertent inflation.

MANDATORY CARRIAGE REQUIREMENTS:

Federal regulations in 33 CFR 175-1993 require you to carry Coast Guard approved personal flotation devices (PFDs) legibly marked with the Coast Guard approval number which are in good and serviceable condition and are the correct size for each person on board. To be considered serviceable, this PFD shall not exhibit deterioration that could diminish its performance such as broken or deformed hardware, detached webbing, rotted structural components, air leaks, or non-functional oral inflation tube. Unless worn, this PFD must also be properly armed with a full CO₂ cylinder, inflation system status indicator, and an accessible manual inflation lanyard. A PFD which is

FIG. 1

ELITE INFLATABLE PFD

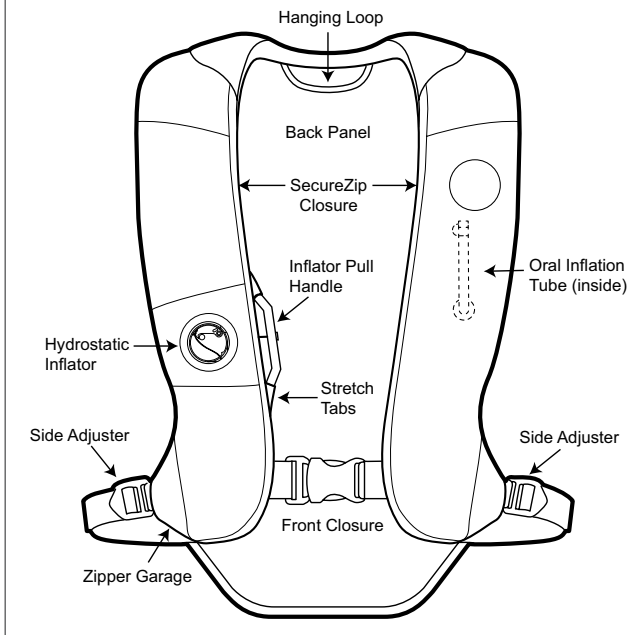

"approved only when worn" or "required to be worn" must be worn under the specified conditions.

INSTRUCTIONS FOR USE

GETTING TO KNOW YOUR PFD

As with any safety equipment, it is important to take the time to get to know your new PFD. Practice putting on your PFD, familiarize yourself with re-arming and repacking, and know how it will perform.

To create buoyancy in your PFD, it can be inflated with either CO₂ gas using the inflator, or can be inflated with air using the oral tube. Inflating your PFD with CO₂ can happen either automatically when you fall into the water, or manually by using the pull handle. The advantage of inflating with CO₂ is that it is quick and does not require a lot of effort from the wearer. The disadvantage is that you need to

re-arm your PFD before you can inflate it with CO₂ again (see "Re-Arming your inflatable PFD" on page 8).

Inflating your PFD with air is done by blowing air into the oral inflation tube. The advantage of inflating your PFD this way is that you do not need to re-arm your PFD when you are finished using it. The disadvantages are that it takes longer to inflate your PFD, and you are at risk of double inflation. For details on double inflation see page 6.

For instructions on inflating your PFD (see "Inflating your PFD" on page 6). It is important to check the inflator on your PFD on a regular basis to make sure that it is ready to go in case you need it. You can easily tell if the inflator is ready to go by checking the Status Indicator (Fig. 2). If it's green, your CO₂ cylinder is full and your PFD is properly armed. If it's red, the CO₂ cylinder is empty and your PFD needs to be re-armed (see "Re-Arming your inflatable PFD" on page 8).

UNINSPECTED COMMERCIAL VESSEL USE

This inflatable PFD is not approved for "hot work" and care must be taken to avoid damage from abrasion and sharp objects.

IS YOUR PFD IN GOOD AND SERVICEABLE CONDITION?

Check your PFD between outings to be sure that it is properly armed; that it is free of rips, tears or holes; that all seams are securely sewn; and that the fabric, straps and hardware are still strong. Inspect the inflatable portion of your PFD in accordance with the Care and Maintenance Instructions (see "Care and Maintenance Instructions" on page 14).

FIG. 2

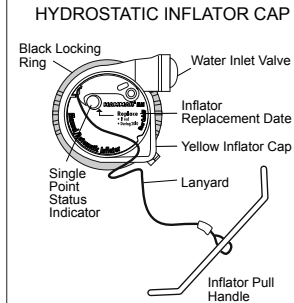

PUTTING ON YOUR INFLATABLE PFD

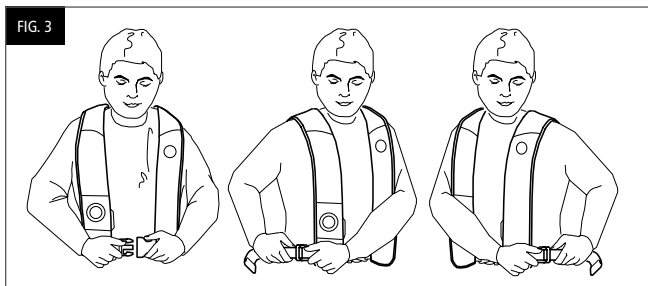

It is important that your inflatable PFD is properly adjusted to fit your body shape. An incorrect fit could result in poor performance. All belts and straps are already threaded correctly and only need to be adjusted to a tight personal fit.

10. Put the inflatable PFD on just like a jacket, and then fasten the front buckle (Fig. 3).
11. Adjust the left and right waist belt one at a time by pulling the free ends of the webbing upwards and towards your back.
12. Continue to equally adjust the left and right waist belts until there is no slack in the webbing, and there is no movement of the PFD on your body.
13. To ensure your PFD is tight enough, pinch each side of the waist belt. If you can pinch the waist belt together (Fig. 4), it is not tight enough. Continue to adjust the left and right waist belts.

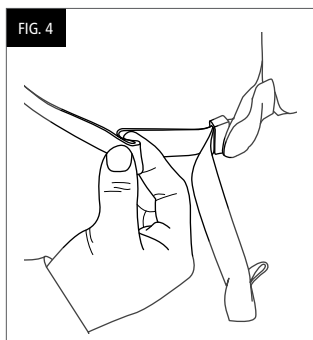

IMPORTANT: Do not wear inflatable PFDs under clothing as the inflation could be restricted or you could be injured.

INFLATING YOUR PFD

AUTOMATICALLY INFLATING YOUR PFD

Automatic inflation will occur when the inflator is submerged in more than 4 inches in the water.

MANUALLY INFLATING YOUR PFD

To manually activate the inflation system, firmly grasp the pull handle (Fig. 5) and quickly pull away from the body until the inflator activates.

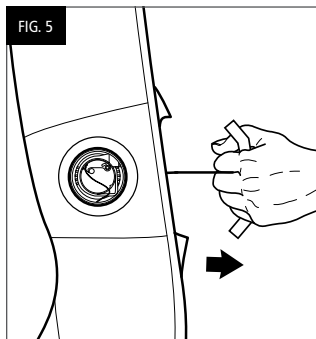

ORALLY INFLATING YOUR PFD

To orally inflate your PFD, first access the oral inflation tube by opening the cover on your left side, starting at the top. Grasp the tube, pull it towards your mouth, and blow into the tube to inflate (Fig. 6). A valve will automatically open and close during inflation to prevent air leakage

IMPORTANT: DOUBLE INFLATION

DO NOT MANUALLY ACTIVATE THE INFLATOR WHEN YOUR PFD IS FILLED WITH AIR. Doing so will result in excessively high pressure within the inflation chamber, which may cause permanent damage. When your PFD is completely filled with air, the inflator may not automatically inflate when exposed to water.

DEFLATING YOUR PFD

1. To deflate your inflatable PFD, reverse the oral inflation tube dust cap and insert it into the valve (Fig. 8). The dust cap will not lock the valve in the deflate position so it is necessary to hold it in place.
2. Gently squeeze your inflatable PFD until all air or CO₂ has been expelled.
3. Return the oral inflation tube dust cap to its stowed position on the oral inflation tube (Fig. 8).

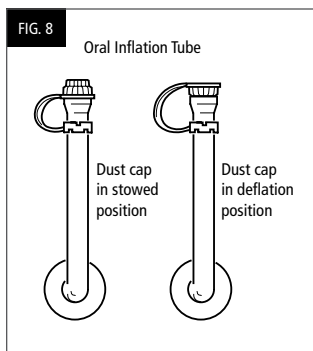
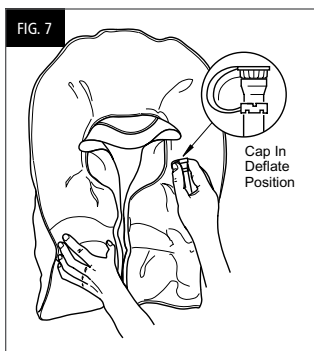

RE-ARMING YOUR INFLATABLE PFD

To re-arm your PFD, you will need Mustang Survival's Re-Arm Kit MA5183, which includes the Inflator Removal Key (A), the Inflator Body & Cylinder (B), and the Inflator Cap & Pull Handle (C) (Fig. 9).

1. Check that the status indicator is green on both the cap and body. If not green, you will be unable to re-arm.
2. Place your PFD on a flat surface so that the inflator is facing up and wipe off any water. Pass the pull handle back through the button hole so it is on the same side as the inflator.
3. Insert the Inflator Removal Key between the yellow inflator cap and the black locking ring (Fig. 10), and turn counter clockwise. The black ring will rotate counter clockwise behind the yellow inflator cap (Fig. 11).
4. Turn the black locking ring fully counter clockwise and pull the inflator cap off the bladder (Fig. 12, Fig. 13). Discard.
5. Squeeze the sealing ring to elongate and remove the black inflator body and cylinder from inside the bladder (Fig. 14). Discard (Fig. 15).

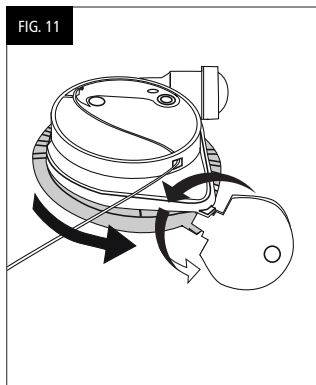
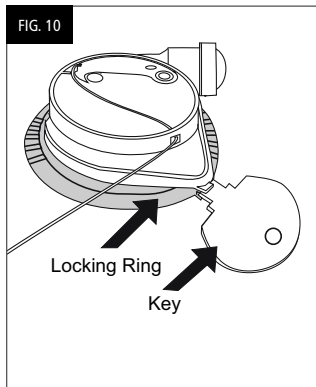
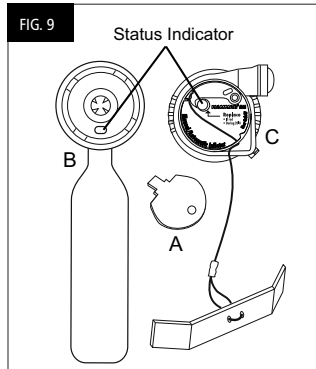

FIG. 12

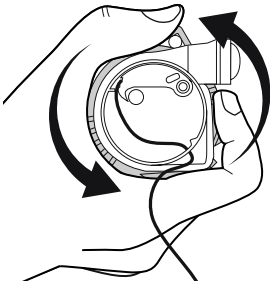

FIG. 13

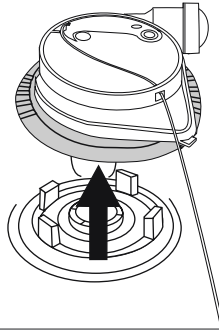

FIG. 14

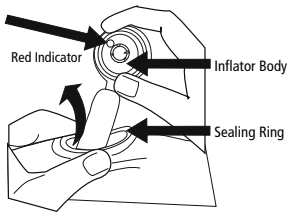

FIG. 15

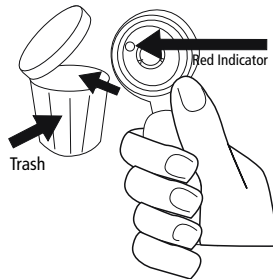

FIG. 16

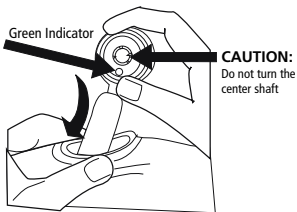
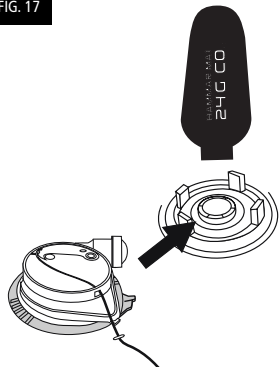

FIG. 17



6. Check that the new inflator body indicator is green. Insert the black inflator body and cylinder into the bladder (Fig. 16). Align the cylinder with the outline printed on the bladder (Fig. 17). Ensure that the inflator body is evenly contacting the sealing ring.

7. Check that the new inflator cap has a green status indicator and that the expiry date is ok. If indicator is red or expiry date is not ok, get a new re-arm kit.

8. While holding the CO₂ cylinder through the bladder fabric, align the new inflator cap on the inflator body (Fig. 18) with the water inlet valve pointing to the right, press down FIRMLY, and rotate the BLACK locking ring clockwise behind the yellow inflator cap. The black ring will click into place (Fig. 19). Pull on the cap to ensure that it is securely locked into the inflator body.

9. Pass the inflator pull handle through the button hole, and secure the ends into the stretch tabs (Fig. 20), taking care not to pull the lanyard and inadvertently inflate your PFD.

10. Repack your PFD (see "Re-Packing your inflatable PFD" on page 11).

FIG. 18

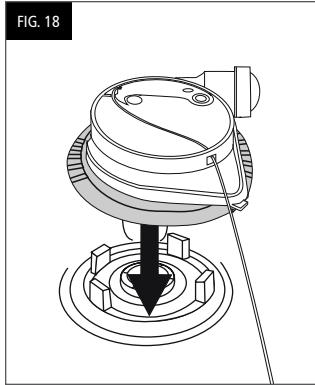

FIG. 19

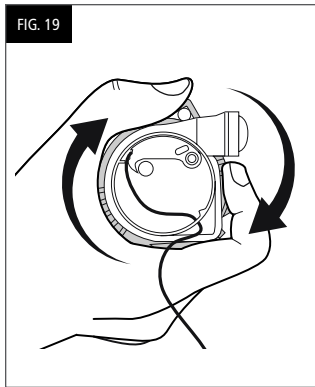
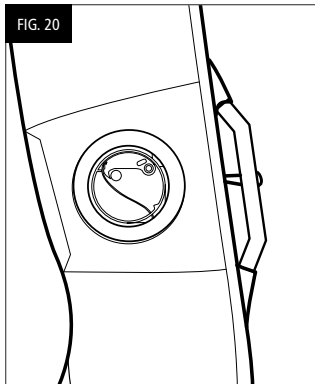

FIG. 20



RE-PACKING YOUR INFLATABLE PFD

Before repacking your PFD, and especially after re-arming, make sure there is no residual air in the bladder. It is important that all of the air has been removed from the bladder, or you may have difficulties properly packing your PFD (see "Deflating your PFD" on page 7). In extreme cases, performance may be affected.

1. Extend both sides of the waist belt to the maximum position, and lay your PFD on a smooth, flat surface (Fig. 21).
2. Starting on the side with the inflator, fold the outside edge in towards the middle so that the curves at the neck meet (Fig. 22).
3. Fold the inside edge back towards the outside of the PFD, so that the inflator is now sitting on top (Fig. 23). Pass the pull handle through the button hole and secure the ends in the stretch tabs.
4. Fold the outer cover over the bladder, and secure the top with the Velcro tabs (Fig. 24).
5. Fold the bottom edge of the bladder up (Fig. 25).

FIG. 21

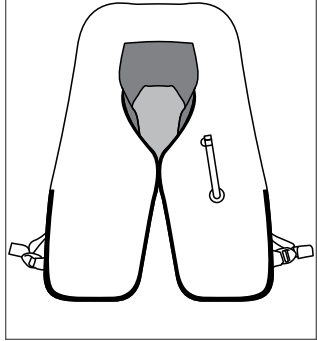

FIG. 22

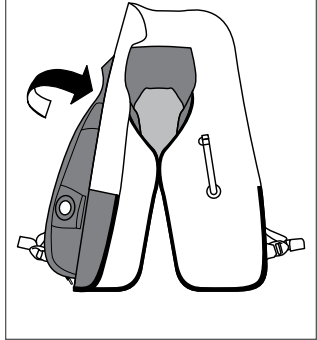
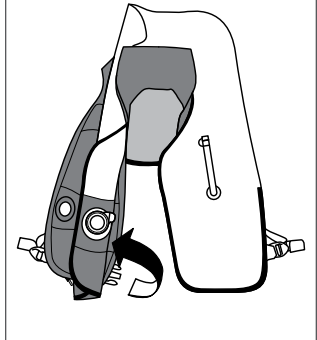

FIG. 23



6. Reset the zipper by pulling the slider from the zipper garage to the top of the zipper, and close the zipper by returning the slider to the bottom and tucking into the zipper garage (Fig. 26).
7. Repeat steps 2-6 on the left side (Fig. 27).
8. Fold the top edge of the bladder down once (Fig. 28), tuck corners under the cover, and fold the sides over (Fig. 29). Fold the cover flap down and secure with Velcro strip (Fig. 30).
9. Ensure pull handle ends are secured into the stretch tabs (Fig. 31), and ensure that the single point status indicator on the inflator cap is visible through the window.

FIG. 24

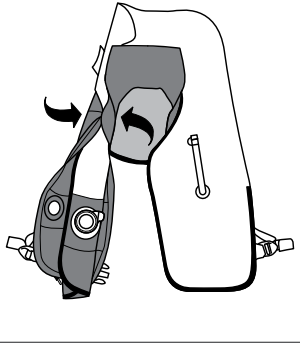

FIG. 25

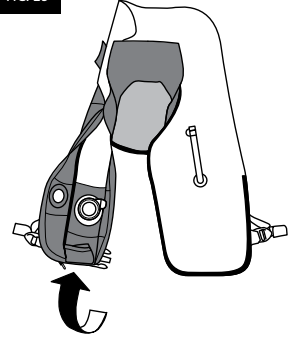

FIG. 26

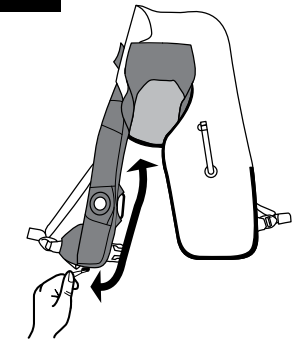

FIG. 27

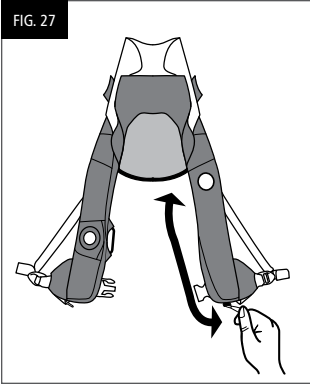

FIG. 28

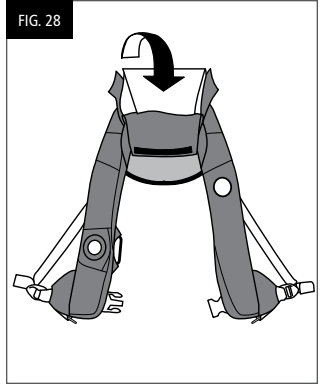

FIG. 29

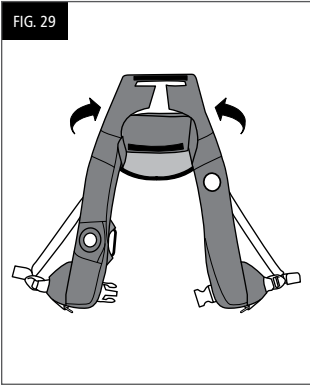

FIG. 30

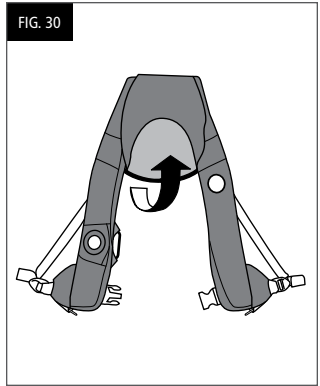

FIG. 31

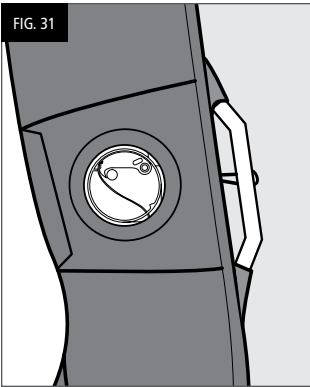
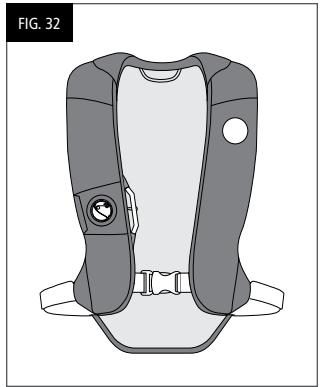

FIG. 32



USAGE BELOW FREEZING [32°F / 0°C]

If you choose to use your PFD below freezing, performance will not be as expected. Below freezing, a discharged cylinder may not fully inflate your PFD to the intended pressure. You will need to rely on your back up oral inflation system to adjust the internal pressure to achieve adequate buoyancy (see "Orally inflating your PFD" on page 6).

CARE AND MAINTENANCE INSTRUCTIONS

It is important to care for and maintain your inflatable PFD in order to ensure it will perform as designed when you need it. To keep a record of the inspections performed on your PFD, use the label provided under the back flap. If you are not confident in the self-inspection and servicing of your inflatable PFD in accordance with these instructions, contact Mustang Survival customer service.

INSPECTING YOUR INFLATABLE PFD

Before Each Use:

- Examine the single point status indicator ensuring it is green. If the indicator is red, your PFD needs to be re-armed (see "Re-Arming your inflatable PFD" on page 8).
- Ensure the manual pull-handle is properly stowed in the stretch tabs.
- Visually examine your inflatable PFD for damage or excessive abrasion, wear, tear and/or contamination. If any item shows signs of damage, perform tasks listed in "Every Six (6) Months" inspection details.

Every Six (6) Months:

In addition to the inspections specified for before each use, perform the following at least every 6 months, or more often if exposed to potential damage or used in extreme conditions.

- Leak Test: Your Inflatable PFD should be tested for leakage by inflating with air until firm and leaving it to stand for at least 2 hours in a temperature controlled environment. A leaking Inflatable PFD will not remain firm and should be replaced. If your Inflatable PFD leaks, contact Mustang Survival customer service.

Annually:

In addition to the inspections specified for every six months, perform the following at the beginning of each boating season or whenever the integrity of your inflatable PFD is in doubt:

- Thoroughly check all components for dirt and/or corrosion. Clean or replace, as necessary. If any item shows signs of damage, perform inspections listed in "Every Six (6) Months" inspection details. If in doubt, contact Mustang Survival customer service.
- Ensure the current date is not past the date on the inflator. If it is, replace the inflator (see "Re-Arming your inflatable PFD" on page 8).

SERVICING INSTRUCTIONS FOR UCV OPERATORS

It is the responsibility of the operator to be sure this PFD is in serviceable condition. Reference Mandatory Carriage Requirements on page 2. This PFD must also be properly armed with status indicator showing Green on both the inflator cap and body. (see "Re-Arming your inflatable PFD" on page 8).

CLEANING AND STORING YOUR PFD

To clean your inflatable PFD, hand wash or sponge down in warm, soapy water, taking care not to submerge the inflator. Rinse your PFD with clean water, and hang to dry on a plastic coat hanger. Do not dry-clean, use chlorine bleach, or apply direct heat. Always store your fully dried PFD in a warm, dry, well ventilated place out of direct sunlight.

HOW AND WHY TO TEST YOUR PFD

Inflate your PFD and try it out in the water to:

1. Make sure it floats you:
 - Comfortably (When worn properly)
 - Adequately for expected wave conditions (Body shapes/densities affect performance)
2. Make sure it works:
 - A flow of bubbles should not appear (see "Inspecting your inflatable PFD" on page 14 for leak tests)
 - It should inflate quickly and easily
3. Learn how it works by:
 - Activating the CO₂ inflation system
 - Rearming the CO₂ inflation system
 - Using the Oral inflation tube

The U.S. Coast Guard recommends that you purchase two rearming kits; one to be used immediately in testing the automatic inflation system (see "How to test your PFD using the automatic inflator" on page 16) and the other to carry onboard as a spare.

HOW TO TEST YOUR PFD USING THE AUTOMATIC INFLATOR

1. To test your inflatable PFD using automatic inflation, you will need your fully armed PFD, and the re-arming kit (MA5183) approved for your PFD.
2. Put on your PFD.
3. Get into shallow water, just deep enough that you can stand with your head above the surface. Once the inflator is under water your PFD should automatically fully inflate within 10 seconds.
4. See if your PFD will float you on your back or just slightly back of vertical. In a relaxed floating position, verify that your mouth is well above the water's surface. Note the effect of where you hold your legs on how you float.
5. Get out of the water and remove your PFD. Deflate the PFD using the oral inflator (see "Deflating your PFD" on page 7).
6. Let your PFD dry thoroughly, Re-arm (page 8), and Repack (page 11) your PFD.

HOW TO TEST YOUR PFD USING THE MANUAL INFLATOR

1. To test your inflatable PFD using manual inflation, you will need your fully armed PFD, and the re-arming kit (MA5183) approved for your PFD.
2. Put on your PFD.
3. Actuate the inflation system by jerking firmly on the pull handle. Your PFD should fully inflate within 5 seconds.
4. Get into shallow water, just deep enough that you can stand with your head above the surface.
5. See if your PFD will float you on your back or just slightly back of vertical. In a relaxed floating position, verify that your mouth is well above the water's surface. Note the effect of where you hold your legs on how you float.
6. Get out of the water and remove your PFD. Completely deflate the PFD using the oral inflator (see "Orally inflating your PFD" on page 6).
7. Let the PFD dry thoroughly, Re-arm (page 8), and Repack (page 11) the PFD.

HOW TO TEST YOUR PFD USING THE ORAL INFLATION TUBE

WARNING: Use only a previously fired hydrostatic inflator to perform this test. DO NOT test with a fully armed hydrostatic inflator as double inflation may occur, possibly resulting in damage to the PFD.

1. To test your inflatable PFD using oral inflation you will not need any spare parts, or rearming kits.
2. Put on your PFD.
3. Get into shallow water, just deep enough that you can stand with your head above the surface.
4. If you are a weak swimmer or non-swimmer, inflate the PFD partially so that you are supported well enough to be able to complete inflation without touching bottom, either orally or manually. Note this level of inflation because it is the minimum needed to safely use this inflatable PFD.
5. Fully inflate your PFD using the oral inflation tube.

6. See if your PFD will float you on your back or just slightly back of vertical. In a relaxed floating position, verify that your mouth is well above the water's surface. Note the effect of where you hold your legs on how you float.
7. Get out of the water and remove your PFD. Completely deflate the PFD using the oral inflator (see "Orally inflating your PFD" on page 6).
8. Let the PFD dry thoroughly, Re-arm (page 8), and Repack (page 11) the PFD.

WHY ARE PFDS REQUIRED SAFETY EQUIPMENT?

Drowning is the leading cause of fatality involving recreational boating. A PFD provides flotation to help keep your head above water, help you to stay face up in the water, and increase your chances for survival and rescue. Most adults only need an extra 7 to 12 pounds of flotation to keep their heads above water. The proper size PFD will properly support the weight of the wearer. Since this inflatable PFD does not have inherent buoyancy, it provides flotation only when inflated. Familiarize yourself with the use of this PFD so you know what to do in an emergency.

WEAR YOUR PFD

In approximately 80 percent of all boating fatalities, the victims were not wearing a PFD. Most fatal accidents happen on calm sunny days. This inflatable PFD is much more comfortable to wear than other PFD types. Get into the habit of wearing this PFD. Non-swimmers and children especially should wear a hybrid or non-inflatable PFD at all times when on or near the water.

THESE DEVICES ARE INTENDED TO HELP SAVE YOUR LIFE

For your PFD to function properly, follow these suggestions to verify that it fits, floats, and remains in good condition.

- Check the single point status indicator on the inflator before each use (see "Inspecting your inflatable PFD" on page 14).
- Re-arm your PFD immediately after each inflation (see "Re-Arming your inflatable PFD" on page 8).
- Try your PFD on and adjust it until it fits comfortably in and out of the water. (see "How and Why to Test your PFD" on page 16).
- Mark your PFD with your name if you are the only wearer.
- Do not alter your PFD. If it doesn't fit properly, get one that does. An altered device is no longer Coast Guard approved.
- Do not use your PFD as a fender or kneeling pad.
- If your PFD is wet, allow it to dry thoroughly before storing it. Store it in a warm, dry, well ventilated area.
- Do not dry your PFD with direct heat.

HYPOTHERMIA

Prolonged exposure to cold water causes a condition known as hypothermia – a substantial loss of body heat which leads to exhaustion and unconsciousness. Most drowning victims first suffer from hypothermia.

The following chart shows the effects of hypothermia:

Water Temperature °C (°F)	Exhaustion or Unconsciousness	Expected Time of Survival
0.3 (32.5)	Under 15 min.	Under 15–45 min.
0.3–4 (32.5–40)	15–30 min.	30–90 min.
4–10 (40–50)	30–60 min.	1–3 hrs
10–16 (50–60)	1–2 hrs.	1–6 hrs.
16–21 (60–70)	2–7 hrs.	2–40 hrs.
21–27 (70–80)	2–12 hrs.	3 hrs. to Indefinite
over 27 (over 80)	Indefinite	Indefinite

PFDs can increase survival time because they allow you to float without using energy treading water, and because of their insulating properties. Naturally, the warmer the water, the less insulation you will require. When operating in cold waters [below 60°F (15.6°C)] you should consider using a coat or jacket style PFD or a Type V Thermal Protective PFD as they cover more of the body than the vest or belt style PFDs.

Some Points to Remember About Hypothermia Protection:

1. Always wear your PFD. Even if you become incapacitated due to hypothermia, your PFD will keep you afloat, and greatly improve your chances of rescue.
2. Do not attempt to swim unless it is to reach a nearby craft, fellow survivor, or a floating object on which you can lean or climb. Swimming increases the rate of body heat loss. In cold water, drown-proofing methods that require putting your head in the water are not recommended. Keep your head out of the water. This will greatly lessen heat loss and increase your survival time.
3. Use the standard H.E.L.P. position (Heat Escape Lessening Position) when wearing an inflatable PFD, drawing the legs up to a seated position, because doing so will help you conserve body heat (Fig. 33).
4. Keep a positive attitude about your survival and rescue. This will improve your chances of extending your survival time until rescued. Your will-to-live does make a difference!
5. If there is more than one person in the water, huddling is recommended while waiting to be rescued. This action tends to reduce the rate of heat loss and thus increase the survival time.



DO NOT ATTACH PFD'S TO YOUR BOAT

Each PFD has straps, hooks, buckles, or other means for securing the device in place on the wearer. Some PFDs also incorporate decorative D-rings or tabs. Such items are not to be used to attach the device to the boat. Attaching the device to the boat will not permit it to perform as intended.

ADDITIONAL INFORMATION

If you need more information about PFDs and safe recreational boating, contact your state boating authority, U.S. Coast Guard Auxiliary, U.S. Power Squadron, Red Cross, or your nearest unit of the U.S. Coast Guard; or call the free boating course number 1-800-336-BOAT (in VA, 1-800-245-BOAT).

Mustang Survival has been providing lifesaving solutions for over 45 years. Through constant innovation and the application of new technologies, Mustang is the leading supplier of quality flotation and hypothermia protection products to the most demanding users — from fishermen, sailors and commercial mariners to the Coast Guard, fighter pilots and even NASA astronauts.



WE SAVE LIVES FOR A LIVING

mustangsurvival.com

TOLL FREE 1.800.526.0532 | EMAIL CUSTSERV@MUSTANGSURVIVAL.COM

Mustang Survival and seahorse design is a registered trademark of Mustang Survival ULC.

Our commitment to quality has earned our Burnaby facilities ISO 9001 registration, the highest of all international standards. This is our guarantee you're receiving the ultimate in design and manufacturing.

A BRAND OF THE SAFARILAND GROUP
©2014 Safariland, LLC 052813