

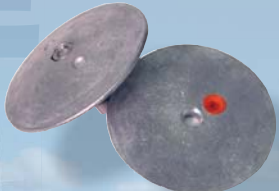

Aluminum Sacrificial Anodes

High Performance Aluminum Anodes

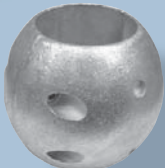
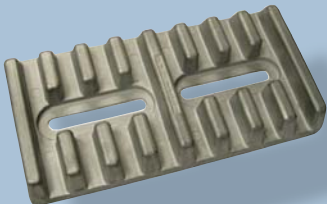

PERFORMANCE METALS



CORROSION CONTROL • NAVALLOY ANODES • RED SPOT WEAR INDICATOR • SECURECORE



# ALUMINUM ANODES

*A better solution for every application...*

Longer Lasting...



Navalloy® anodes will work longer than Zinc because they have more capacity for the same overall size:

Capacity per unit weight is:

Zinc	368 Ampere Hours/lb
Magnesium	500 Ampere Hours/lb
Navalloy®	1150 Ampere Hours/lb

But density is:

Zinc	0.25 lb/cu in
Magnesium	0.06 lb/cu in
Navalloy®	0.10 lb/cu

Therefore the relative life expressed in A Hours/ cu inch is:

Zinc	92 Ampere Hours/cu inch
Magnesium	30 Ampere Hours/cu inch
Navalloy®	115 Ampere Hours/cu inch

So Navalloy® anodes will last up to 30% longer than Zinc and up to 4x longer than Magnesium!

Any Hull...

	Aluminum	Steel	Fibreglass	Wood
Navalloy®	✓	✓	✓	✓

All Water Types...

	Salt	Brackish	Fresh
Zinc	✓		
Magnesium			✓
Navalloy®	✓	✓	✓

**ABYC** Navalloy® meets American Boat and Yacht Council requirements for use in all types of water.  
Boating Safety... Built In

Most outboard and sterndrive manufacturers now install Aluminum anodes as standard because they are safe and offer the best overall protection in any type of water.

Better Protection...

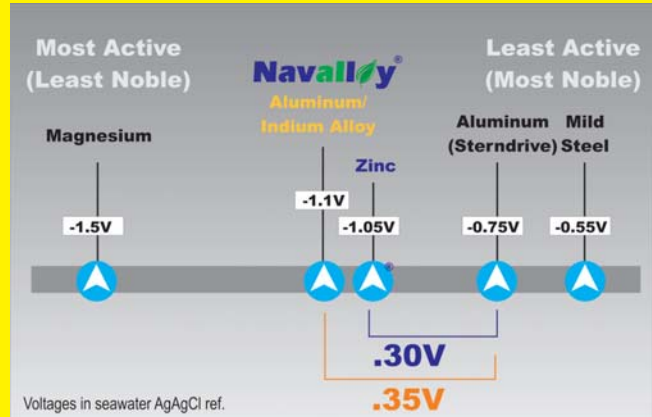

Navalloy® anodes work better than Zinc in saltwater because they generate a more negative voltage therefore providing increased protection. In freshwater Magnesium anodes can sometimes over-protect Aluminum hulls or outdrives. Navalloy® Mil. Spec. MIL-DTL-24779.

Any Kind of Use...

- Re-activates after exposure to air
- Works immediately on re-immersion
- No cleaning required

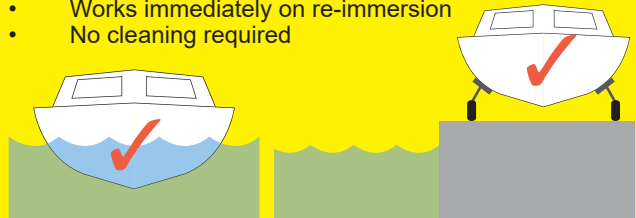

Navalloy® anodes can be left permanently immersed or can be used on boats that are regularly lifted in and out of the water (such as trailered boats, boats on lifts or boats left on the hard over winter). Zinc anodes will coat over if exposed to air and need to be burnished before re-immersion.

Exclusive RED SPOT Wear Indicator...

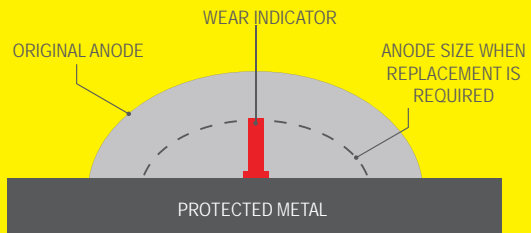

The patented red spot wear indicator is exclusive to Performance Metals Products. When the red spot appears it's time to change!

# ALUMINUM ANODES

**A better solution for every application...**

Eco-Friendly...

Why Use Navalloy?

Zinc anodes have 20 times more toxic elements

REDUCE POLLUTION!

Cadmium FREE

Mercury FREE

Navalloy® anodes are 20 times more eco-friendly than Zinc anodes. The EPA (Environmental Protection Agency) has identified Zinc anodes as a major cause of pollution in marinas and so now recommend the use of Aluminum anodes.

## Navalloy in Saltwater

### Key benefits over Zinc

- ✓ **Up to 30% longer lasting**
- ✓ **Increased protection**
- ✓ **20 times more eco-friendly**
- ✓ **Lighter weight**
- ✓ **Auto reactivating**

Lighter than Zinc...



Navalloy® anodes are lighter than Zinc which is 2 ½ times more dense than Aluminum.

## Navalloy in Freshwater

### Key benefits over Zinc

- ✓ **Up to 4 x longer lasting**
- ✓ **No risk of overprotection**

Zinc density                      0.25 lb/cu in (6.6gm/cc)  
 Aluminum density              0.10 lb/cu (2.8gm/cc)

Attractive Packaging...

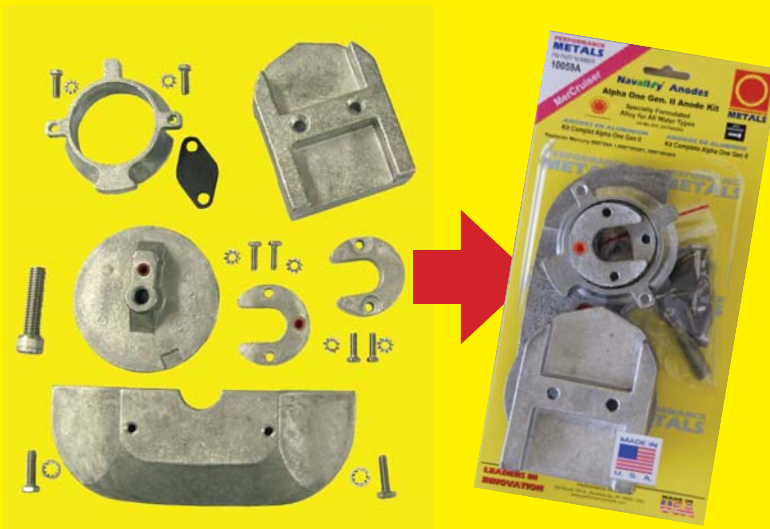

Navalloy® anodes are packaged attractively with printed text in multiple languages including installation instructions. In many cases they are available in complete kits for maximum convenience.

# BRP ANODE KITS

10188A

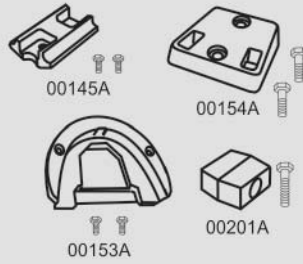

OMC Cobra Kit

Weight: 2.3 lbs (1.05 Kg)  
Pack Size: 5 1/2 x 11 x 2 3/4  
(140 x 279 x 70)



10189A

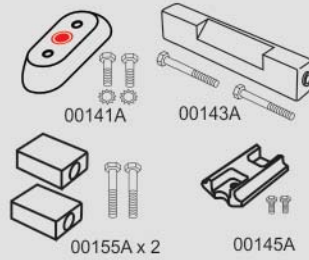

Johnson/Evinrude 50-225 hp  
(1991-1995)  
Weight: 1.9 lbs (0.9 Kg)  
Pack Size: 5 1/2 x 11 x 2 3/4  
(140 x 279 x 70)



10190A

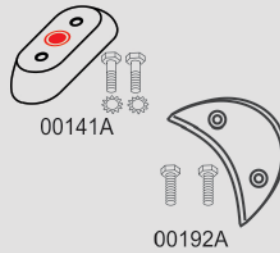

Johnson/Evinrude 90-225 hp  
(1985-1986)  
Weight: 1.2 lbs (0.6 Kg)  
Pack Size: 5 1/2 x 11 x 2 3/4  
(140 x 279 x 70)



10221A

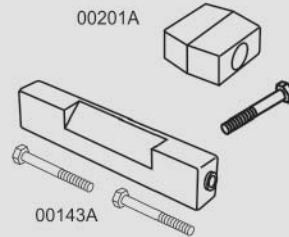

Johnson/Evinrude 50-225 hp  
(1991-1995)  
Weight: 1.3 lbs (0.6 Kg)  
Pack Size: 5 1/4 x 9 x 1 3/4  
(133 x 229 x 44)



10460A

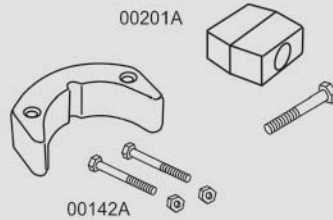

Johnson/Evinrude 50-75 hp  
(1991-1995)  
Weight: 1.3 lbs (0.6 Kg)  
Pack Size: 5 1/4 x 9 x 1 3/4  
(133 x 229 x 44)



10461A

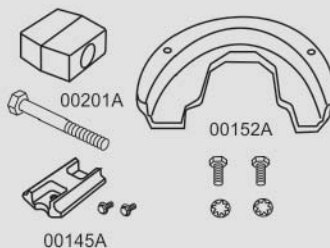

OMC Stringer  
Weight: 1.4 lbs (0.6 Kg)  
Pack Size: 5 1/4 x 9 x 1 3/4  
(133 x 229 x 44)



## BRP ANODE KITS

10462A

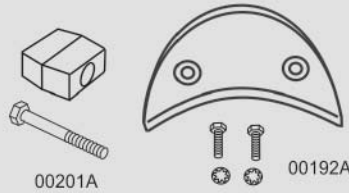

OMC V4-V6 Kit

Weight: 2.3 lbs (1.05 Kg)  
Pack Size: 5 1/2 x 11 x 2 3/4  
(140 x 279 x 70)



10463A

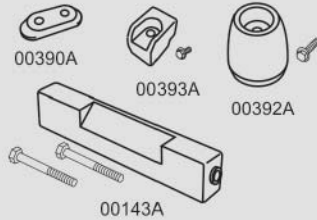

Evinrude ETEC-G2 Kit

Weight: 2.3 lbs (1.05 Kg)  
Pack Size: 5 1/2 x 11 x 2 3/4  
(140 x 279 x 70)



## BRP ANODES

00141A 

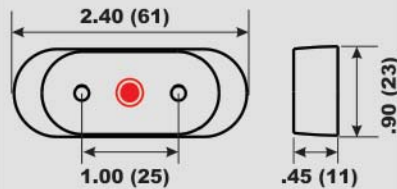

**Side Mounted**

Weight: 0.1 lbs (0.05 Kg)

Replaces J/E #s 123009/327606/173029



00142A

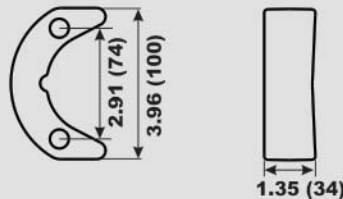

**Transom**

Weight: 0.7 lbs (0.3 Kg)

Replaces J/E # 392462



00143A

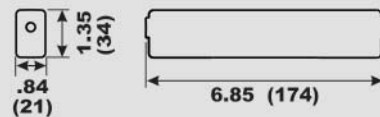

**Transom**

Weight: 0.7 lbs (0.3 Kg)

Replaces J/E # 433580



00144A

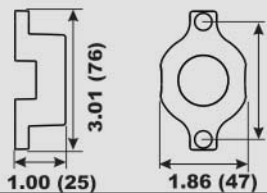

**Front Gearcase**

Weight: 0.15 lbs (0.07 Kg)

Replaces J/E # 398873



00145A

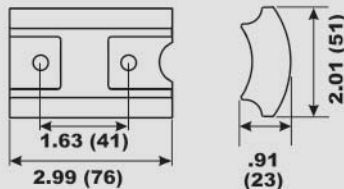











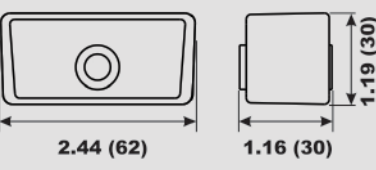

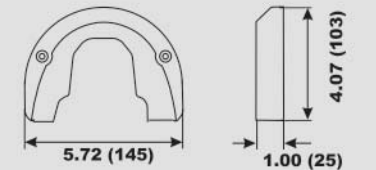

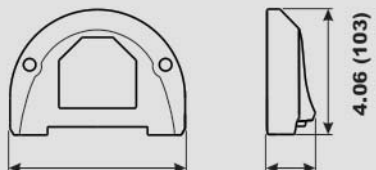

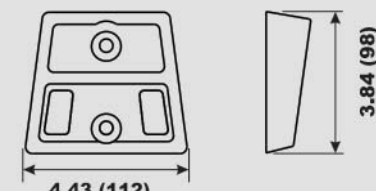
**Prop Shaft**

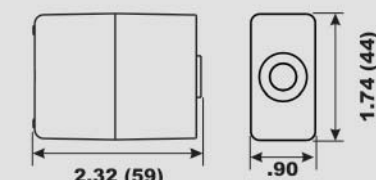
Weight: 0.2 lbs (0.08 Kg)

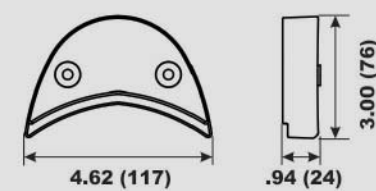
Replaces J/E # 431708

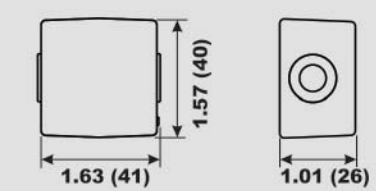

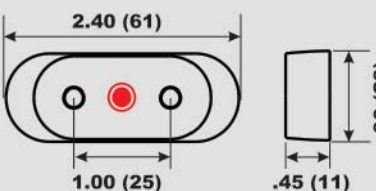
# BRP ANODES

<p>00151A</p> 		<p><b>Block</b></p> <p>Weight: 0.3 lbs (0.15 Kg)</p> <p>Replaces J/E # 397768</p>	
<p>00152A</p> 		<p><b>Front Gearcase Anode</b></p> <p>Weight: 0.6 lbs (0.28 Kg)</p> <p>Replaces J/E # 983494</p>	
<p>00153A</p> 		<p><b>Front Gearcase Anode</b></p> <p>Weight: 0.9 lbs (0.4 Kg)</p> <p>Replaces J/E #s 3853818/984513</p>	
<p>00154A</p> 		<p><b>Transom Mount</b></p> <p>Weight: 0.7 lbs (0.32 Kg)</p> <p>Replaces J/E # 984547</p>	
<p>00155A</p> 		<p><b>Block - Rear Gearcase</b></p> <p>Weight: 0.3 lbs (0.15 Kg)</p> <p>Replaces J/E #s 433458/398331</p>	
<p>00192A</p> 		<p><b>Front Gearcase</b></p> <p>Weight: 0.7 lbs (0.3 Kg)</p> <p>Replaces J/E # 392123</p>	
<p>00201A</p> 		<p><b>Cobra Rear Gear Case</b></p> <p>Weight: 0.2 lbs (0.1 Kg)</p> <p>Replaces J/E #s 436745/393023</p>	
<p>00390A</p> 		<p><b>Gearcase Anode</b></p> <p>Weight: 0.1 lbs (0.05 Kg)</p> <p>Replaces J/E #s 357507</p>	

## BRP ANODES

00392A

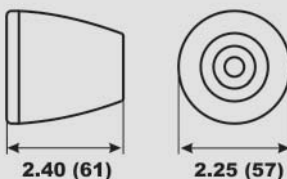

**Prop Anode**



Weight: 0.5 lbs (0.2 Kg)

Replaces J/E # 5009220

00393A

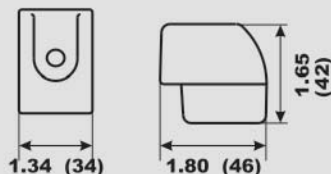

**Gearcase Anode**



Weight: 0.3 lbs (0.15 Kg)

Replaces J/E # 355964

00394A

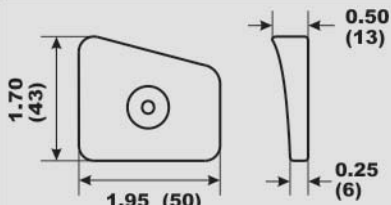

**Gearcase Anode 20-30hp**



Weight: 0.2 lbs (0.1 Kg)

Replaces J/E # 5007582/434029

## FLEX-O-FOLD ANODE

00685A

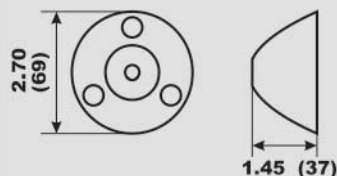

**Flex-O-Fold FX-112**



Weight: 0.5 lbs (0.23 Kg)

Replaces Flex # FX-112

## HONDA OUTBOARD KITS

10470A

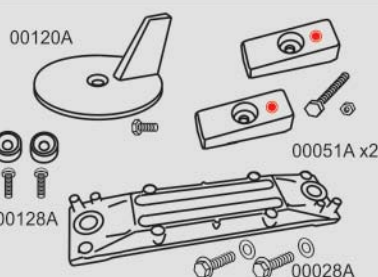

Honda 40-50 hp Kit  
Weight: 2.1 lbs (0.95 Kg)  
Pack Size: 5 ½ x 11 x 2 ¾  
(140 x 279 x 70)





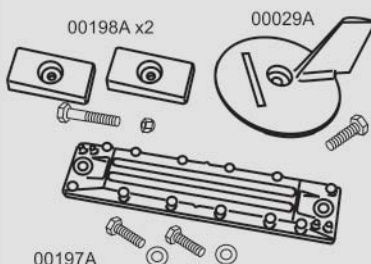







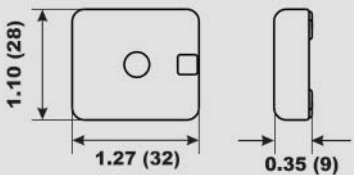

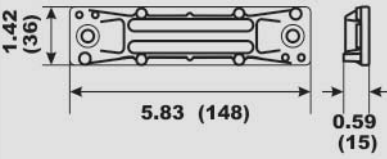

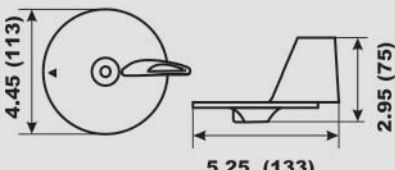



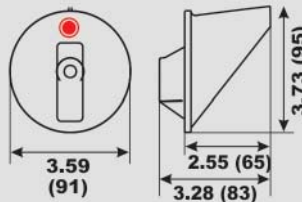

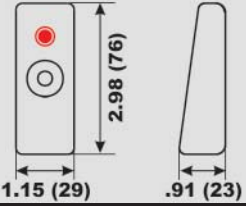

10471A

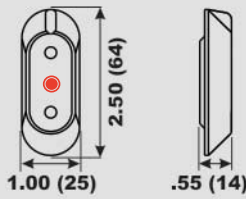

Honda BF Kit  
Weight: 2.3 lbs (1.0 Kg)  
Pack Size: 5 ½ x 11 ¾ x 2 ¾  
(140 x 298 x 70)

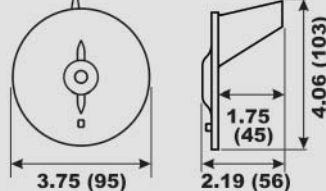

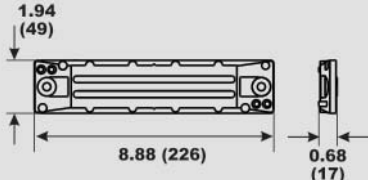
# HONDA ANODES

<p>00027A</p> 		<p><b>Small Plate Anode (2 per)</b> </p> <p>Weight: 0.1 lbs (0.05 Kg)</p> <p>Replaces Honda # 41106-ZW9-000</p>
<p>00028A</p> 		<p><b>Stern Bracket Anode</b> </p> <p>Weight: 0.4 lbs (0.2 Kg)</p> <p>Replaces Honda # 06411-ZV5-000,020</p>
<p>00029A</p> 		<p><b>Small Plate Anode (2 per)</b> </p> <p>Weight: 0.5 lbs (0.23 Kg)</p> <p>Replaces Honda # 41107-ZW1-B01ZA</p>
<p>00044A </p> 		<p><b>Trim Tab Anode</b> </p> <p>Weight: 0.4 lbs (0.17 Kg)</p> <p>Replaces Honda # 41107-ZW1-003ZA</p>
<p>00051A </p> 		<p><b>Side Pocket Anode</b> </p> <p>Weight: 0.18 lbs (0.08 Kg)</p> <p>Replaces Honda # 41109-ZW1-003</p>
<p>00119A </p> 		<p><b>Side Mounted</b> </p> <p>Weight: 0.1 lbs (0.05 Kg)</p> <p>Replaces Honda # 41106-935-812</p>
<p>00120A</p> 		<p><b>Trim Tab</b> </p> <p>Weight: 0.3 lbs (0.12 Kg)</p> <p>Replaces Honda # 41107-ZV5-000</p>
<p>00197A</p> 		<p><b>Stern Bracket</b> </p> <p>Weight: 0.7 lbs (0.3 Kg)</p> <p>Replaces Honda # 6411-ZW1-000/020</p>



# HONDA ANODES

00198A

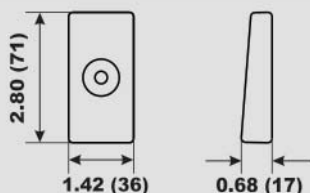

**Side Pocket Anode Thin**  
(2 per)  
Weight: 0.4 lbs (0.2 Kg)



Replaces Honda # 41109-ZW1-B00

# MERCUISER STERNDRIVE KITS

10108A

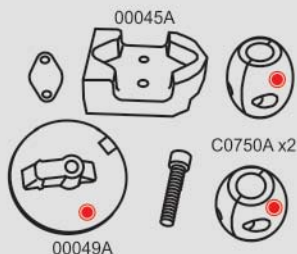

Alpha One Generation 1

Weight: 2.0 lbs (0.9 Kg)  
Pack Size: 5 1/2 x 11 x 2 3/4  
(140 x 279 x 70)



10059A

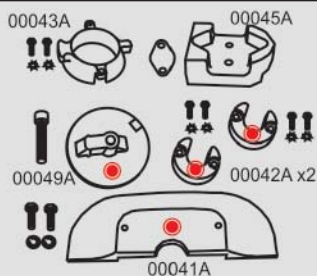

Alpha One Generation 2

Weight: 2.1 lbs (1.0 Kg)  
Replaces Mercury # 888756Q03  
Pack Size: 5 1/2 x 11 x 2 3/4  
(140 x 279 x 70)



10060A

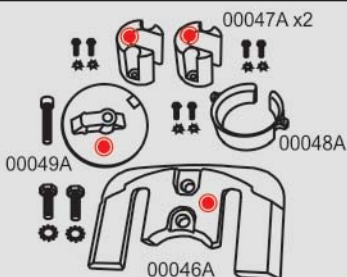

Bravo 1

Weight: 2.0 lbs (0.9 Kg)  
Replaces Mercury # 888758Q02  
Pack Size: 5 1/2 x 11 x 2 3/4  
(140 x 279 x 70)



10061A

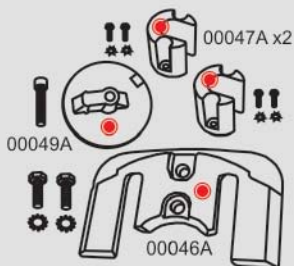

Bravo 2/3

Weight: 1.9 lbs (0.85 Kg)  
Replaces Mercury # 888761Q03  
Pack Size: 5 1/2 x 11 x 2 3/4  
(140 x 279 x 70)



10165A

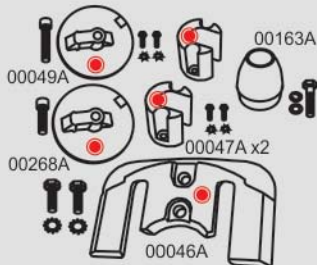





Bravo 3 (2004+)



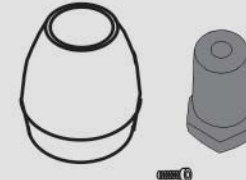





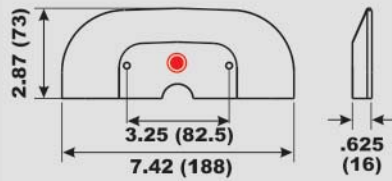

Weight: 2.7 lbs (1.2 Kg)  
Replaces Mercury # 888761Q04  
Pack Size: 5 1/2 x 11 x 2 3/4  
(140 x 279 x 70)

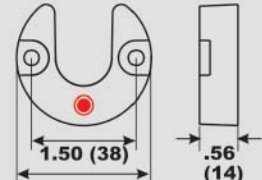

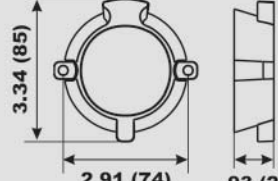

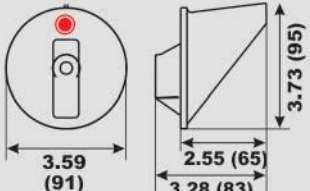

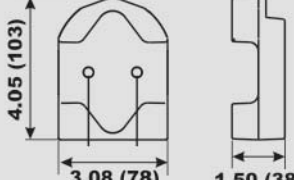





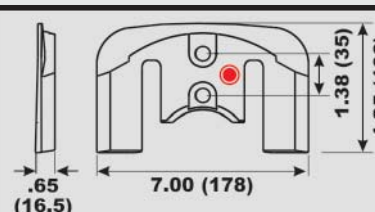



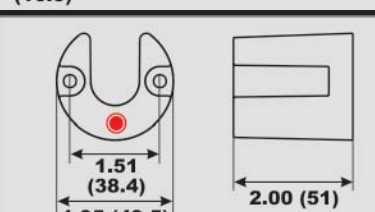

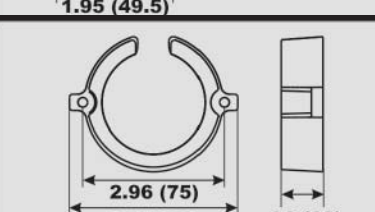



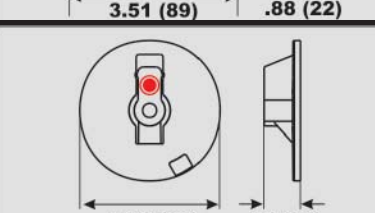

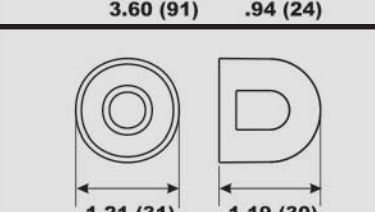
## MERCUISESTERNDRIVE KITS

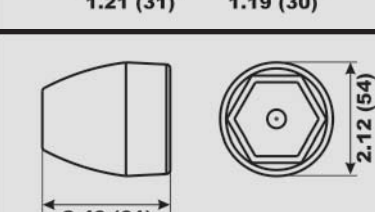
<p>10195A</p> 	<p>00196A</p> 	<p>Bravo 3 Prop Retrofit</p> <p>Weight: 1.25 lbs (0.6 Kg) Pack Size: 4 3/4 x 8 x 2 1/2 (121 x 203 x 64)</p> 
<p>10205A</p> 	<p>00045A</p>  <p>00044A      00050A</p>	<p>Alpha 1 Gen 1 Kit (No Power Steering)</p> <p>Weight: 1.6 lbs (0.7 Kg) Replaces Mercury # 888756Q04 Pack Size: 5 1/2 x 11 x 2 3/4 (140 x 279 x 70)</p> 

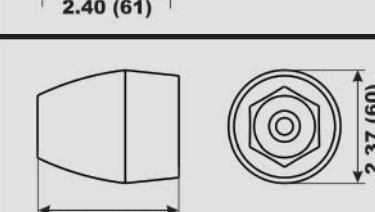
## MERCUISESTERNDRIVE ANODES

<p>00041A</p> 		<p><b>Alpha Cavitation Plate</b></p>  <p>Weight: 0.55 lbs (0.24 Kg) Replaces Mercury # 821629T 1</p>
<p>00042A</p> 		<p><b>Alpha Trim Cylinder Anode</b></p>  <p>Weight: 0.07 lbs (0.03 Kg) Replaces Mercury # 806189T 1</p>
<p>00043A</p> 		<p><b>Alpha Bearing Carrier</b></p>  <p>Weight: 0.17 lbs (0.08 Kg) Replaces Mercury # 806105T 1</p>
<p>00044A</p> 		<p><b>Trim Tab Anode</b></p>  <p>Weight: 0.4 lbs (0.17 Kg) Replaces Mercury # 31640T 4</p>
<p>00045A</p> 		<p><b>Gimbal Housing Block</b></p>  <p>Weight: 0.7 lbs (0.3 Kg) Replaces Mercury # 821631T 1</p>

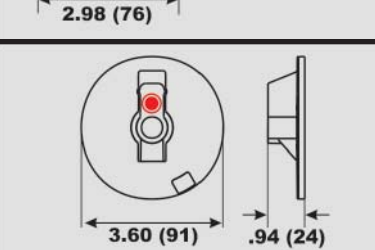





# MERCUISER STERNDRIIVE KITS

<p>00046A</p> 	 <p>.65 (16.5)      7.00 (178)      1.38 (35)      4.25 (108)</p>	<p><b>Bravo Cavitation Plate</b> </p> <p>Weight: 0.8 lbs (0.35 Kg)</p> <p>Replaces Mercury # 821630T 1</p>
<p>00047A </p> 	 <p>1.51 (38.4)      2.00 (51)      1.95 (49.5)</p>	<p><b>Bravo Trim Cylinder Anode</b> </p> <p>Weight: 0.27 lbs (0.12 Kg)</p> <p>Replaces Mercury # 806190T 1</p>
<p>00048A</p> 	 <p>2.96 (75)      .88 (22)      3.51 (89)</p>	<p><b>Bravo Bearing Carrier</b> </p> <p>Weight: 0.16 lbs (0.07 Kg)</p> <p>Replaces Mercury # 806188A 1</p>
<p>00049A </p> 	 <p>3.60 (91)      .94 (24)</p>	<p><b>Trim Tab Anode Flat</b> </p> <p>Weight: 0.25 lbs (0.1 Kg)</p> <p>Replaces Mercury # 76214T 5</p>
<p>00050A</p> 	 <p>1.21 (31)      1.19 (30)</p>	<p><b>Gimbal Housing Bolt Headnut (Qty 2)</b> </p> <p>Weight: 0.15 lbs (0.07 Kg)</p> <p>Replaces Mercury # 55989T 9</p>
<p>00163A</p> 	 <p>2.40 (61)      2.12 (54)</p>	<p><b>Prop Anode Bravo 3 (2004)</b> </p> <p>Weight: 0.4 lbs (0.18 Kg)</p> <p>Replaces Mercury # 865182A 1</p>
<p>00196A</p> 	 <p>2.98 (76)      2.37 (60)</p>	<p><b>Prop Anode Bravo 3 (2003 and Older)</b> </p> <p>Weight: 0.6 lbs (0.28 Kg)</p>
<p>00268A </p> 	 <p>3.60 (91)      .94 (24)</p>	<p><b>Trim Anode Flat (No Thread)</b> </p> <p>Weight: 0.6 lbs (0.28 Kg)</p> <p>Replaces Mercury # 76214 4</p>

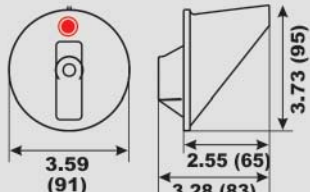

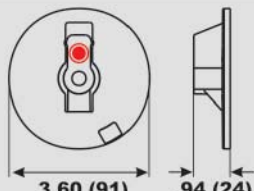

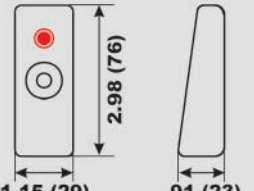





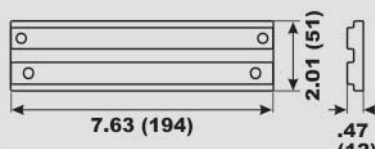

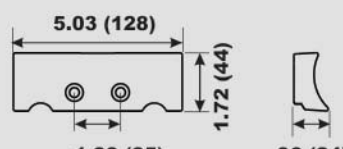

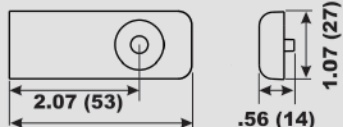

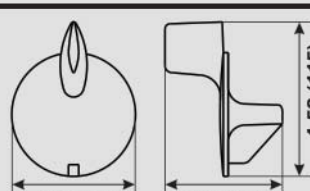

## MERCURY OUTBOARD KITS

<p>10202A</p> 	<p>00049A      00051A X2</p>  <p>00052A</p>	<p>Verado 4 &amp; Optimax Kit</p> <p>Weight: 1.6 lbs (0.7 Kg) Pack Size: 5 ½ x 11 x 2 ¾ (140 x 279 x 70)</p> 
<p>10203A</p> 	<p>00049A      00051A X2</p>  <p>00093A 00094A X4</p>	<p>Verado 6 Kit</p> <p>Weight: 1.6 lbs (0.7 Kg) Pack Size: 5 ½ x 11 x 2 ¾ (140 x 279 x 70)</p> 
<p>10212A</p> 	<p>00044A      00051A X2</p>  <p>00052A</p>	<p>75-115 EFI Kit</p> <p>Weight: 1.5 lbs (0.7 Kg) Pack Size: 5 ½ x 11 x 2 ¾ (140 x 279 x 70)</p> 

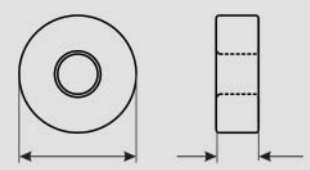
## MERCURY OUTBOARD ANODES

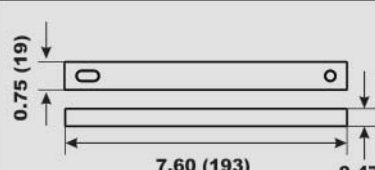
<p>00044A ●</p> 	 <p>3.59 (91)      2.55 (65)      3.73 (95) 3.28 (83)</p>	<p><b>Trim Tab Anode</b></p>  <p>Weight: 0.4 lbs (0.17 Kg) Replaces Mercury # 31640T 4</p>
<p>00049A ●</p> 	 <p>3.60 (91)      .94 (24)</p>	<p><b>Trim Tab Anode Flat</b></p>  <p>Weight: 0.25 lbs (0.1 Kg) Replaces Mercury # 76214T 5</p>
<p>00051A ●</p> 	 <p>2.98 (76)      .91 (23) 1.15 (29)</p>	<p><b>Side Pocket Anode</b></p>  <p>Weight: 0.18 lbs (0.08 Kg) Replaces Mercury # 826134T</p>

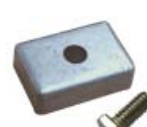
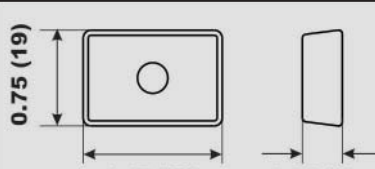
## MERCURY OUTBOARD ANODES

<p>00052A</p> 		<p><b>Outboard Power Trim Anode</b> </p> <p>Weight: 0.5 lbs (0.23 Kg)</p> <p>Replaces Mercury # 818298T 1</p>
<p>00093A</p> 		<p><b>Manifold Anode</b> </p> <p>Weight: 0.5 lbs (0.23 Kg)</p> <p>Replaces Mercury # 880653</p>
<p>00094A</p> 		<p><b>Trim Cylinder Verado</b> </p> <p>Weight: 0.1 lbs (0.04 Kg)</p> <p>Replaces Mercury # 893404</p>
<p>00222A</p> 		<p><b>Gear Housing Anode 6-15hp</b> </p> <p>Weight: 0.03 lbs (0.01 Kg)</p> <p>Replaces Mercury # 42121Q02</p>
<p>00223A</p> 		<p><b>Trim Tab 9.9-25hp</b> </p> <p>Weight: 0.4 lbs (0.18 Kg)</p> <p>Replaces Mercury # 98432Q6</p>
<p>00224A</p> 		<p><b>Round Anode 4-30hp</b> </p> <p>Weight: 0.04 lbs (0.02 Kg)</p> <p>Replaces Mercury # 823912</p>
<p>00225A</p> 		<p><b>Bar Anode 25-40hp</b> </p> <p>Weight: 0.24 lbs (0.11 Kg)</p> <p>Replaces Mercury # 825271 1</p>
<p>00226A</p> 		<p><b>Square Block 4-9.9hp</b> </p> <p>Weight: 0.06 lbs (0.03 Kg)</p> <p>Replaces Mercury # 875208</p>

## MERCURY OUTBOARD ANODES

00380A

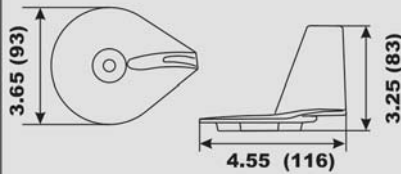

**Trim Tab Anode 25-50 hp**



Weight: 0.6 lbs (0.28 Kg)

Replaces Mercury # 822157T 2

## SUZUKI ANODE KITS

10480A

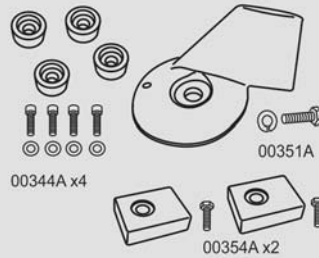

Suzuki 40-50 hp Kit

Weight: 0.8 lbs (0.36 Kg)

Pack Size: 5 1/2 x 11 x 2 3/4  
(140 x 279 x 70)



10481A

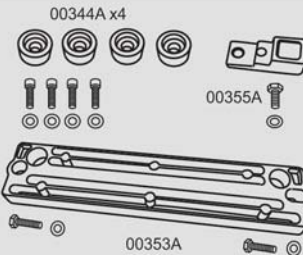

Suzuki 90-140 hp Kit

Weight: 0.9 lbs (0.4 Kg)

Pack Size: 5 1/2 x 11 x 2 3/4  
(140 x 279 x 70)



10482A

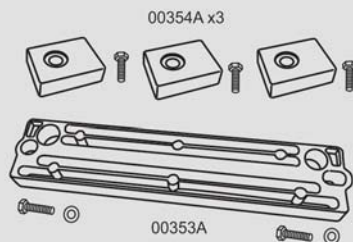

Suzuki 200-250 hp Kit

Weight: 1.0 lbs (0.45 Kg)

Pack Size: 5 1/2 x 11 x 2 3/4  
(140 x 279 x 70)



## SUZUKI ANODES

00344A

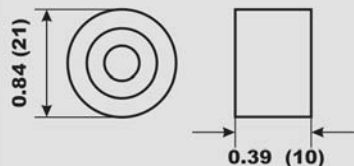

**Round Anode**



Weight: 0.02 lbs (0.01 Kg)

Anode for Suzuki # 55321-87J00

00351A

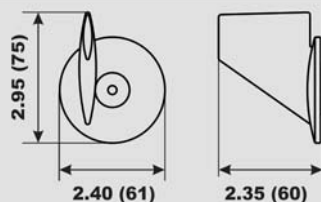

**Trim Tab - 40-85hp**



Weight: 0.16 lbs (0.07 Kg)

Anode for Suzuki # 55125-95500

# SUZUKI ANODES

00352A

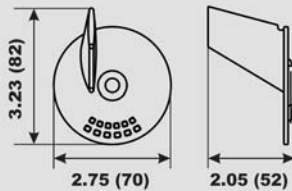

**Trim Tab - 25-30hp**



Weight: 0.1 lbs (0.05 Kg)

Anode for Suzuki # 55125-96310

00353A



**Outboard Bar Anode - 40-300hp**



Weight: 0.4 lbs (0.18 Kg)

Anode for Suzuki # 55320-94900

00354A

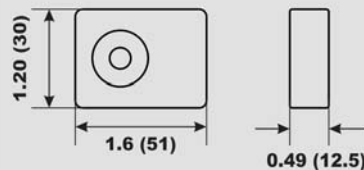

**Small Block Anode - 4-300hp**



Weight: 0.07 lbs (0.03 Kg)

Anode for Suzuki # 55320-95311

00355A

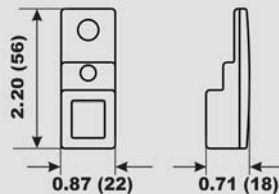

**Gear Case Anode - 60-140hp**



Weight: 0.07 lbs (0.03 Kg)

Anode for Suzuki # 55321-90J01

00356A

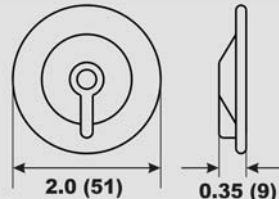

**Outboard Anode - 9.9-15hp**



Weight: 0.05 lbs (0.02 Kg)

Replaces Suzuki # 55321-939900

# VETUS ANODE

00671A

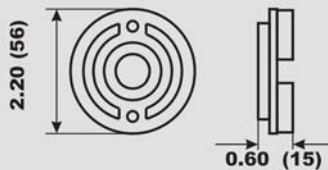

**Vetus Bow Thruster 75/80/95**



Weight: 0.15 lbs (0.07 Kg)

Replaces SET0150



# VOLVO PENTA ANODE KITS

10274A

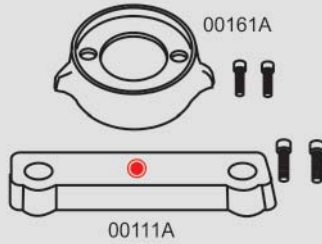

Volvo 280

Weight: 1.6 lbs (0.7 Kg)  
Pack Size: 5 ½ x 11 x 2 ¾  
(140 x 279 x 70)



10275A

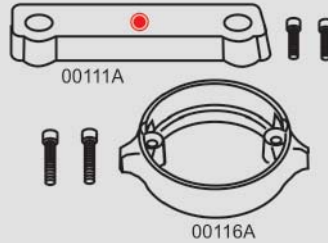

Volvo 280 Dual Prop

Weight: 1.3 lbs (0.6 Kg)  
Pack Size: 5 ½ x 11 x 2 ¾  
(140 x 279 x 70)



10276A

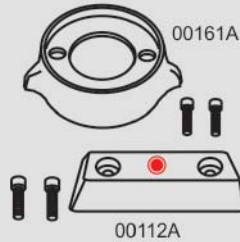

Volvo 290

Weight: 1.6 lbs (0.7 Kg)  
Pack Size: 5 ½ x 11 x 2 ¾  
(140 x 279 x 70)



10277A

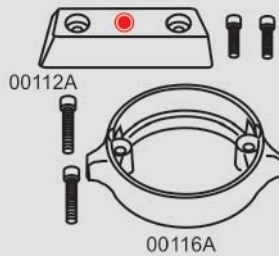

Volvo 290 Dual Prop

Weight: 1.3 lbs (0.6 Kg)  
Pack Size: 5 ½ x 11 x 2 ¾  
(140 x 279 x 70)



10278A



Volvo SX

Weight: 2.1 lbs (1.0 Kg)  
Pack Size: 5 ½ x 11 x 2 ¾  
(140 x 279 x 70)



10289A

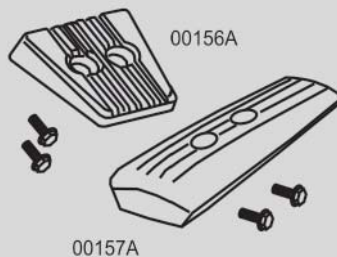

Volvo DP-S/SX-A

Weight: 1.6 lbs (0.7 Kg)  
Pack Size: 5 ½ x 11 x 2 ¾  
(140 x 279 x 70)





# VOLVO PENTA ANODE KITS

10303A

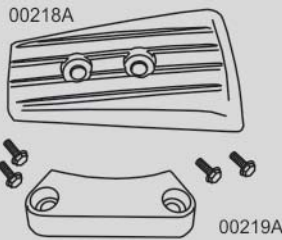

Volvo DPH/DPR

Weight: 1.6 lbs (0.7 Kg)  
Pack Size: 5 ½ x 11 x 2 ¾  
(140 x 279 x 70)



10276AE

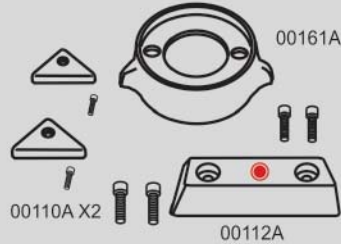

Volvo 290 Export

Weight: 1.8 lbs (0.8 Kg)  
Pack Size: 5 ½ x 11 x 2 ¾  
(140 x 279 x 70)



10277AE

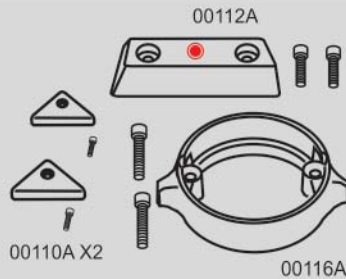

Volvo 290 Dual Prop Export

Weight: 1.5 lbs (0.7 Kg)  
Pack Size: 5 ½ x 11 x 2 ¾  
(140 x 279 x 70)



# VOLVO PENTA ANODES

00110A

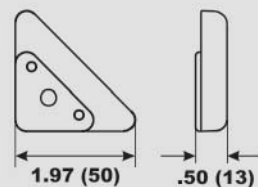

**Side Mounted Anode**  
**- SX, DP-X**

Weight: 0.1 lbs (0.04 Kg)

Replaces Volvo # 872793



00111A ●

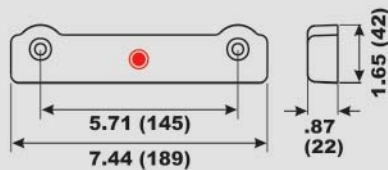

**Anodic Bar**

Weight: 0.8 lbs (0.36 Kg)

Replaces Volvo # 832598



00112A ●

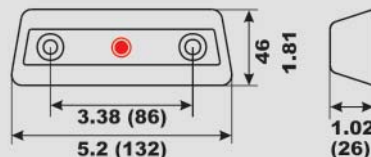











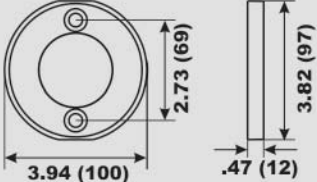

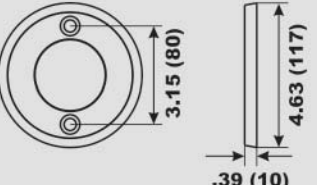

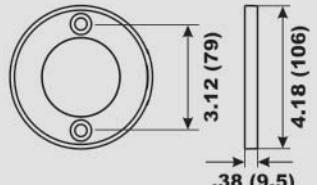

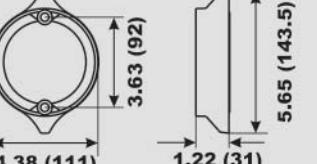

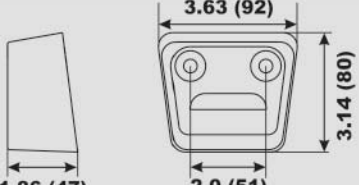
**Anodic Bar**

Weight: 0.7 lbs (0.3 Kg)

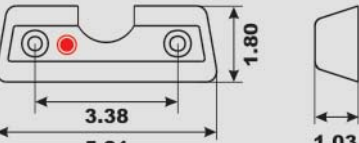

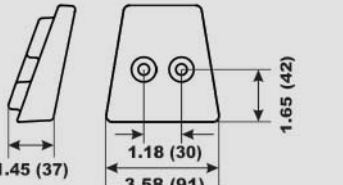

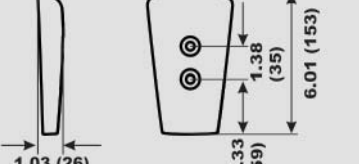





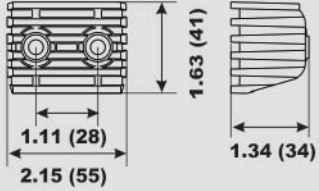

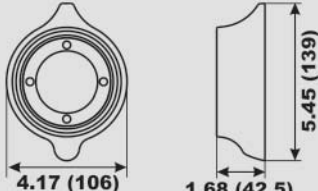

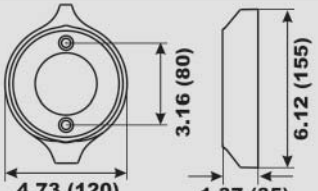

Replaces Volvo # 852835

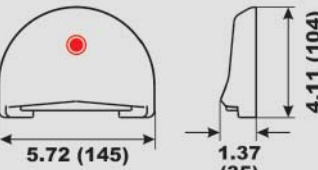

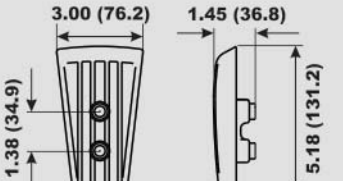

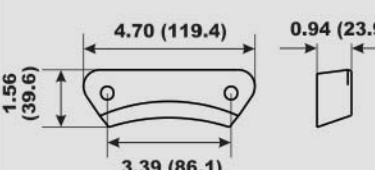

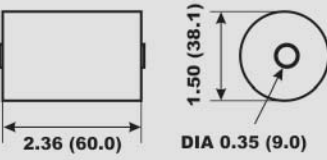





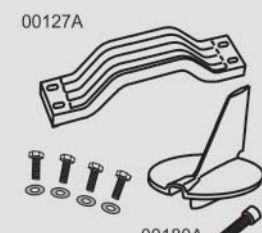

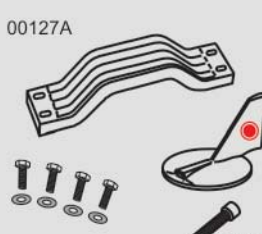
# VOLVO PENTA ANODES

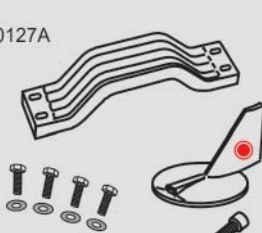
<p>00113A</p> 		<p><b>Prop Ring - V15</b></p> <p>Weight: 0.15 lbs (0.07 Kg)</p> <p>Replaces Volvo # 875810</p> 
<p>00114A</p> 		<p><b>Prop Ring - V17</b></p> <p>Weight: 0.25 lbs (0.1 Kg)</p> <p>Replaces Volvo # 875805</p> 
<p>00115A</p> 		<p><b>Prop Ring - V16</b></p> <p>Weight: 0.2 lbs (0.07 Kg)</p> <p>Replaces Volvo # 875809</p> 
<p>00116A</p> 		<p><b>Prop Ring - Duo Prop</b></p> <p>Weight: 0.5 lbs (0.23 Kg)</p> <p>Replaces Volvo # 875821</p> 
<p>00117A</p> 		<p><b>Gimbal Plate - SX</b></p> <p>Weight: 0.9 lbs (0.4 Kg)</p> <p>Replaces Volvo # 3854130</p> 
<p>00118A </p> 		<p><b>Anodic Bar</b></p> <p>Weight: 0.6 lbs (0.25 Kg)</p> <p>Replaces Volvo # 872139</p> 
<p>00156A</p> 		<p><b>Transom DPS-A/SX-A</b></p> <p>Weight: 1.1 lbs (0.5 Kg)</p> <p>Replaces Volvo #s 3841427/3888816</p> 
<p>00157A</p> 		<p><b>Gearhouse DPS-A/SX-A</b></p> <p>Weight: 1.5 lbs (0.7 Kg)</p> <p>Replaces Volvo #s 3883728/3888813</p> 

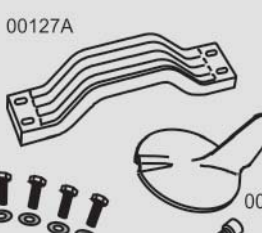
# VOLVO PENTA ANODES

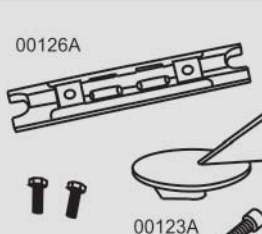
<p>00158A</p> 	 <p>1.63 (41) 1.11 (28) 2.15 (55) 1.34 (34)</p>	<p><b>DPX Outdrive Cube</b> </p> <p>Weight: 0.3 lbs (0.15 Kg)</p> <p>Replaces Volvo # 873395</p>
<p>00160A</p> 	 <p>4.17 (106) 1.68 (42.5) 5.45 (139)</p>	<p><b>Prop Ring - 110 Sail Drive</b> </p> <p>Weight: 0.8 lbs (0.35 Kg)</p> <p>Replaces Volvo # 875812</p>
<p>00161A</p> 	 <p>3.16 (80) 4.73 (120) 1.37 (35) 6.12 (155)</p>	<p><b>Prop Ring - V18</b> </p> <p>Weight: 0.6 lbs (0.26 Kg)</p> <p>Replaces Volvo # 875815</p>
<p>00162A </p> 	 <p>5.72 (145) 1.37 (35) 4.11 (104)</p>	<p><b>Transom Plate - SX</b> </p> <p>Weight: 0.9 lbs (0.4 Kg)</p> <p>Replaces Volvo # 3855411</p>
<p>00218A</p> 	 <p>3.00 (76.2) 1.45 (36.8) 1.38 (34.9) 5.18 (131.2)</p>	<p><b>Cavitation Plate - DPH/DPR</b> </p> <p>Weight: 0.8 lbs (0.35 Kg)</p> <p>Replaces Volvo # 3588748</p>
<p>00219A</p> 	 <p>4.70 (119.4) 0.94 (23.9) 1.56 (39.6) 3.39 (86.1)</p>	<p><b>Transon Shield - DPH/DPR</b> </p> <p>Weight: 0.5 lbs (0.23 Kg)</p> <p>Replaces Volvo # 3588745</p>
<p>00349A</p> 	 <p>2.36 (60.0) 1.50 (38.1) DIA 0.35 (9.0)</p>	<p><b>Volvo D4/D6 Exhaust Anode</b> </p> <p>Weight: 0.4 lbs (0.18 Kg)</p> <p>Anode for Volvo #218680/1/2</p>

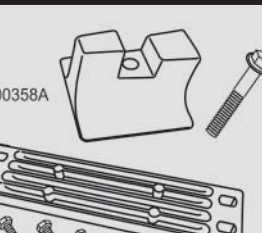
# YAMAHA ANODE KITS

<p>10182A</p> 	<p>00127A</p>  <p>00180A</p>	<p>Yamaha Kit 200 hp-250hp 4 Stroke</p> <p>Weight: 2.3 lbs (1.05 Kg) Pack Size: 5 1/2 x 11 x 2 3/4 (140 x 279 x 70)</p> 
<p>10183A</p> 	<p>00127A</p>  <p>00125A</p>	<p>Yamaha Kit 150 hp</p> <p>Weight: 2.2 lbs (1.0 Kg) Pack Size: 5 1/2 x 11 x 2 3/4 (140 x 279 x 70)</p> 
<p>10184A</p> 	<p>00127A</p>  <p>00181A</p>	<p>Yamaha Kit 150 hp Counter Rotation</p> <p>Weight: 2.2 lbs (1.0 Kg) Pack Size: 5 1/2 x 11 x 2 3/4 (140 x 279 x 70)</p> 
<p>10186A</p> 	<p>00127A</p>  <p>00185A</p>	<p>Yamaha Kit 200-300 hp 2 Stroke</p> <p>Weight: 2.2 lbs (1.0 Kg) Pack Size: 5 1/2 x 11 x 2 3/4 (140 x 279 x 70)</p> 
<p>10187A</p> 	<p>00126A</p>  <p>00123A</p>	<p>Yamaha Kit 60-90 hp</p> <p>Weight: 1.1 lbs (0.5 Kg) Pack Size: 5 1/2 x 11 x 2 3/4 (140 x 279 x 70)</p> 
<p>10491A</p> 	<p>00358A</p>  <p>00357A</p>	<p>Yamaha Kit 300-350 hp XP</p> <p>Weight: 1.9 lbs (0.9 Kg) Pack Size: 5 1/2 x 11 x 2 3/4 (140 x 279 x 70)</p> 

## YAMAHA ANODE KITS

10493A



00364A

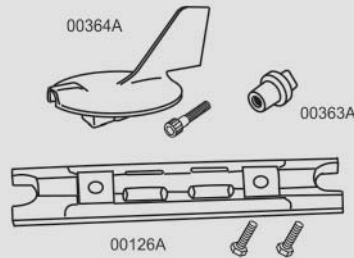

Yamaha Kit 80-100 hp

Weight: 1.5 lbs (0.7 Kg)  
Pack Size: 5 ½ x 11 x 2 ¾  
(140 x 279 x 70)



## YAMAHA ANODES

00119A ●

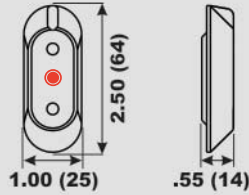

**Side Mounted**



Weight: 0.1 lbs (0.05 Kg)

Replaces Yamaha # 6E0-45251-11

00120A

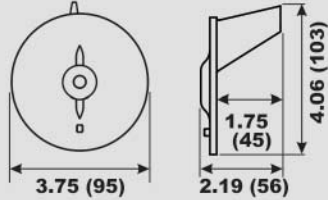

**Trim Tab**



Weight: 0.3 lbs (0.12 Kg)

Replaces Yamaha # 664-45371-01

00121A

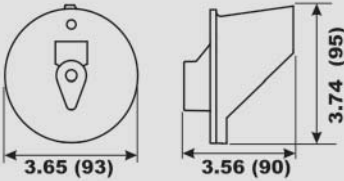

**Trim Tab Counter Rotating**



Weight: 0.4 lbs (0.2 Kg)

Replaces Yamaha # 6K1-45371-00

00122A

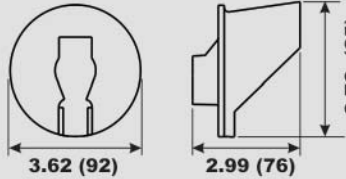

**Trim Tab**



Weight: 0.4 lbs (0.2 Kg)

Replaces Yamaha # 6E5-45371-01

00123A ●

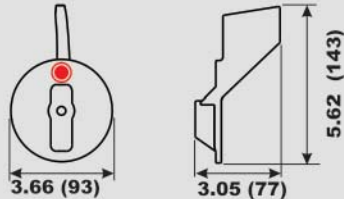

**Trim Tab 60 - 90 hp**



Weight: 0.4 lbs (0.2 Kg)

Replaces Yamaha # 688-45371-02

00124A

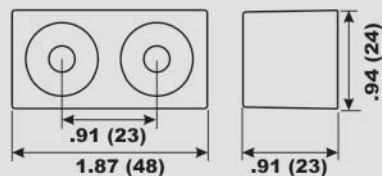













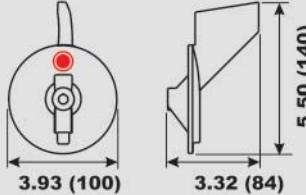

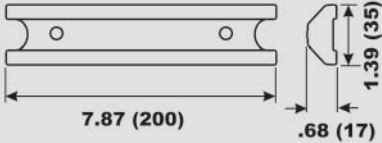

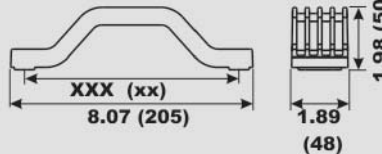

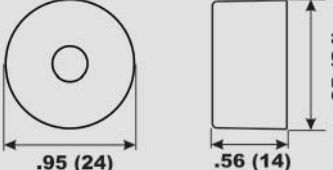

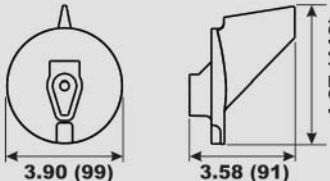
**Block**



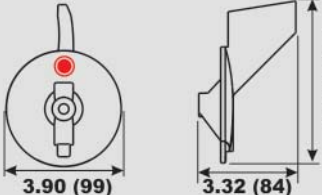

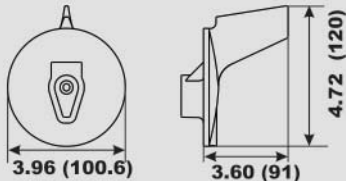

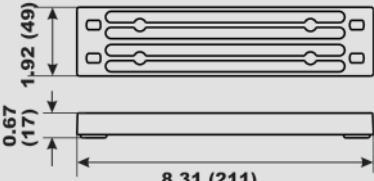





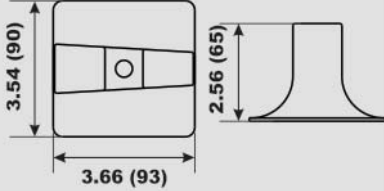



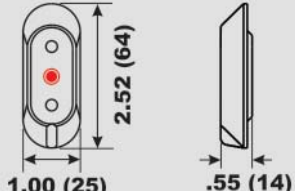

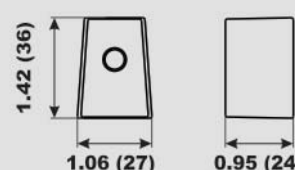

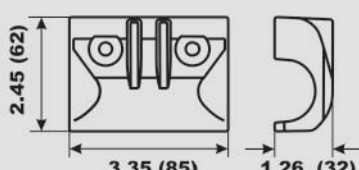
Weight: 0.15 lbs (0.07 Kg)

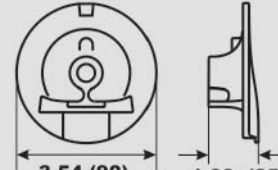
Replaces Yamaha # 6E5-45251-00

# YAMAHA ANODES

<p>00125A </p> 		<p><b>Trim Tab 150, 175 HP</b> </p> <p>Weight: 0.6 lbs (0.3 Kg)</p> <p>Replaces Yamaha # 6J9-45371-01</p>
<p>00126A</p> 		<p><b>Transom Anode</b> </p> <p>Weight: 0.45 lbs (0.2 Kg)</p> <p>Replaces Yamaha # 6H1-45251-02</p>
<p>00127A</p> 		<p><b>Transom Anode</b> </p> <p>Weight: 0.8 lbs (0.4 Kg)</p> <p>Replaces Yamaha # 6G5-45251-02</p>
<p>00128A</p> 		<p><b>Block</b> </p> <p>Weight: 0.04 lbs (0.02 Kg)</p> <p>Replaces Yamaha # 688-45251-01</p>
<p>00180A</p> 		<p><b>Trim Tab 200-250 HP 4-Stroke</b> </p> <p>Weight: 0.6 lbs (0.3 Kg)</p> <p>Replaces Yamaha # 61A-45371-00</p>
<p>00181A </p> 		<p><b>Trim Tab 150, 175 HP Counter Rotating</b> </p> <p>Weight: 0.6 lbs (0.3 Kg)</p> <p>Replaces Yamaha # 6K1-45371-02</p>
<p>00185A</p> 		<p><b>Trim Tab 200 - 300hp 2 stroke</b> </p> <p>Weight: 0.8 lbs (0.4 Kg)</p> <p>Replaces Yamaha # 69L-45371-00</p>
<p>00357A</p> 		<p><b>Outboard Bracket Anode</b> </p> <p>Weight: 0.58 lbs (0.26 Kg)</p> <p>Replaces Yamaha # 6AW-45251-00</p>

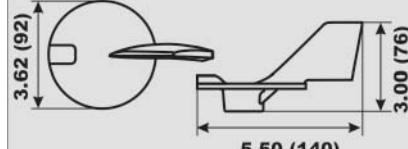
# YAMAHA ANODES

<p>00358A</p> 		<p><b>Lower Unit Anode</b> </p> <p>Weight: 0.9 lbs (0.4 Kg)</p> <p>Replaces Yamaha # 6AW-45373-00</p>
<p>00359A </p> 		<p><b>Clamp Bracket Anode 8-250hp</b> </p> <p>Weight: 0.12 lbs (0.05 Kg)</p> <p>Replaces Yamaha # 65W-45251-00</p>
<p>00360A</p> 		<p><b>Outboard Cube Anode 25-60hp</b> </p> <p>Weight: 0.07 lbs (0.03 Kg)</p> <p>Replaces Yamaha # 67C-45251-00</p>
<p>00361A</p> 		<p><b>Bracket Anode</b> </p> <p>Weight: 0.5 lbs (0.23 Kg)</p> <p>Replaces Yamaha # 63D-45251-01</p>
<p>00362A</p> 		<p><b>Outboard Cover Anode</b> </p> <p>Weight: 0.25 lbs (0.1 Kg)</p> <p>Replaces Yamaha # 6AW-45619-00</p>
<p>00363A</p> 		<p><b>Outboard Internal Anode</b> </p> <p>Weight: 0.1 lbs (0.05 Kg)</p> <p>Replaces Yamaha # 67F-11325-01</p>
<p>00364A</p> 		<p><b>Trim Tab 50-100hp</b> </p> <p>Weight: 0.45 lbs (0.2 Kg)</p> <p>Replaces Yamaha # 67F-45371-00</p>

## YANMAR ANODE

00035A

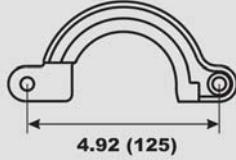

**Saildrive Split Ring Anode**



Weight: 0.75 lbs (0.35 Kg)

Replaces Yanmar 196440-02660

## MISCELLANEOUS ANODES

00350A

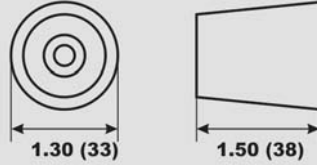

**Beneteau 23/25 Prop Anode**



Weight: 0.4 lbs (0.2 Kg)

F1549A

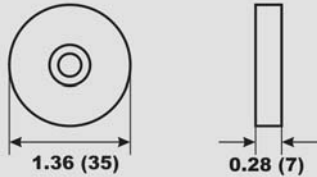

**Frigoboat Keel Cooler Anode**













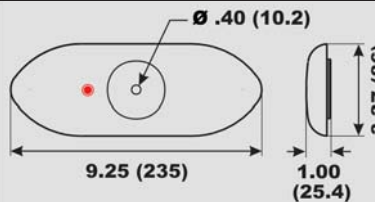



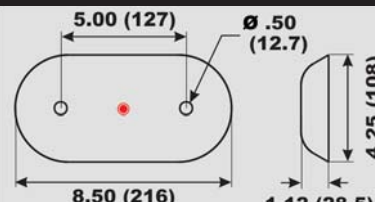

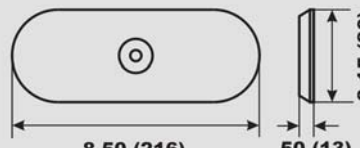



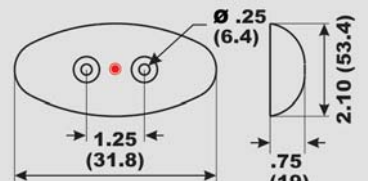



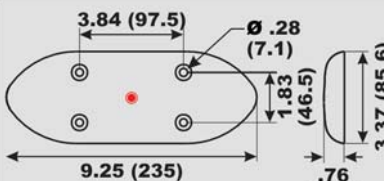



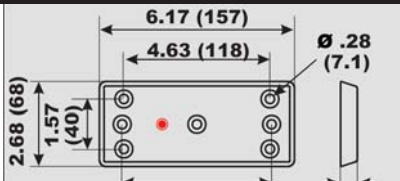

Weight: 0.04 lbs (0.02 Kg)

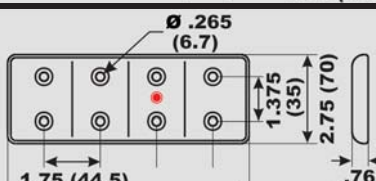



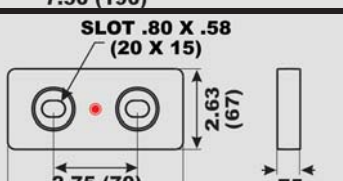









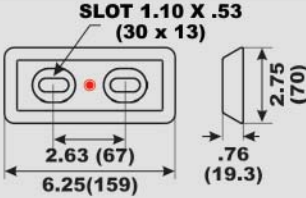



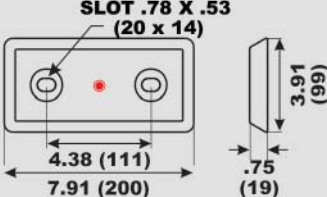



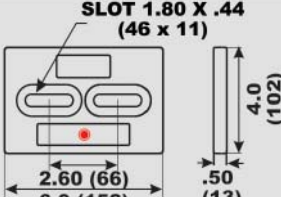



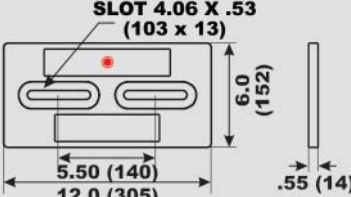



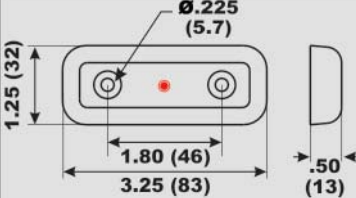

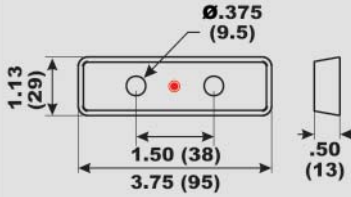

# HULL ANODES

<p>H404A </p> 	 <p>Ø .40 (10.2) 9.25 (235) 3.37 (86) 1.00 (25.4)</p>	<p><b>Hull Plate (Pacemaker)</b> Weight: 1.5 lbs (0.7 Kg)</p>	 <p>8 7064810012911</p>
<p>H406A </p> 	 <p>5.00 (127) Ø .50 (12.7) 8.50 (216) 4.25 (108) 1.12 (28.5)</p>	<p><b>Hull Plate</b> Weight: 2.6 lbs (1.2 Kg)</p>	 <p>8 7064810013017</p>
<p>HN1A</p> 	 <p>8.50 (216) 3.15 (80) .50 (13)</p>	<p><b>Hull Plate</b> Weight: 1.2 lbs (0.6 Kg)</p>	 <p>8 7064810003913</p>
<p>HM24A </p> 	 <p>Ø .25 (6.4) 1.25 (31.8) 4.40 (112) 2.10 (53.4) .75 (19)</p>	<p><b>Hull Plate</b> Weight: 0.3 lbs (0.14 Kg)</p>	 <p>8 7064810013114</p>
<p>HM25A </p> 	 <p>3.84 (97.5) Ø .28 (7.1) 9.25 (235) 1.83 (46.5) 3.37 (85.6) .76 (19.3)</p>	<p><b>Hull Plate</b> Weight: 1.5 lbs (0.7 Kg)</p>	 <p>8 7064810013211</p>
<p>HM30A </p> 	 <p>6.17 (157) 4.63 (118) Ø .28 (7.1) 2.68 (68) 1.57 (40) 4.73 (120) 0.53 (13.5)</p>	<p><b>Hull Plate</b> Weight: 0.8 lbs (0.4 Kg)</p>	 <p>8 7064810013318</p>
<p>HM40A </p> 	 <p>Ø .265 (6.7) 1.375 (35) 2.75 (70) 1.75 (44.5) 7.50 (190) .76 (19.3)</p>	<p><b>Hull Plate</b> Weight: 0.8 lbs (0.4 Kg)</p>	 <p>8 7064810013415</p>
<p>HC2A </p> 	 <p>SLOT .80 X .58 (20 X 15) 2.63 (67) 2.75 (70) 5.75 (146) .75 (19)</p>	<p><b>Hull Plate</b> Weight: 1.0 lbs (0.5 Kg)</p>	 <p>8 7064810013512</p>

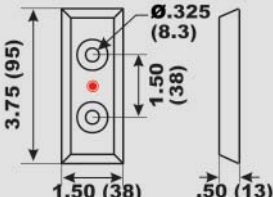
WEAR INDICATOR INSTALLED

Dimensions - inches (mm)

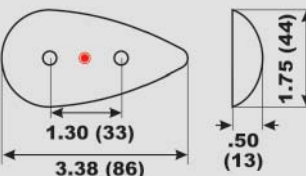
# HULL ANODES

<p>HC3A</p> 		<p><b>Hull Plate</b></p>  <p>Weight: 0.9 lbs (0.4 Kg)</p>
<p>HC5A </p> 		<p><b>Hull Plate</b></p>  <p>Weight: 1.9 lbs (0.9 Kg)</p>
<p>HMDDA </p> 		<p><b>Hull Plate - Mini Diver's Anode</b></p>  <p>Weight: 1.1 lbs (0.5 Kg)</p>
<p>HDDRA </p> 		<p><b>Hull Plate - Diver's Anode</b></p>  <p>Weight: 3.5 lbs (1.6 Kg)</p>
<p>HDOKA </p> 		<p><b>Doka Strainer Anode</b></p>  <p>Weight: 0.2 lbs (0.1 Kg)</p>
<p>HBNTA </p> 		<p><b>Bennett Trim Tab Anode (2 per)</b></p>  <p>Weight: 0.4 lbs (0.2 Kg)</p>
<p>HBSLA </p> 		<p><b>Bosler Strainer Anode</b></p>  <p>Weight: 0.2 lbs (0.1 Kg)</p>
<p>T20A </p> 		<p><b>Small Teardrop Anode</b></p>  <p>Weight: 0.2 lbs (0.1 Kg)</p>

## HULL ANODES

T21A 

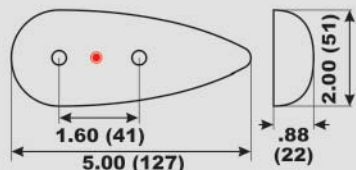

**Large Teardrop Anode**

Weight: 0.3 lbs (0.15 Kg)



HYAA 

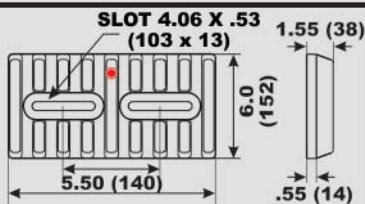

**Boater's Dream Yacht Anode**

Weight: 5.7 lbs (2.6 Kg)



## EUROPEAN HULL ANODES

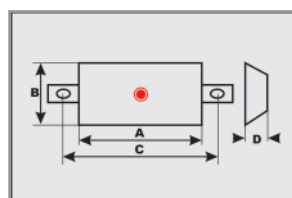

Part #	A	B	C	D	Weight	UPC
HE002A	100mm (3.9")	34mm (1.3")	116mm (4.6")	17mm (0.7")	0.23 lbs (0.1Kg)	
HE005A	118mm (4.6")	45mm (1.8")	140mm (5.5")	24mm (1")	0.5 lbs (0.21Kg)	
HE010A	144mm (5.7")	60mm (2.4")	185mm (7.3")	28mm (1.1")	0.9 lbs (0.42Kg)	
HE020A	165mm (6.5")	88mm (3.5")	185mm (7.3")	30mm (1.2")	1.8 lbs (0.83Kg)	
HE035A	210mm (8.3")	95mm (3.7")	260mm (10.2")	30mm (1.2")	3.2 lbs (1.5Kg)	
HE055A	265mm (10.4")	115mm (4.5")	310mm (12.2")	35mm (1.2")	5 lbs (2.2Kg)	

HE0XXA-A - w/ Aluminum Strap

## HANGING ANODES



## COMMERCIAL ANODES

HD56A

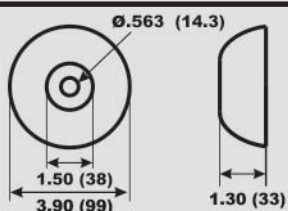













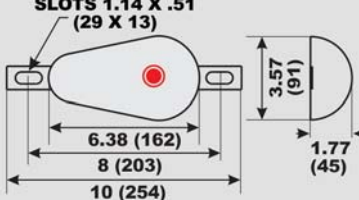



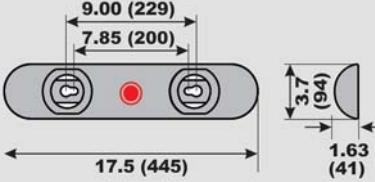



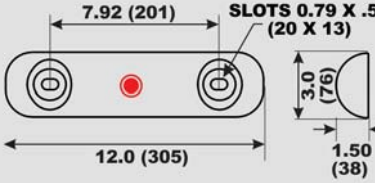

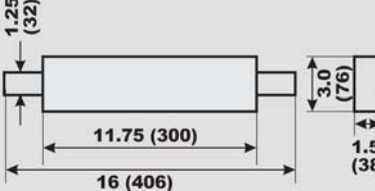
**0.4 Kg Disc Anode**

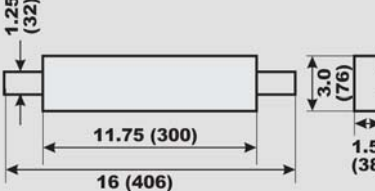
Weight: 1.0 lbs (0.45 Kg)

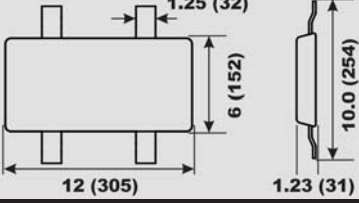
Replaces ZD56, AD56

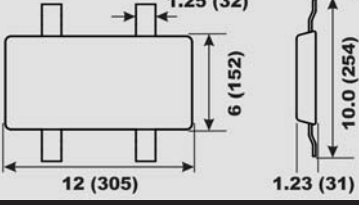

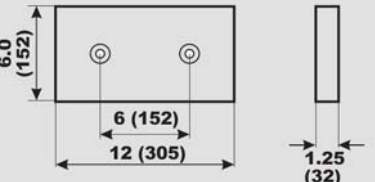
# COMMERCIAL ANODES

<p>HD77A </p> 		<p><b>0.9 Kg Pear Strap Anode</b> </p> <p>Weight: 1.8 lbs (0.8 Kg)</p> <p>Replaces ZD77</p>
<p>HD72BMA </p> 		<p><b>2.5 Kg Hull Anode</b> </p> <p>Weight: 4.5 lbs (2.5 Kg)</p> <p>Replaces ZD72B</p>
<p>HD78BA </p> 		<p><b>1.5 Kg Hull Anode</b> </p> <p>Weight: 3.3 lbs (1.5 Kg)</p> <p>Replaces ZD78B</p>
<p>HA3A-S</p> 		<p><b>5 lb Strap Anode - Steel Strap</b> </p> <p>Weight: 4.5 lbs (2 Kg)</p> <p>Replaces GA12, ZSS-12</p>
<p>HA3A-A</p> 		<p><b>5 lb Strap Anode - Aluminum Strap</b> </p> <p>Weight: 4.5 lbs (2 Kg)</p> <p>Replaces GA12, ZSS-12</p>
<p>HS23A-S (AHS-10)</p> 		<p><b>10 lb Strap Anode - Steel Strap</b> </p> <p>Weight: 8.7 lbs (4 Kg)</p> <p>Replaces GA23, ZHS-23, AZHS-23</p>
<p>HS23A-A</p> 		<p><b>10 lb Strap Anode - Aluminum Strap</b> </p> <p>Weight: 8.7 lbs (4 Kg)</p> <p>Replaces GA23, ZHS-23, AZHS-23</p>
<p>HC23A (AHC-10)</p> 		<p><b>10 lb Hull Anode - w/ Bolt Holes</b> </p> <p>Weight: 8.7 lbs (4 Kg)</p> <p>Replaces GA23C, ZHC-23, AZHC-23</p>

# SHAFT ANODES - REDUCED CLEARANCE

## IMPERIAL SIZES



Part #	A	B	C	Weight	UPC
RC0750A (C1)	3/4" (19mm)	2 1/8" (54mm)	1" (25.4mm)	0.26 lbs (0.12Kg)	
RC0875A (C2)	7/8" (22mm)	2 1/8" (54mm)	1" (25.4mm)	0.26 lbs (0.12Kg)	
RC1000A (C3)	1" (25.4mm)	2 1/2" (64mm)	1 1/4" (32mm)	0.44 lbs (0.2Kg)	
RC1125A (C4)	1 1/8" (29mm)	2 1/2" (64mm)	1 1/4" (32mm)	0.39 lbs (0.18Kg)	
RC1250A (C5)	1 1/4" (32mm)	2 1/2" (64mm)	1 1/4" (32mm)	0.38 lbs (0.17Kg)	
RC1375A (C6)	1 3/8" (35mm)	3" (76mm)	1 1/4" (32mm)	0.58 lbs (0.26Kg)	
RC1500A (C7)	1 1/2" (38mm)	3" (76mm)	1 1/4" (32mm)	0.52 lbs (0.24Kg)	
RC1750A (C8)	1 3/4" (44mm)	3 1/2" (89mm)	1 3/8" (35mm)	0.82 lbs (0.37Kg)	
RC2000A (C9)	2" (51mm)	3 1/2" (89mm)	1 3/8" (35mm)	0.7 lbs (0.32Kg)	
RC2250A (C11)	2 1/4" (57mm)	3 1/2" (89mm)	1 3/8" (35mm)	0.64 lbs (0.3Kg)	

## METRIC SIZES

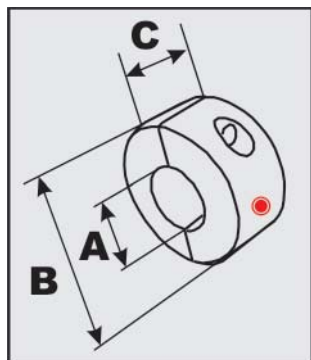



Part #	A	B	C	Weight	UPC
RCM20A	20mm (0.79")	2 1/8" (54mm)	1" (25.4mm)	0.26 lbs (0.12Kg)	
RCM25A	25mm (0.98")	2 1/2" (64mm)	1 1/4" (32mm)	0.44 lbs (0.2Kg)	
RCM30A	30mm (1.18")	2 1/2" (64mm)	1 1/4" (32mm)	0.37 lbs (0.17Kg)	
RCM35A	35mm (1.37")	3" (76mm)	1 1/4" (32mm)	0.58 lbs (0.26Kg)	
RCM40A	40mm (1.57")	3" (76mm)	1 1/4" (32mm)	0.52 lbs (0.24Kg)	
RCM45A	45mm (1.77")	3 1/2" (89mm)	1 3/8" (35mm)	0.81 lbs (0.37Kg)	
RCM50A	50mm (1.97")	3 1/2" (89mm)	1 3/8" (35mm)	0.7 lbs (0.32Kg)	
RCM60A	60mm (2.36")	3 1/2" (89mm)	1 3/8" (35mm)	0.64 lbs (0.3Kg)	

# SHAFT ANODES - STREAMLINED COLLAR

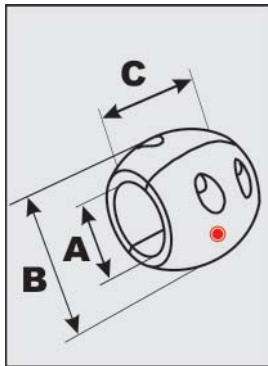
## IMPERIAL SIZES





Part #	A	B	C	Weight	UPC
C0500A	½" (13mm)	2 1/8" (54mm)	2 1/8" (54mm)	0.49 lbs (0.22Kg)	 8 70648 00017 1
C0625A	5/8" (16mm)	2 1/8" (54mm)	2 1/8" (54mm)	0.47 lbs (0.21Kg)	 8 70648 00018 8
C0750A (X1)	¾" (19mm)	2 1/8" (54mm)	2 1/8" (54mm)	0.45 lbs (0.2Kg)	 8 70648 00073 7
C0875A (X2)	7/8" (22mm)	2 1/8" (54mm)	2 1/8" (54mm)	0.43 lbs (0.2Kg)	 8 70648 00074 4
C1000A (X3)	1" (25.4mm)	2 1/8" (54mm)	2 1/8" (54mm)	0.4 lbs (0.18Kg)	 8 70648 00075 1
C1125A (X4)	1 1/8" (29mm)	2 1/8" (54mm)	2 1/8" (54mm)	0.36 lbs (0.16Kg)	 8 70648 00076 8
C1250A (X5)	1 1/4" (32mm)	2 1/4" (57mm)	2 ½" (64mm)	0.46 lbs (0.21Kg)	 8 70648 00077 5
C1250AA (Large)	1 1/4" (32mm)	2 ½" (64mm)	2 ½" (64mm)	0.66 lbs (0.3Kg)	 8 70648 00078 2
C1375A (X6)	1 3/8" (35mm)	2 ½" (64mm)	2 ½" (64mm)	0.6 lbs (0.27Kg)	 8 70648 00079 9
C1500A (X7)	1 ½" (38mm)	2 ½" (64mm)	2 ½" (64mm)	0.53 lbs (0.24Kg)	 8 70648 00080 5
C1750A (X8)	1 3/4" (44mm)	3 1/4" (83mm)	2 7/8" (73mm)	1.15 lbs (0.52Kg)	 8 70648 00081 2
C2000A (X9)	2" (51mm)	3 1/4" (83mm)	2 7/8" (73mm)	0.93 lbs (0.42Kg)	 8 70648 00082 9
C2250A (X10)	2 1/4" (57mm)	4 1/4" (108mm)	3 3/4" (95mm)	2.47 lbs (1.1Kg)	 8 70648 00083 6
C2500A (X11)	2 ½" (64mm)	4 1/4" (108mm)	3 3/4" (95mm)	2.23 lbs (1.0Kg)	 8 70648 00084 3
C2750A (X12)	2 3/4" (70mm)	4 3/4" (121mm)	3 5/8" (92mm)	2.75 lbs (1.2Kg)	 8 70648 00085 0
C3000A (X13)	3" (76mm)	4 3/4" (121mm)	3 5/8" (92mm)	2.4 lbs (1.1Kg)	 8 70648 00086 7

# SHAFT ANODES - REDUCED CLEARANCE

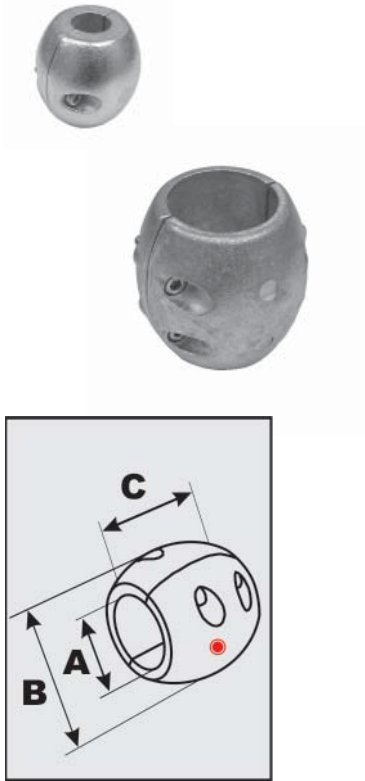
## METRIC SIZES









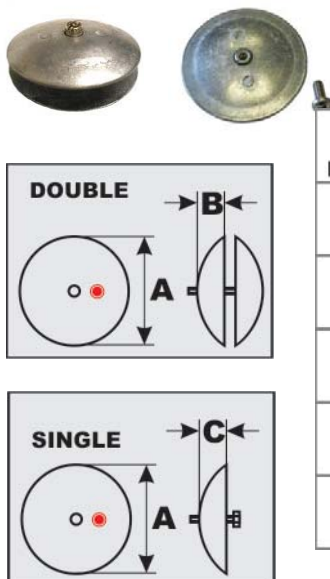



Part #	A	B	C	Weight	UPC
CM20A	20mm (0.79")	2 1/8" (54mm)	2 1/8" (54mm)	0.44 lbs (0.2Kg)	
CM25A	25mm (0.98")	2 1/8" (54mm)	2 1/8" (54mm)	0.4 lbs (0.18Kg)	
CM30A	30mm (1.18")	2 1/8" (54mm)	2 1/8" (54mm)	0.35 lbs (0.16Kg)	
CM35A	35mm (1.37")	2 1/2" (64mm)	2 1/2" (64mm)	0.6 lbs (0.27Kg)	
CM40A	40mm (1.57")	3 1/4" (83mm)	2 7/8" (73mm)	1.28 lbs (0.58Kg)	
CM45A	45mm (1.77")	3 1/4" (83mm)	2 7/8" (73mm)	1.15 lbs (0.52Kg)	
CM50A	50mm (1.97")	3 1/4" (83mm)	2 7/8" (73mm)	0.93 lbs (0.42Kg)	
CM60A	60mm (2.36")	4 1/4" (108mm)	3 3/4" (95mm)	2.23 lbs (1.0Kg)	
CM70A	70mm (2.76")	4 3/4" (121mm)	3 3/4" (95mm)	2.7 lbs (1.2Kg)	

# RUDDER/TRIM TAB ANODES

## RUDDER/TRIM TAB - DOUBLE and SINGLE



Part # DOUBLE	Part # SINGLE	A	B	Weight DOUBLE SINGLE	UPC DOUBLE "R"	UPC SINGLE "RH"
R1875A (R1)	RH1875A (R1)	1 7/8" (48mm)	1/4" (7mm)	0.1 lbs (0.03Kg) 0.05 lbs (0.02Kg)		
R2813A (R2)	RH2813A (R2)	2 13/16" (72mm)	1/2" (13mm)	0.33 lbs (0.15Kg) 0.17 lbs (0.08Kg)		
R3750A (R3)	RH3750A (R3)	3 3/4" (95mm)	1/2" (13mm)	0.6 lbs (0.27Kg) 0.3 lbs (0.14Kg)		
R5000A (R4)	RH5000A (R4)	5" (127mm)	5/8" (16mm)	1.82 lbs (0.83Kg) 0.9 lbs (0.41Kg)		
R6500A (R7)	RH6500A (R7)	6 1/2" (165mm)	7/8" (22mm)	3.6 lbs (1.63Kg) 1.8 lbs (0.82Kg)		

NOTE: PART # R1875A HAS NO WEAR INDICATOR

# BULK ANODES - Just Anodes



“Bulk” anodes are supplied without packaging, hardware or wear indicators.

Aluminum anodes are recommended for use in any water type.

Part #	Description	Weight	UPC
<b>BRP - OMC JOHNSON/EVINRUDE</b>			
B-00141A	Side Mounted (123009/327606/173029)	0.10 lbs (0.05 Kg)	8 70648 00319 6
B-00142A	Transom (392462)	0.70 lbs (0.32 Kg)	8 70648 00320 2
B-00143A	Transom (433580)	0.70 lbs (0.32 Kg)	8 70648 00321 9
B-00144A	Front Gearcase (398873)	0.15 lbs (0.07 Kg)	8 70648 00322 6
B-00145A	Prop Shaft (431708)	0.20 lbs (0.09 Kg)	8 70648 00323 3
B-00151A	Rear Gearcase (397768)	0.30 lbs (0.14 Kg)	8 70648 00324 0
B-00152A	Front Gearcase (983494)	0.65 lbs (0.30 Kg)	8 70648 00325 7
B-00153A	Front Gearcase (984513/3853818)	0.90 lbs (0.41 Kg)	8 70648 00326 4
B-00154A	Transom Mount (984547)	0.75 lbs (0.34 Kg)	8 70648 00327 1
B-00155A	Rear Gearcase (398331)	0.30 lbs (0.14 Kg)	8 70648 00328 8
B-00192A	Front Gearcase (392123)	0.70 lbs (0.32 Kg)	8 70648 00330 1
B-00201A	Cobra Rear Gear Case (436745/393023)	0.20 lbs (0.09 Kg)	8 70648 00329 5
B-00390A	Gearcase Anode (357507)	0.10 lbs (0.05 Kg)	8 70648 00446 9
B-00392A	Prop Anode (5009220)	0.50 lbs (0.23 Kg)	8 70648 00447 6
B-00393A	Gear Case Anode(355964)	0.30 lbs (0.14 Kg)	8 70648 00448 3
B-00394A	Gear Case Anode 20-3ohp (5007582)	0.20 lbs (0.09 Kg)	8 70648 00449 0

Part #	Description	Weight	UPC
<b>FLEX-O-FOLD</b>			
B-00685A	FX-112	0.45 lbs (0.20 Kg)	8 70648 00663 0
<b>HONDA</b>			
B-00027A	Small Plate Anode (41106-ZW9-000)	0.08lbs (0.04 Kg)	8 70648 00421 6
B-00028A	Stern Bracket Anode (06411-ZV5-000, 020)	0.32 lbs (0.15 Kg)	8 70648 00440 7
B-00029A	Outboard Trim Tab (41107-ZW1-B01ZA)	0.41 lbs (0.19 Kg)	8 70648 00441 4
B-00044A	Trim Tab (41107-ZW1-003ZA)	0.40 lbs (0.17 Kg)	8 70648 00230 4
B-00051A	Side Pocket Anode (41109-ZW1-003)	0.18 lbs (0.08 Kg)	8 70648 00237 3
B-00119A	Side Mounted (41106-935-812)	0.10 lbs (0.05 Kg)	8 70648 00307 3
B-00120A	Trim Tab (41107-ZV5-000)	0.25 lbs (0.11 Kg)	8 70648 00308 0
B-00197A	Stern Bracket (06411-ZV5-020)	0.30 lbs (0.12 Kg)	8 70648 00422 3
B-00198A	Side Pocket Anode Thin (41109-ZW1-B00)	0.40 lbs (0.17 Kg)	8 70648 00423 0
<b>MERCURY/MERCUISER</b>			
B-00041A	Cavitation Plate Alpha (821629T 1)	0.55 lbs (0.25 Kg)	8 70648 00227 4
B-00042A	Drive Trim Cylinder Alpha (806189T 1)	0.07 lbs (0.03 Kg)	8 70648 00228 1
B-00043A	Bearing Carrier Alpha (806105T 1)	0.17 lbs (0.08 Kg)	8 70648 00229 8
B-00044A	Trim Tab Anode (31640T 4)	0.40 lbs (0.18 Kg)	8 70648 00230 4
B-00045A	Gimbal Housing Block (821631T 1)	0.70 lbs (0.32 Kg)	8 70648 00231 1



# BULK ANODES - Just Anodes



Part #	Description	Weight	UPC
<b>MERCURY/MERCUISER CONTD.</b>			
B-00046A	Cavitation Plate Bravo (821630T 1)	0.80 lbs (0.36 Kg)	8 70648 100232 8
B-00047A	Drive Trim Cylinder Bravo (806190T 1)	0.27 lbs (0.12 Kg)	8 70648 100233 5
B-00048A	Bearing Carrier Bravo (806188A 1)	0.16 lbs (0.07 Kg)	8 70648 100234 2
B-00049A	Trim Tab Anode Flat (76214T 5)	0.25 lbs (0.11 Kg)	8 70648 100235 9
B-00050A	Gimbal Hsg Bolt Headnut (55989T 9)	0.15 lbs (0.07 Kg)	8 70648 100236 6
B-00051A	Side Pocket Anode (826134T)	0.18 lbs (0.08 Kg)	8 70648 100237 3
B-00052A	Power Trim Anode (818298T 1)	0.50 lbs (0.23 Kg)	8 70648 100238 0
B-00093A	Manifold Anode (880653)	0.48 lbs (0.22 Kg)	8 70648 100298 4
B-00094A	Trim Cylinder Verado (893404)	0.10 lbs (0.05 Kg)	8 70648 100299 1
B-00163A	Prop Anode (865182A 1)	0.40 lbs (0.18 Kg)	8 70648 100239 7
B-00196A	Prop Anode Retrofit	0.60 lbs (0.27 Kg)	8 70648 100300 4
B-00222A	Gear Housing Anode (42121Q02)	0.03 lbs (0.01 Kg)	8 70648 100424 7
B-00223A	Trim Tab 9.9-25hp (98432Q6)	0.40 lbs (0.18 Kg)	8 70648 100425 4
B-00224A	Round Anode 4-30hp (823912)	0.04 lbs (0.02 Kg)	8 70648 100426 1
B-00225A	Bar Anode 25-40hp (825271 1)	0.24 lbs (0.11 Kg)	8 70648 100427 8
B-00226A	Square Block 4-9.9hp (875208)	0.06 lbs (0.03 Kg)	8 70648 100428 5
B-00268A	Trim Tab Flat Recessed (76214 4)	0.25 lbs (0.11 Kg)	8 70648 100300 4

Part #	Description	Weight	UPC
<b>MERCURY/MERCUISER CONTD.</b>			
B-00380A	Trim Tab Anode 25-50hp (822157T 2)	0.50 lbs (0.23 Kg)	8 70648 100660 9
<b>SUZUKI</b>			
B-00344A	Round Anode (55321-87J00)	0.02 lbs (0.01 Kg)	8 70648 100439 1
B-00351A	Outboard Anode (55125-95500)	0.16 lbs (0.07 Kg)	8 70648 100429 2
B-00352A	20-35hp Trim Tab Anode (55125-96310)	0.10 lbs (0.05 Kg)	8 70648 100430 8
B-00353A	Outboard Bar Anode (55320-94900)	0.40 lbs (0.18 Kg)	8 70648 100431 5
B-00354A	Small Block Anode (55320-95311)	0.07 lbs (0.03 Kg)	8 70648 100432 2
B-00355A	Outboard Anode (55321-90J01)	0.07 lbs (0.03 Kg)	8 70648 100433 9
B-00356A	9.9-15hp Outboard Anode (55321-93900)	0.05 lbs (0.02 Kg)	8 70648 100434 6
<b>VETUS</b>			
B-00671A	Vetus SET0150 Bow Thruster 75/80/95	0.15 lbs (0.07 Kg)	8 70648 100661 6
<b>VOLVO PENTA</b>			
B-00110A	Side Mounted - SX, DP-X (872793-5)	0.10 lbs (0.05 Kg)	8 70648 100254 0
B-00111A	Anodic Bar (832598-7)	0.80 lbs (0.36 Kg)	8 70648 100255 7
B-00112A	Anodic Bar (852835-8)	0.70 lbs (0.32 Kg)	8 70648 100256 4
B-00113A	Prop Ring - V15 (875810-4)	0.20 lbs (0.09 Kg)	8 70648 100257 1
B-00114A	Prop Ring - V17 (875806-4)	0.30 lbs (0.14 Kg)	8 70648 100258 8

# BULK ANODES - Just Anodes



Part #	Description	Weight	UPC
<b>VOLVO PENTA CONTD.</b>			
B-00115A	Prop Ring - V16 (875810-4)	0.20 lbs (0.09 Kg)	8 70648 100259 5
B-00116A	Prop Ring - Duo Prop	0.50 lbs (0.23 Kg)	8 70648 100260 1
B-00117A	Gimbal Plate - SX (3854130)	1.00 lbs (0.45 Kg)	8 70648 100261 8
B-00118A	Anodic Bar (872139)	0.60 lbs (0.27 Kg)	8 70648 100262 5
B-00156A	Transom DPS-A/SX-A (3841427/3888816)	1.10 lbs (0.50 Kg)	8 70648 100266 3
B-00157A	Gearhouse DPS-A/SX-A (3883728/3888813)	1.50 lbs (0.70 Kg)	8 70648 100267 0
B-00158A	DPX Outdrive Cube (873395)	0.30 lbs (0.15 Kg)	8 70648 100303 5
B-00160A	Prop Ring - 110 Sail Drive (875812)	0.80 lbs (0.36 Kg)	8 70648 100263 2
B-00161A	Prop Ring - V18 (875815)	0.60 lbs (0.27 Kg)	8 70648 100264 9
B-00162A	Transom Plate - SX (3855411)	0.90 lbs (0.41 Kg)	8 70648 100265 6
B-00218A	Cavitation Plate - DPH/DPR	0.90 lbs (0.41 Kg)	8 70648 100305 9
B-00219A	Transom Shield - SX (3855411)	0.90 lbs (0.41 Kg)	8 70648 100306 6
<b>YAMAHA</b>			
B-00119A	Side Mounted (6E0-45251-11)	0.10 lbs (0.05 Kg)	8 70648 100307 3
B-00120A	Trim Tab (664-45371-01)	0.30 lbs (0.14 Kg)	8 70648 100308 0
B-00121A	Trim Tab (6K1-45371-00)	0.40 lbs (0.18 Kg)	8 70648 100309 7
B-00122A	Trim Tab (6E5-45371-01)	0.40 lbs (0.18 Kg)	8 70648 100310 3
B-00123A	Trim Tab (688-45371-02)	0.40 lbs (0.18 Kg)	8 70648 100311 0

Part #	Description	Weight	UPC
<b>YAMAHA CONTD.</b>			
B-00124A	Block (6E5-45251-00)	0.15 lbs (0.07 Kg)	8 70648 100312 7
B-00125A	Trim Tab (6J9-45371-01)	0.60 lbs (0.27 Kg)	8 70648 100313 4
B-00126A	Transom (6H1-45251-02)	0.45 lbs (0.20 Kg)	8 70648 100314 1
B-00127A	Transom (6G5-45251-02)	0.80 lbs (0.36 Kg)	8 70648 100315 8
B-00128A	Block (688-45251-01)	0.04 lbs (0.02 Kg)	8 70648 100316 5
B-00180A	Trim Tab 200, 225, 250 4 stroke (61A-45371-00)	0.60 lbs (0.27 Kg)	8 70648 100317 2
B-00181A	Trim Tab 150 HP ctr rot (6K1-45371-02)	0.60 lbs (0.27 Kg)	8 70648 100318 9
B-00185A	Trim Tab 200-300hp 2 Stroke (69L-45371-00)	0.80 lbs (0.36 Kg)	8 70648 100331 8
B-00357A	Outboard Bracket Anode (6AW-45251-00)	0.58 lbs (0.26 Kg)	8 70648 100331 8
B-00358A	Lower Unit Anode (6AW-45373-00)	0.90 lbs (0.41 Kg)	8 70648 100331 8
B-00359A	Clamp Bracket Anode 8-250hp (65W-45251-00-00)	0.09 lbs (0.04 Kg)	8 70648 100331 8
B-00360A	Outboard Cube Anode 25-60hp (67C-45251-00)	0.07 lbs (0.03 Kg)	8 70648 100331 8
B-00361A	Bracket Anode (63D-45251-01)	0.50 lbs (0.23 Kg)	8 70648 100331 8
B-00362A	Outboard Cover Anode (6AW-45619-00)	0.25 lbs (0.11 Kg)	8 70648 100331 8
B-00363A	Outboard Internal Anode (67F-11325-01)	0.10 lbs (0.05 Kg)	8 70648 100331 8
B-00364A	Trim Tab 50-100hp (67F-45371-00)	0.42 lbs (0.19 Kg)	8 70648 100331 8
<b>YANMAR</b>			
B-00035A	Saildrive Split Ring Anode (196440-02660)	0.73 lbs (0.33 Kg)	8 70648 100662 3

# ENGINE COOLING PENCIL ANODES

**SecureCore®**

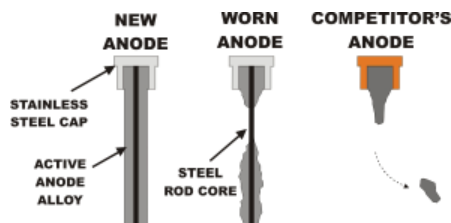

SecureCore anodes have a central core which prevents a wasted end from falling off and blocking waterways etc.



## ANODE ONLY

Part #		Dia.	Length	Thread UNC	UPC
AE-0	in	3/8	1 3/4	5/16-18	8 70648 100502 2
	mm	9.5	44.5		
AE-0A	in	3/8	2 1/2	5/16-18	8 70648 100503 9
	mm	9.5	63.5		
AE-0B	in	3/8	3/4	5/16-18	8 70648 100504 6
	mm	9.5	19.1		
AE-1	in	1/2	2	3/8-16	8 70648 100505 3
	mm	12.7	50.8		
AE-1D	in	1/2	1 3/4	3/8-16	8 70648 100506 0
	mm	12.7	44.5		
AE-1E	in	1/2	1 1/2	3/8-16	8 70648 100507 7
	mm	12.7	38.1		
AE-1F	in	1/2	1 1/4	3/8-16	8 70648 100508 4
	mm	12.7	31.8		
AE-1G	in	1/2	1	3/8-16	8 70648 100509 1
	mm	12.7	25.4		
AE-1H	in	1/2	1 5/8	3/8-16	8 70648 100510 7
	mm	12.7	41.3		
AE-1J	in	1/2	5/8	3/8-16	8 70648 100511 4
	mm	12.7	15.9		
AE-2	in	5/8	2	7/16-14	8 70648 100512 1
	mm	15.9	50.8		
AE-2A	in	5/8	1 1/4	7/16-14	8 70648 100513 8
	mm	15.9	31.8		
AE-2B	in	5/8	3	7/16-14	8 70648 100514 5
	mm	15.9	76.2		
AE-2D	in	5/8	1 3/4	7/16-14	8 70648 100515 2
	mm	15.9	44.5		
AE-3	in	3/4	2	1/2-13	8 70648 100516 9
	mm	19.1	50.8		
AE-3A	in	3/4	3/4	1/2-13	8 70648 100517 6
	mm	19.1	19.1		
AE-4	in	3/4	3 3/8	1/2-13	8 70648 100518 3
	mm	19.1	85.8		
AE-5	in	3/4	3 5/8	1/2-13	8 70648 100519 0
	mm	19.1	92.1		
AE-6	in	3/4	4 3/4	1/2-13	8 70648 100520 6
	mm	19.1	120.7		

Part #		Dia.	Length	Thread UNC	UPC
AE-6A	in	13/16	7	1/2-13	8 70648 100521 3
	mm	20.6	177.9		
AE-7	in	1 1/16	5	3/4-10	8 70648 100522 0
	mm	27.0	127.1		
AE-7A	in	1 1/16	10	3/4-10	8 70648 100523 7
	mm	27.0	254.1		
AE-7B	in	1	14	3/4-10	8 70648 100524 4
	mm	25.4	355.7		
AE-7D	in	1	16	3/4-10	8 70648 100525 1
	mm	25.4	406.6		
AE-8	in	1 1/4	2 5/16	3/4-10	8 70648 100526 8
	mm	31.8	58.8		
AE-8A	in	1 1/16	6	3/4-10	8 70648 100527 5
	mm	27.0	152.5		
AE-8B	in	1 1/16	10	3/4-10	8 70648 100528 2
	mm	27.0	254.1		
AE-8D	in	1 1/4	2 1/8	3/4-10	8 70648 100529 9
	mm	31.8	54.0		
AE-8E	in	1	14	3/4-10	8 70648 100530 5
	mm	25.4	355.7		
AE-8F	in	1	16	3/4-10	8 70648 100531 2
	mm	25.4	406.6		
A 6L2016	in	3/4	3/4	1/2-13	8 70648 100532 9
	mm	19.1	19.1		
A 6L2280	in	1/2	1 5/8	3/8-16	8 70648 100533 6
	mm	12.7	41.3		
A 6L2283	in	3/8	2 1/2	5/16-18	8 70648 100534 3
	mm	9.5	63.5		
A 6L2284	in	1 1/4	2 1/8	3/4-10	8 70648 100535 0
	mm	31.8	54.0		
A 6L2285	in	1 1/4	2 1/3	3/4-10	8 70648 100536 7
	mm	31.8	58.8		
A 6L2288	in	5/8	2 1/2	3/8-16	8 70648 100537 4
	mm	15.9	63.5		
A 6L2289	in	5/8	3	7/16-14	8 70648 100538 1
	mm	15.9	76.2		
A 6L3104 (AE-0C)	in	3/8	1 1/2	1/4-20	8 70648 100539 4
	mm	9.5	38.1		

# ENGINE COOLING PENCIL ANODES

**SecureCore®**



SecureCore® anodes are made from aluminum alloy which is more active and longer lasting than zinc. It is suitable for use in all types of water. It is a better alloy in hot water than zinc. The plugs are made from 304

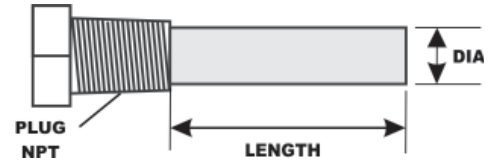

## COMPLETE ANODE WITH PLUG

Part #		Dia.	Length	Plug NPT	UPC
CE-0	in	3/8	1 3/4	1/4	8 70648 000541 1
	mm	9.5	44.5		
CE-0A	in	3/8	2 1/2	1/4	8 70648 000542 8
	mm	9.5	63.5		
CE-0B	in	3/8	3/4	1/4	8 70648 000543 5
	mm	9.5	19.1		
CE-1	in	1/2	2	3/8	8 70648 000544 2
	mm	12.7	50.8		
CE-1D	in	1/2	1 3/4	3/8	8 70648 000545 9
	mm	12.7	44.5		
CE-1E	in	1/2	1 1/2	3/8	8 70648 000546 6
	mm	12.7	38.1		
CE-1F	in	1/2	1 1/4	3/8	8 70648 000547 3
	mm	12.7	31.8		
CE-1G	in	1/2	1	3/8	8 70648 000548 0
	mm	12.7	25.4		
CE-1H	in	1/2	1 5/8	3/8	8 70648 000549 7
	mm	12.7	41.3		
CE-1J	in	1/2	5/8	3/8	8 70648 000550 3
	mm	12.7	15.9		
CE-2	in	5/8	2	1/2	8 70648 000551 0
	mm	15.9	50.8		
CE-2A	in	5/8	1 1/4	1/2	8 70648 000552 7
	mm	15.9	31.8		
CE-2B	in	5/8	3	1/2	8 70648 000553 4
	mm	15.9	76.2		
CE-2D	in	5/8	1 3/4	1/2	8 70648 000554 1
	mm	15.9	44.5		
CE-3	in	3/4	2	3/4	8 70648 000555 8
	mm	19.1	50.8		
CE-3A	in	3/4	3/4	3/4	8 70648 000556 5
	mm	19.1	19.1		
CE-4	in	3/4	3 3/8	3/4	8 70648 000557 2
	mm	19.1	85.8		
CE-5	in	3/4	3 5/8	3/4	8 70648 000558 9
	mm	19.1	92.1		
CE-6	in	3/4	4 3/4	3/4	8 70648 000559 6
	mm	19.1	120.7		

Part #		Dia.	Length	Plug NPT	UPC
CE-6A	in	13/16	7	3/4	8 70648 000560 2
	mm	20.6	177.9		
CE-7	in	1 1/16	5	1	8 70648 000561 9
	mm	27.0	127.1		
CE-7A	in	1 1/16	10	1	8 70648 000562 6
	mm	27.0	254.1		
CE-7B	in	1	14	1	8 70648 000563 3
	mm	25.4	355.7		
CE-7D	in	1	16	1	8 70648 000564 0
	mm	25.4	406.6		
CE-8	in	1 1/4	2 5/16	1 1/4	8 70648 000565 7
	mm	31.8	58.8		
CE-8A	in	1 1/16	6	1 1/4	8 70648 000566 4
	mm	27.0	152.5		
CE-8B	in	1 1/16	10	1 1/4	8 70648 000567 1
	mm	27.0	254.1		
CE-8D	in	1 1/4	2 1/8	1 1/4	8 70648 000568 8
	mm	31.8	54.0		
CE-8E	in	1	14	1 1/4	8 70648 000569 5
	mm	25.4	355.7		
CE-8F	in	1	16	1 1/4	8 70648 000570 2
	mm	25.4	406.6		
C 6L2016	in	3/4	3/4	3/4	8 70648 000571 8
	mm	19.1	19.1		
C 6L2280	in	1/2	1 5/8	3/8	8 70648 000572 5
	mm	12.7	41.3		
C 6L2283	in	3/8	2 1/2	1/4	8 70648 000573 2
	mm	9.5	63.5		
C 6L2284	in	1 1/4	2 1/8	1 1/4	8 70648 000574 9
	mm	31.8	54.0		
C 6L2285	in	1 1/4	2 1/3	1 1/4	8 70648 000575 6
	mm	31.8	58.8		
C 6L2288	in	5/8	2 1/2	1/2	8 70648 000576 3
	mm	15.9	63.5		
C 6L2289	in	5/8	3	1/2	8 70648 000577 0
	mm	15.9	76.2		
C 6L3104 (CE-0C)	in	3/8	1 1/2	1/4	8 70648 000657 9
	mm	9.5	38.1		

# ANODE INDEX - OEM to PM Cross Reference

OEM Part #	PM Part #	Page	OEM Part #	PM Part #	Page	OEM Part #	PM Part #	Page
<b>PREMIUM DRIVE KITS</b>			<b>Suzuki</b>			Diver		
Packaged kits with hardware			Drive Kits			DOK		
<b>Beneteau</b>			55125-95500			Mini Diver		
22/25 mm	00350A	24	55125-96310	00352A	14	N1	HN1A	25
<b>BRP</b>			55320-94900			SZ-1		
Drive Kits			55320-95311			OEM Part #		
123009	00141A	5	55321-87J00			PM Part #		
173029	00141A	5	55321-90J01			ZHC-2		
327606	00141A	5	55321-93900			ZHC-3		
355964	00393A	7	<b>Vetus</b>			ZHC-5		
357507	00390A	6	SET0150			HC2A		
392123	00192A	6	Volvo Penta			HC3A		
392462	00142A	5	Drive Kits			HC5A		
393023	00201A	6	872139			<b>Power Series</b>		
397768	00151A	6	873395			HYAA		
398331	00155A	6	875812			<b>European Hull Anodes</b>		
398873	00144A	5	875815			HE002A		
431708	00145A	5	3588745			HE002A-A		
433458	00155A	6	3588748			HE005A		
433580	00143A	5	3841427			HE005A-A		
434029	00394A	7	3854130			HE010A		
436745	00201A	6	3855411			HE010A-A		
983494	00152A	6	3883728			HE020A		
984513	00153A	6	3888813			HE020A-A		
984547	00154A	6	875810-4			HE035A		
3853818	00153A	6	875810-4			HE035A-A		
5007582	00394A	7	875821-1			HE055A		
5009220	00392A	7	D2/D4			HE055A-A		
<b>Flex-o-Fold</b>			<b>Yamaha</b>			<b>Suspended Anodes</b>		
FX-112			Drive Kits			HE020AW		
00685A		7	61A-45371-00			HE055AW		
<b>Frigoboat</b>			Drive Kits			<b>Commercial Hull Anodes</b>		
E-51525			63D-45251-01			AHS-10		
F1549		24	65W-45251-00			HS23A-S		
<b>Honda</b>			664-45371-01			D56		
Drive Kits			67C-45251-00			HD56A		
06411-ZV5-000, 020	00028A	8	67F-11325-01			D72BM		
06411-ZV5-020	00197A	8	67F-45371-00			D77		
41106-935-812	00199A	8	688-45251-01			D78B		
41106-ZW9-000	00027A	8	688-45371-02			HC23		
41107-ZV5-000	00120A	8	69L-45371-00			HS23		
41107-ZW1-003ZA	00044A	8	6AW-45251-00			LHS-10		
41107-ZW1-B01ZA	00029A	8	6AW-45373-00			HA3A-S		
41109-ZW1-003	00051A	8	6AW-45619-00			HA3A-A		
41109-ZW1-B00	00198A	9	6E0-45251-11					
<b>Mercury/Mercuriser</b>			<b>Yanmar</b>			<b>SHAFT ANODES</b>		
Drive Kits			196440-02660			<b>Collar - Reduced Clearance</b>		
9 - 10, 12			00035A			C1		
31640	00044A	10, 12	<b>HULL ANODES</b>			C2		
42121	00222A	13	Hull Strainer			C3		
55989	00050A	11	Aluminum Hull Anodes			C4		
98432	00223A	13	A24			C5		
762144	00268A	11	A25			C6		
762145	00049A	11, 12	A30			C7		
806105	00043A	10	A40			C8		
806188	00048A	11	A90			C9		
806189	00042A	10	B12			C11		
806190	00047A	11	Bennett			RC0750A		
818298	00052A	12	HBNTA			RC0875A		
821629	00041A	10				RC1000A		
821630	00046A	11				RC1250A		
821631	00045A	10				RC1375A		
822157	00380A	13				RC1500A		
823912	00224A	13				RC1750A		
825271	00225A	13				RC2000A		
826134	00051A	12				RC2250A		
865182	00163A	11				<b>Collar - Reduced Clearance - Metric</b>		
875208	00226A	13				20 mm Red Clrnc		
880653	00093A	13				25 mm Red Clrnc		
893404	00094A	13				30 mm Red Clrnc		
	00196A	11				35 mm Red Clrnc		
						40 mm Red Clrnc		
						45 mm Red Clrnc		
						50 mm Red Clrnc		
						60 mm Red Clrnc		
						<b>Streamlined Collar</b>		
						1/2" Stream		
						5/8" Stream		
						X1		
						X2		
						X3		
						X4		
						X5		
						1 1/4" (large) Stream		

# ANODE INDEX - OEM to PM Cross Reference

OEM Part #	PM Part #	Page	OEM Part #	PM Part #	Page	OEM Part #	PM Part #	Page
X6	C1375A	30	<b>Bulk Commercial - Mercury</b>			67C-45251-00	B-00360A	34
X7	C1500A	30	31640	B-00044A	32	67F-11325-01	B-00363A	34
X8	C1750A	30	42121	B-00222A	33	67F-45371-00	B-00364A	34
X9	C2000A	30	55989	B-00050A	33	6AW-45373-00	B-00358A	34
X10	C2250A	30	98432	B-00223A	33	6AW-45619-00	B-00362A	34
X11	C2500A	30	762144	B-00268A	33	<b>Bulk Commercial - Yanmar</b>		
X12	C2750A	30	762145	B-00049A	33	196440-02660	B-00035A	34
X13	C3000A	30	806105	B-00043A	32			
<b>Streamlined Collar - Metric</b>			806188	B-00048A	33			
20 mm Stream	CM20A	31	806189	B-00042A	32			
25 mm Stream	CM25A	31	806190	B-00047A	33			
30 mm Stream	CM30A	31	818298	B-00052A	33			
35 mm Stream	CM35A	31	821629	B-00041A	32			
40 mm Stream	CM40A	31	821630	B-00046A	33			
45 mm Stream	CM45A	31	821631	B-00045A	32			
50 mm Stream	CM50A	31	822157	B-00380A	33			
60 mm Stream	CM60A	31	823912	B-00224A	33			
70 mm Stream	CM70A	31	825271	B-00225A	33			
<b>TRIM TAB/RUDDER ANODES</b>			826134	B-00051A	33			
<b>Trim Tab/Rudder</b>			865182	B-00163A	33			
R1	R1875A	31	875208	B-00226A	33			
R2	R2813A	31	880653	B-00093A	33			
R3	R3750A	31	893404	B-00094A	33			
R4	R5000A	31						
R7	R6500A	31	<b>Bulk Commercial Suzuki Anodes</b>					
R1 Half	RH1875A	31	55125-95500	B-00351A	33			
R2 Half	RH2813A	31	55125-96310	B-00352A	33			
R3 Half	RH3750A	31	55320-94900	B-00353A	33			
R4 Half	RH5000A	31	55320-95311	B-00354A	33			
R7 Half	RH6500A	31	55321-87J00	B-00344A	33			
<b>Teardrop Anodes</b>			55321-90J01	B-00355A	33			
3 1/2"	T20A	26	55321-93900	B-00356A	33			
5 1/4"	T21A	27						
	BULK							
<b>BULK ANODES</b>								
Anodes only - No hardware or wear indicators								
<b>Bulk Commercial - BRP</b>								
173029	B-00141A	32	<b>Bulk Commercial - Volvo</b>					
355964	B-00393A	32	872139	B-00118A	34			
357507	B-00390A	32	873395	B-00158A	34			
392123	B-00192A	32	875812	B-00160A	34			
392462	B-00142A	32	875815	B-00161A	34			
397768	B-00151A	32	3588745	B-00219A	34			
398331	B-00155A	32	3588748	B-00218A	34			
398873	B-00144A	32	3841427	B-00156A	34			
431708	B-00145A	32	3854130	B-00117A	34			
433580	B-00143A	32	3855411	B-00162A	34			
436745	B-00201A	32	3888813	B-00157A	34			
983494	B-00152A	32	832598-7	B-00111A	33			
984547	B-00154A	32	852835-8	B-00112A	33			
3853818	B-00153A	32	872793-5	B-00110A	33			
5007582	B-00394A	32	875805-4	B-00114A	33			
5009220	B-00392A	32	875809-6	B-00115A	34			
<b>Bulk Commercial - Flex-O-Fold</b>			875810-4	B-00113A	33			
FX-112	B-00685A	32	875821-1	B-00116A	33			
<b>Bulk Commercial - Honda</b>			<b>Bulk Commercial - Yamaha</b>					
06411-ZV5-000,020	B-00028A	32	61A-45371-00	B-00180A	34			
06411-ZW1-020	B-00197A	32	664-45371-01	B-00120A	34			
41106-935-812	B-00119A	32	688-45251-01	B-00128A	34			
41106-ZW9-000	B-00027A	32	688-45371-02	B-00123A	34			
41107-ZV5-000	B-00120A	32	69L-45371-00	B-00185A	34			
41107-ZW1-003ZA	B-00044A	32	6AW-45251-00	B-00357A	34			
41107-ZW1-B01ZA	B-00029A	32	6E0-45251-11	B-00119A	34			
41109-ZW1-003	B-00051A	32	6E5-45251-00	B-00124A	34			
41109-ZW1-B00	B-00198A	32	6E5-45371-01	B-00122A	34			
			6G5-45251-01	B-00127A	34			
			6H1-45251-02	B-00126A	34			
			6J9-45371-00	B-00125A	34			
			6K1-45371-00	B-00121A	34			
			6K1-45371-02	B-00181A	34			
			63D-45251-01	B-00361A	34			
			65W-45251-00	B-00359A	34			

WWW.PERFORMANCEMETALS.COM

Visit our Web Site [www.performancemetals.com](http://www.performancemetals.com)

Packed with information:

Advantages of Navalloy®

Anode Home Page

Frequently Asked Questions

Distribution

Product Range

Product Details

Reference Documents

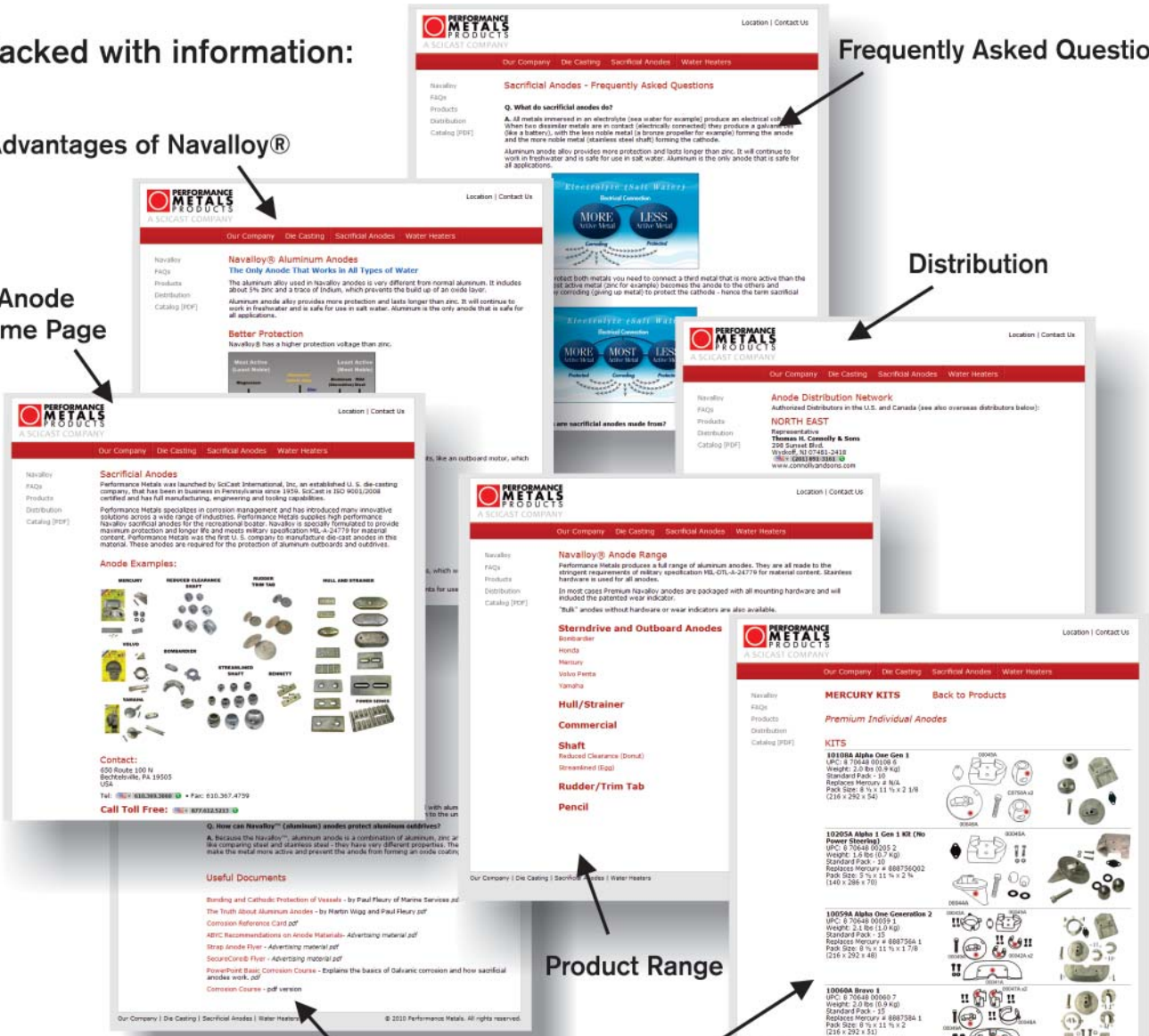

The web site has information and advice about corrosion, bonding, anode selection and a host of other subjects.



## Aluminum Sacrificial Anodes

PERFORMANCE  
METALS



SHAFT • RUDDER • HULL • STERNDRIVE • OUTBOARD • INBOARD • STRAP • PENCIL •



Performance Metals 2 Washington Street, Cambridge, MD 21613  
USA: +1-410.228.2400 : Fax +1 410.228.5079  
email: [contact@performancemetals.com](mailto:contact@performancemetals.com)

September 2019 Edition