

A STRONG SUPPORT FOR ALL PURPOSE

RAKEGO



ROCA[®]



rocaindustry.com

Rakego folding bracket

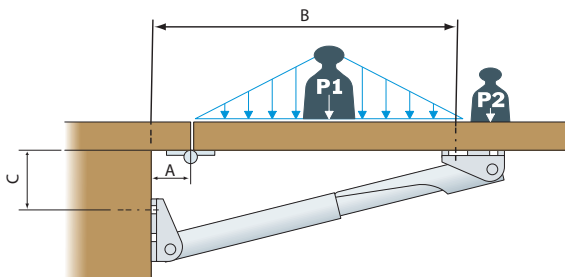

P1 = EVENLY DISTRIBUTED LOAD
P2 = POINT LOAD

- Easy to fold
- For drop leaf up to 600 mm
- Load capacity up to 140 kg
- Material for harsh conditions
- Elegant and compact design

Hints how to choose Rakego support:

	200	300	450	600
Ø20	382020	383020	384520	386020
Ø25	382025	383025	384525	386025

Some examples , the possibilities are unlimited:

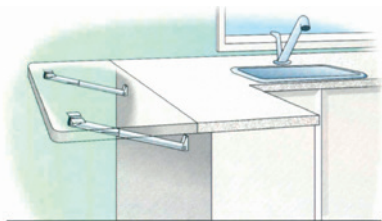

Extra working space in the kitchen

Size of the bench $\approx 130 \times 70$ cm.
 Mount 2 pcs Rakego 386025.

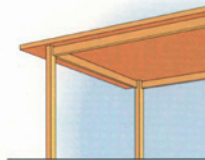

Kitchen table, with sitting room table

Size of the section \approx
 Mount 1 pcs Rakego

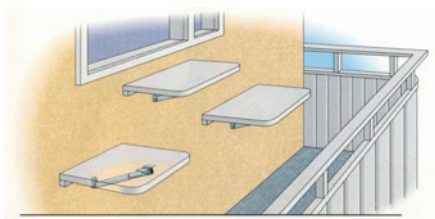

Balcony table and chairs.

Size of the table $\approx 50 \times 50$ cm.
 Mount 1 pcs Rakego 384520.
 Size of the chair $\approx 50 \times 50$ cm.
 Mount 1 pcs Rakego 383025.

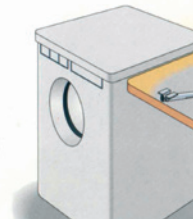

Extra space in the

Size of the bench \approx
 Mount 2 pcs Rakego

To fold:

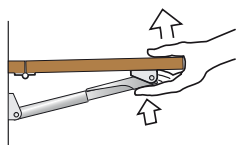

1.

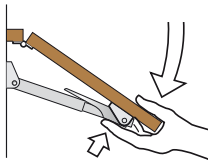

2.



3.

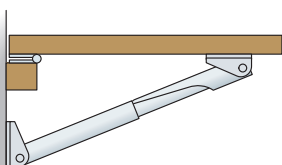

Heavy loading

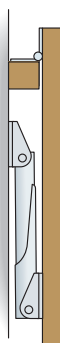

Material:

Aluminum (AA6061)
Stainless steel (AISI304)

Treatment:

Natural anodized

Item no:

See table

Item no:	A (mm)	B (mm)	C (mm)	P1 (kg)	P2 (kg)
382020	23-30	150	14	60	30
382025	28-30	161	15	70	35
383020	23-35	247	44	60	30
383025	28-39	252	45	95	55
384520	23-46	392	86	60	30
384525	28-50	402	87	120	60
386020	23-40	544	136	60	30
386025	28-40	549	137	140	80



Writing desk or

80 x 70 cm.
384525.

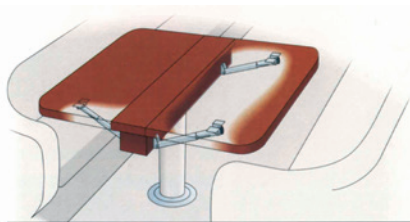

A table for boat, trailer or camper.

Left section size $\approx 120 \times 28$ cm.
Mount 2 pcs Rakego 382020.
Right section size $\approx 120 \times 40$ cm.
Mount 2 pcs Rakego 382020.

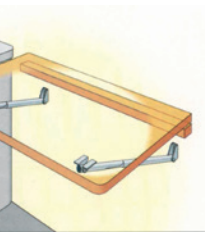

Workbench in the laundry room.

80 x 60 cm.
386020.

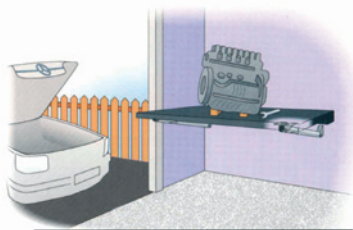

**Work bench in the garage,
packaging bench in the workshop.**

Size of the bench $\approx 150 \times 60$ cm.
Mount 2 pcs Rakego 386025.

Rakego Lid stay



- Can be mounted for different angle positions.
- Left or right hand installation possible
- For both vertical and horizontal lids
- Distinct push knob to release
- Load capacity 50 Nm
- Material for harsh conditions

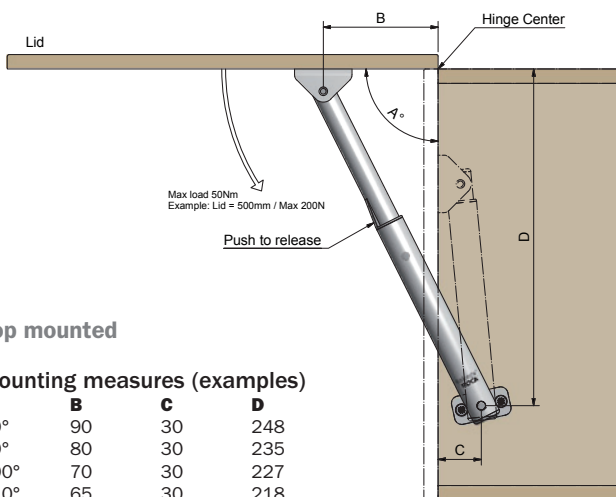

Top mounted

Mounting measures (examples)

A°	B	C	D
80°	90	30	248
90°	80	30	235
100°	70	30	227
110°	65	30	218

Flush mounted

Mounting measures (examples)

T	A°	B	C	D
10	80°	90	50	246
10	90°	80	40	239
10	100°	75	40	227
10	110°	65	40	221
15	80°	90	50	251
15	90°	80	40	244
15	100°	75	40	231
15	110°	65	40	225

Material:

Aluminum (AA6061)
Plastic (POM)
Stainless steel (AISI304)

Treatment:

Natural anodized

Item no:

389620

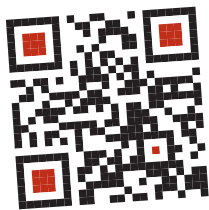
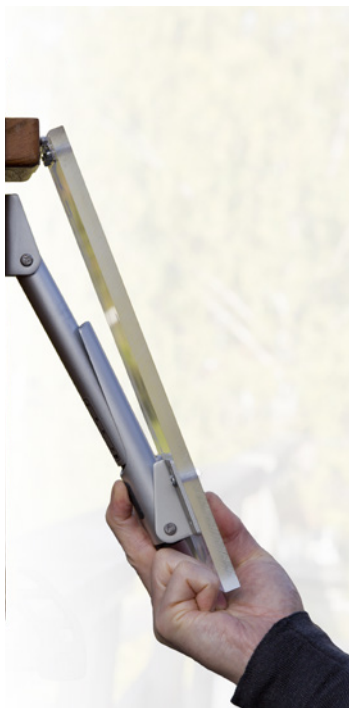

» See Rakego movie on YouTube



Lid stay



Lid stay





The Roca  stands for quality, design and stainless performance. Since more than 30 years Roca Industry is producing stainless products for demanding applications.

rocaindustry.com