

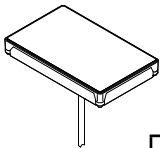



Part List	
	Hidden 3 Coil x1
	Compression puck x1
	Mounting bracket x1

Tools Required	
	Jig Saw
	File
	Glue (Optional)
	Pan head screw (Optional)

Technical	
IP Waterproof Rating	IPX6 Front and back
Input voltage	10-30V DC (12/24V System)
Input current max	2A
Output power max	15W (12V 1.25A)
Standby power max	<1.2W
Certification	CE, UKCA, FCC, ROHS, C-Tick, UN ECE R10, E24, PSE Certified

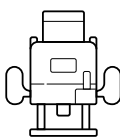

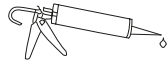
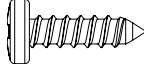
READ THE IMPORTANT SAFETY INFORMATION LEAFLET BEFORE INSTALLING.

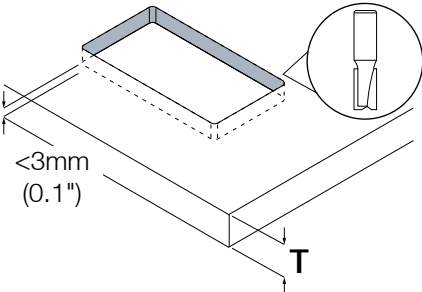

①
If the mounting surface (**T**) is $>3\text{mm}$ (0.1"). Rout a pocket on the underside using the template as a guide. Rout the profile until $<3\text{mm}$ thickness is achieved.

②

- Clean the top and underside surfaces.
- Align the installation tool centrally with the sticker.
- Remove the adhesive backing from the grip ring and apply.
- Remove the alignment tools.

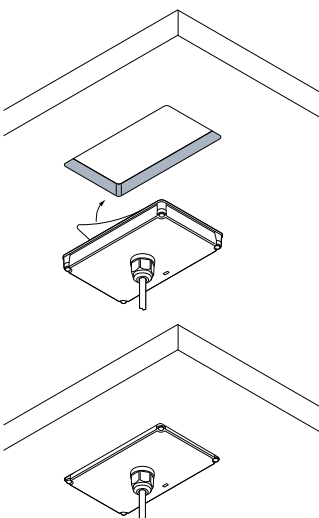

③
- Remove adhesive backing from the charger and apply.

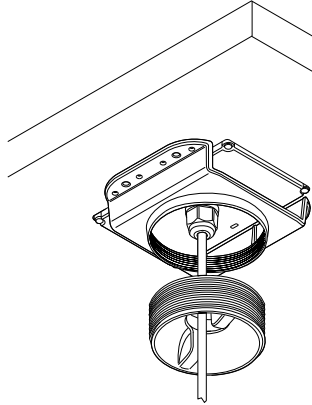

④

- Screw OR glue mounting bracket into place. (Fixings not included).
- Screw the puck into the mounting bracket until it compresses the charger. (Do not over tighten)

⑤

- Connect wires or connectors to 12/24V supply, ensuring a waterproof connection.
- Fuse according to input voltage and current.

○ White LED Constant: ON Charge

● Red LED Constant: Standby (power ON)

☀ Red LED Flashing:

Foreign object detection: metallic object placed on top that is not Qi compatible.

OR

Thermal cutout: The internal temperature is too high/ low. Wait for product to return to operating temperature.

UK & International For further installation and warranty information USA
 +44 (0)1392531280 please visit: +1 860 308 1416
 sales@scanstrut.com www.scanstrut.com usasales@scanstrut.com



Routing Template 1:1

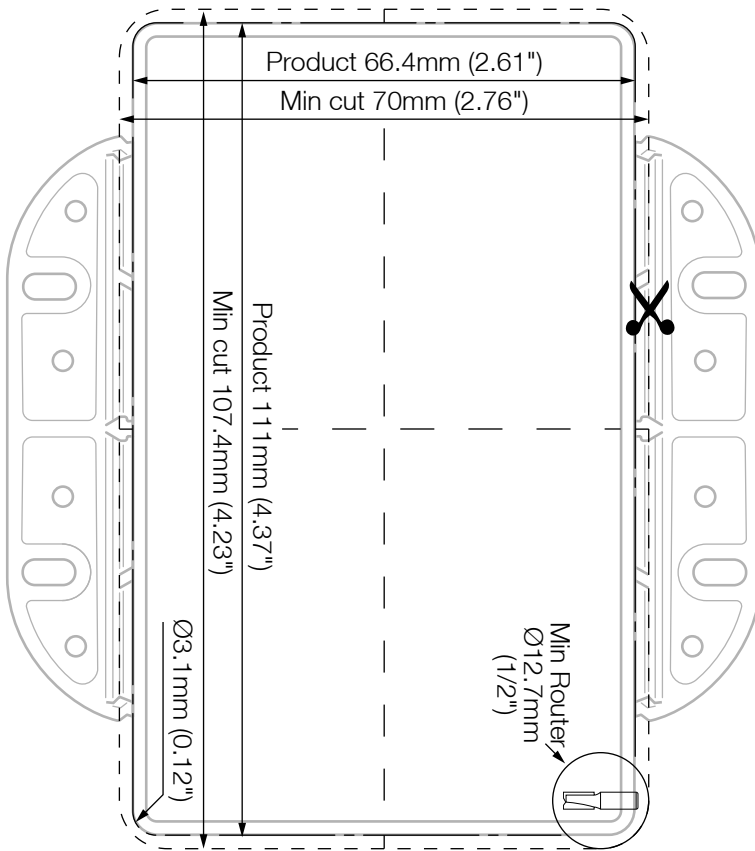

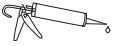
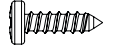
Recommended Fixing Method (Not included)		Mounting Thickness (T)
	Adhesive	<12.7mm (1/2")
	No.6 Pan Head screw min 12.7mm (1/2")	>12.7mm (1/2")



Print document 1:1 scale for correct cutting template size. Paper Size A4

Warning Check Scale

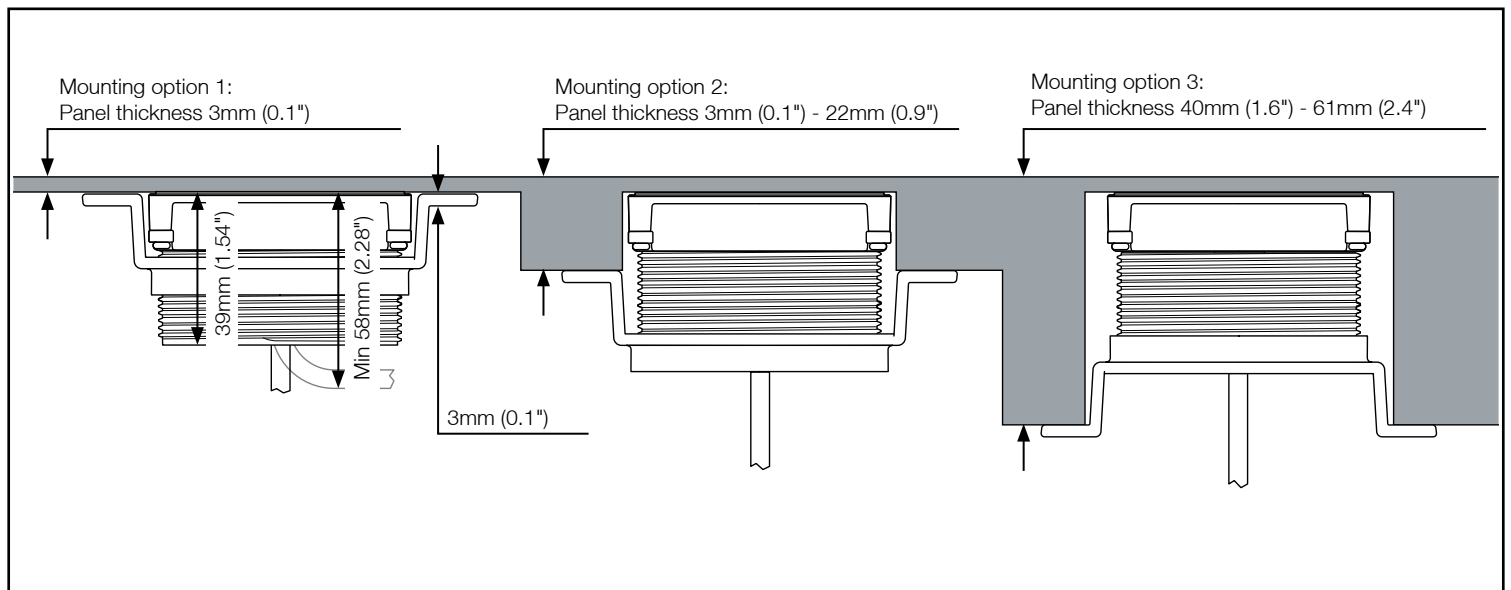
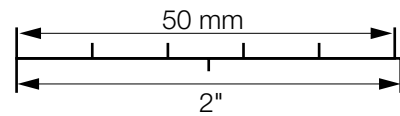

UK & International
+44 (0)1392531280
sales@scanstrut.com

For further installation
and warranty information
please visit:
www.scanstrut.com

USA
+1 860 308 1416
usasales@scanstrut.com

