



SHURFLO REVOLUTION™ 4008 SERIES PUMP

RV FRESH WATER PUMP – PRODUCT TECHNICAL DATA SHEET

OEM: 4008-101-A65
 AFTERMARKET: 4008-101-E65



APPLICATION:

Multi-fixture RV fresh water pump installation.
 This pump may be used for general fresh water transfer

PUMP DESIGN:

Type: 4 Chamber Diaphragm pump
 Check Valve: (1-way operation) Prevents Reverse Flow
 Ports: 1/2" -14 NPSM-Male
 Liquid: 130°F [54°C] Max
 Dry-Prime: 6 feet [1.82 M]
 Run Dry: Yes
 Inlet Pressure: 30 PSI Max. [2.06 Bar]

ELECTRICAL:

Motor: 12V DC Permanent Magnet, Intermittent Duty
 Protection: Thermal Overload, Automatic Restart
 Leads: 16 AWG, 10" [25 cm] Red +, 13" [33 cm] Black
 Fuse: 10 Amp Recommended
 Control: Shut-Off 55 PSI [3.8 Bar] ± 2 PSI [0.13 Bar]
 Re-start 40 PSI [2.8 Bar] ± 2 PSI [0.13 Bar]
 Maximum By-Pass 62 PSI [4.2 Bar] ± 2 PSI [0.13 Bar]

MATERIALS OF CONSTRUCTION:

Housings: Polypro
 Valves/Seals: EPDM
 Diaphragm: Santoprene
 Hardware: Stainless Steel and Zinc Plated Steel

AGENCY APPROVALS:

CSA

SHIPPING INFORMATION:

Approx. Net Weight: 5 lbs. [2.3 Kg] ea.
 Carton Qty.: 12
 Approx. Carton Weight: 60 lbs. [27 Kg]
 Approx. Carton Size: 24"L X 18"W X 11"H [61cm x 46cm x 28cm]

REPAIR KITS

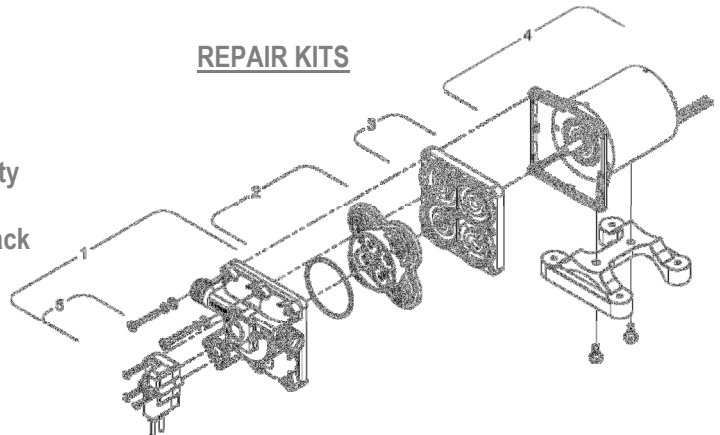

Number	Description	Part Number
*1,5	Upper Assy.	94-800-00
2	Valve Assy.	94-800-01
3	Drive Assy.	94-800-02
4	Motor	94-11-302-00
Not Shown	Check Valve	94-800-03
*1,2,3,5	Pump Head	94-800-04
*5	Pressure Sw.	94-800-05

*With preset switch and by-pass adjustment

RELATED DOCUMENTS:

Catalog: MS-030-138
 App Guide Sheet : MS-020-005
 Installation Manual: 911-1008
 Aftermarket Warranty: 911-1044

TYPICAL PERFORMANCE AT 12V

PRESSURE		FLOW		CURRENT
BAR	PSI	GPM	LPM	AMPS
0	0	3.0	11.3	2.2
0.7	10	2.2	8.3	3.3
1.4	20	1.8	6.8	4.3
2.1	30	1.5	5.7	5.1
2.8	40	1.2	4.5	6.0
3.4	50	0.5	1.9	6.8
4.1	60	0	0	6.6

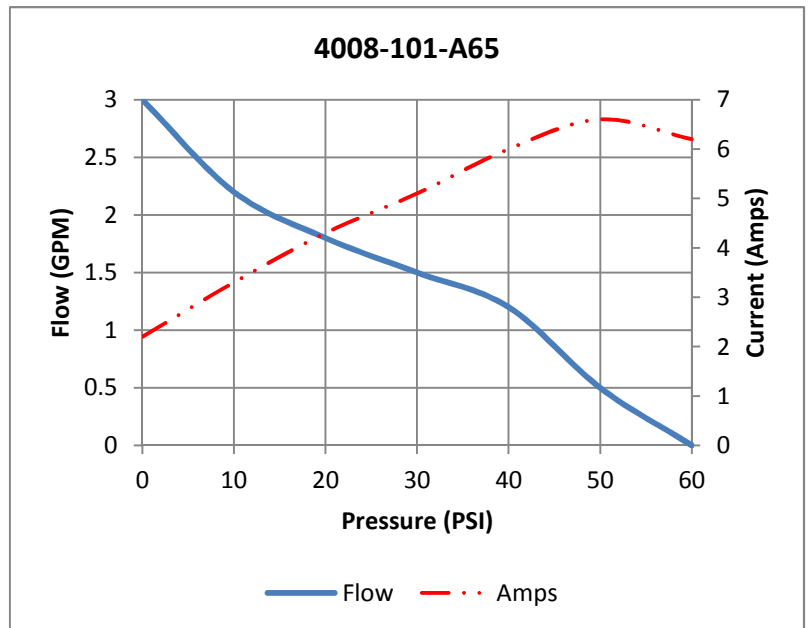

DIMENSIONS [mm]

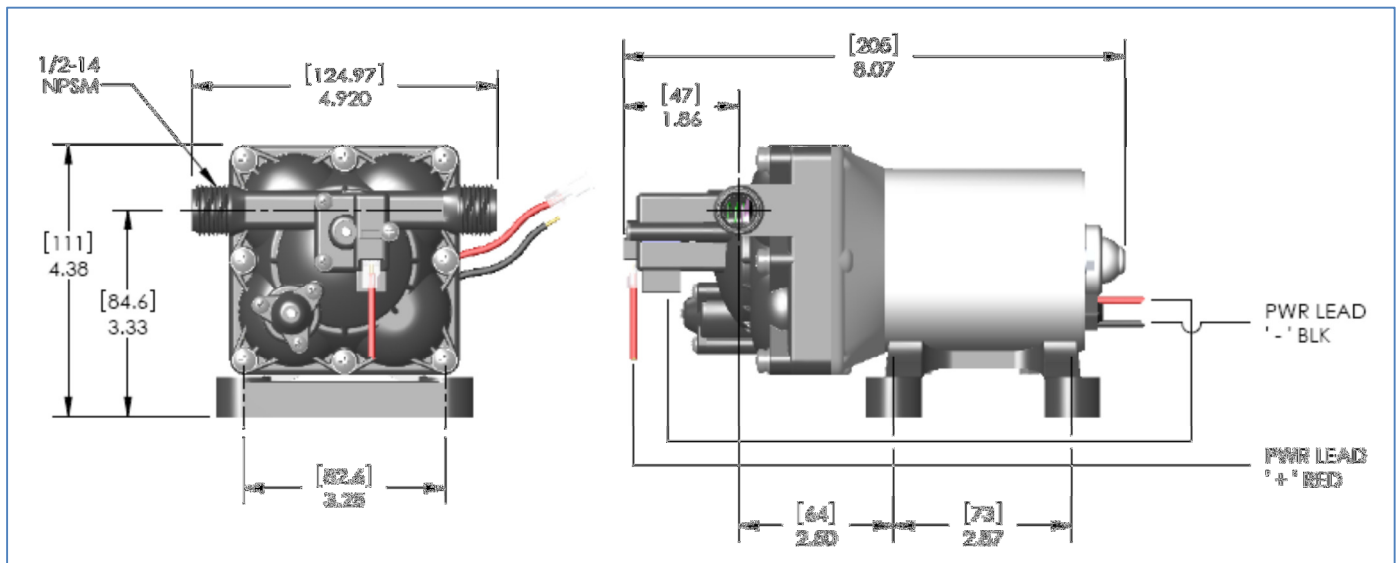

WATER PURIFICATION

3545 Harbor Gateway South, Suite 103, Costa Mesa, CA 92626, (800) 854-3218 www.SHURFLO.com

All Pentair trademarks and logos are owned by Pentair, Inc. All other brand or product names are trademarks or registered marks of their respective owners. Because we are continuously improving our products and services, Pentair reserves the right to change specifications without prior notice. Pentair is an equal opportunity employer.