

SIMRAD

IS42

Operator Manual

ENGLISH



Preface

Disclaimer

As Navico is continuously improving this product, we retain the right to make changes to the product at any time which may not be reflected in this version of the manual. Please contact your nearest distributor if you require any further assistance.

It is the owner's sole responsibility to install and use the equipment in a manner that will not cause accidents, personal injury or property damage. The user of this product is solely responsible for observing safe boating practices.

NAVICO HOLDING AS AND ITS SUBSIDIARIES, BRANCHES AND AFFILIATES DISCLAIM ALL LIABILITY FOR ANY USE OF THIS PRODUCT IN A WAY THAT MAY CAUSE ACCIDENTS, DAMAGE OR THAT MAY VIOLATE THE LAW.

Governing Language: This statement, any instruction manuals, user guides and other information relating to the product (Documentation) may be translated to, or has been translated from, another language (Translation). In the event of any conflict between any Translation of the Documentation, the English language version of the Documentation will be the official version of the Documentation.

This manual represents the product as at the time of printing. Navico Holding AS and its subsidiaries, branches and affiliates reserve the right to make changes to specifications without notice.

Trademarks

Simrad® is used by license from Kongsberg.

NMEA® and NMEA 2000® are registered trademarks of the National Marine Electronics Association.

Copyright

Copyright © 2016 Navico Holding AS.

Warranty

The warranty card is supplied as a separate document.

In case of any queries, refer to the brand website of your display or system: www.simrad-yachting.com.

Compliance statements

This equipment complies with:

- CE under EMC directive 2014/30/EU
- The requirements of level 2 devices of the Radio communications (Electromagnetic Compatibility) standard 2008

The relevant Declaration of conformity is available in the product's section at the following website: www.simrad-yachting.com.

About this manual

This manual is a reference guide for operating the IS42. It assumes that all equipment is installed and configured, and that the system is ready to use.

The manual assumes that the user has basic knowledge of navigation, nautical terminology and practices.

Important text that requires special attention from the reader is emphasized as follows:

→ **Note:** Used to draw the reader's attention to a comment or some important information.

⚠ **Warning:** Used when it is necessary to warn personnel that they should proceed carefully to prevent risk of injury and/or damage to equipment/personnel.

Manual version

This manual is written for software version 1.0. The manual is continually updated to match new software releases. The latest available manual version can be downloaded from www.simrad-yachting.com.

Contents

7 Introduction

- 7 Manuals
- 8 Front panel and keys

9 Basic operation

- 9 Turning the unit on and off
- 9 Operating the menu system
- 10 Display setup
- 11 Display mode
- 12 Selecting a data page
- 13 Man Over Board (MOB)

14 Pages

- 14 Enabling/disabling a page
- 14 Automatic scrolling pages
- 15 Predefined pages and template pages
- 22 Configuring data pages
- 23 Missing or faulty data

24 Trip log

25 AIS

- 25 The AIS page
- 25 AIS target symbols
- 26 Selecting a target
- 26 AIS page display options
- 27 Displaying target information
- 27 AIS messages
- 28 AIS SART
- 28 Vessel alarms
- 30 AIS settings

32 Autopilot

- 32 Safe operation with the autopilot
- 33 Autopilot controller
- 34 The autopilot page
- 34 Autopilot modes
- 41 Using the autopilot in an EVC system

41	Autopilot alarms
41	Autopilot settings
48	Alarms
48	Alarm indication
48	Acknowledging the alarms
49	Enabling the alarm system and the alarm siren
49	Alarm history
50	Alarm limits on analog pages
51	Software setup
51	Fuel
52	Remote displays
53	Calibration
58	Damping
58	System settings
65	Maintenance
65	Preventive maintenance
65	Cleaning the display unit
65	Checking the connectors
65	Software update
68	Menu flow chart
68	Page menus
68	Settings menu
71	Technical specification
72	Dimensional drawing
73	Terms and abbreviations
75	Supported data
75	NMEA 2000 PGN (transmit)
75	NMEA 2000 PGN (receive)

1

Introduction

The IS42 is a networked multifunction instrument. The display shows data measured by sensors and other equipment connected to the system.

The unit calculates speed, wind, trip distance and time, average speed, set and drift.

If a compatible autopilot computer is connected to the network, the IS42 will also display autopilot status.

Manuals

The following documentation is available for the IS42 system:

- IS42 Operator manual 988-11199-00n) - this manual
 - IS42 Quick guide (988-11204-00n)
 - OP12 Autopilot controller User guide (988-11231-00n)
 - AP44/IS42/Triton² Installation guide (988-11229-00n)
 - AP44/IS42/Triton² Mounting template (988-11230-00n)
 - OP12/Triton² Autopilot controller Mounting template (988-11231-00n)
 - NAC-2/NAC-3 Autopilot computer Commissioning manual (988-11233-00n)
 - AC12N/AC42N Installation manual (988-10276-00n)
- **Note:** The last digit in the part numbers is the document's revision code. The latest version of all documents can be downloaded from the product website on www.simrad-yachting.com.

Front panel and keys

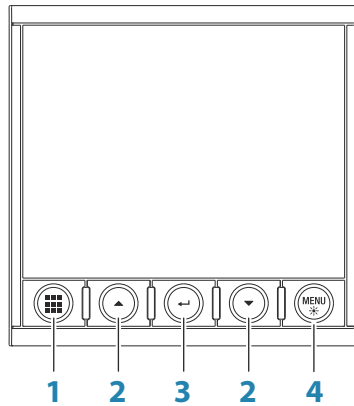

1 Pages key

With no menu active:

- Press to scroll through the enabled data pages
- Press and hold to display a list of enabled pages from where you can select directly the page to display

Menu and dialog operation: Press to return to previous menu level or to exit a dialog.

2 Arrow keys

Press to move up and down in menus and dialogs.
Press to adjust a value.

3 Enter key

Press to select a menu option and to enter the next menu level.

Press to activate/deactivate a menu/dialog option.

4 MENU/Backlight key

Press once to display the page menu.

Double-press to display the Settings menu.

Press and hold to display the Display setup dialog from where you can adjust the display backlight.

2

Basic operation

Turning the unit on and off

The unit has no power key, and it will be running as long as power is connected to the NMEA 2000 network backbone.

First time startup

When the unit is started for the first time and after a factory reset, the unit displays a setup wizard. Respond to the setup wizard prompts to select some fundamental setup options. These settings can later be changed and further configuration made as described in "Software setup" on page 51.

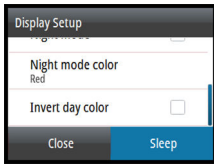

Sleep mode

In Sleep mode, the backlight for screen and keys are turned off to save power. The system continues to run in the background.

You select Sleep mode from the Display setup dialog, activated by pressing and holding the **MENU** key. Switch from Sleep mode to normal operation by a short press on the **MENU** key.

Operating the menu system

All functions and settings in the unit are available from the menu system, activated by pressing the **MENU** key from any page.

Not all pages have a page specific menu, but all page menus give access to the Settings menu.

You can also access the Settings menu by double-pressing the **MENU** key.

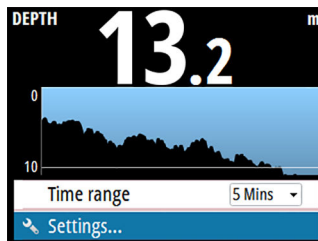

Page menu

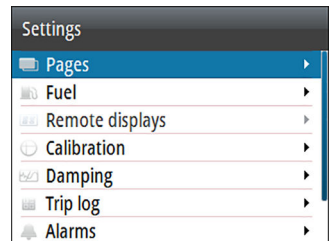

Settings menu

- Use the arrow keys to move up and down in the menus and in the dialogs
- Confirm a selection by pressing the Enter key
- Return to previous menu level by pressing the Pages key

Edit a numeric value

1. Use the arrow keys to select the entry field
2. Press the Enter key to turn the field into edit mode
 - The left digit starts flashing
3. Use the arrow keys to set the value for the flashing digit
4. Press the Enter key to move focus to the next digit
5. Repeat step 3 and 4 until all digits are set
6. Press the Enter key to leave edit mode for the selected field
7. Use the arrow keys to select the Cancel or Save buttons, then press the Enter key to confirm your selection and to close the dialog

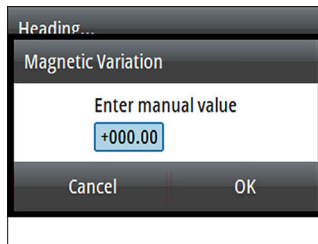

Selected field

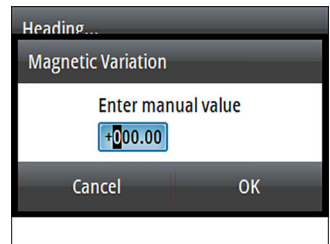

Field in edit mode

→ **Note:** You can at any time press the Pages key to leave a dialog without saving the entries.

Display setup

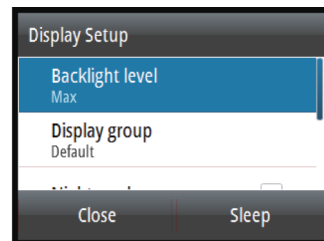
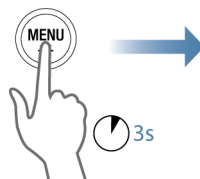

The display setup can be adjusted at any time from the Display setup dialog, activated by pressing and holding the **MENU** key.

The following options are available:

- Backlight level: Adjusts the backlight level from Min (10%) to Max (100%) in 10% increments
 - When the Backlight level field is active, subsequent presses on the **MENU** key adjusts backlight level in decrements of 30%
 - Display group: Defines which network group the unit belongs to
 - Night mode: Activates/deactivates the night mode color palette
 - Night mode color: Sets the night mode color palette
 - Invert day color: Changes the background color for the pages from default black to white
 - Sleep: Turns the backlight for screen and keys off to save power
- **Note:** All changes made to the display setup will apply to all units belonging to the same display group. For more information about network groups, refer to "*Network groups*" on page 61.

Display mode

The IS42 unit can be set up as an instrument only, as an autopilot display only, or as a combination of those two display modes.

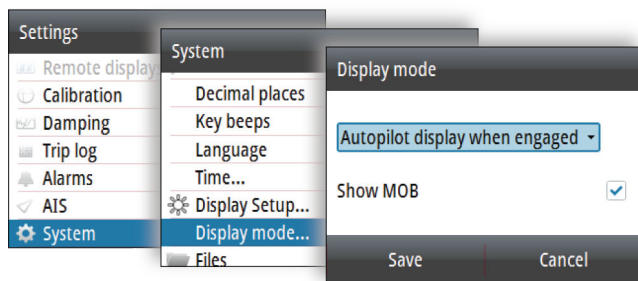

- Instrument display only: Displays active data pages. The Autopilot page can be one of these data pages
- Autopilot display only: Displays only the autopilot page

- Autopilot display when engaged: Switches automatically to the Autopilot page when the autopilot is switched to an automatic mode. When the autopilot is switched to Standby mode the display switches back to the previous page. This behaviour does not require that an Autopilot page is selected as one of the 8 enabled data pages

The Display mode dialog has the following additional options:

- Show MOB: Switches automatically to the MOB page if a Man Over Board event is triggered from another system on the network. Refer to "*Man Over Board (MOB)*" on page 13

Selecting a data page

The IS42 includes 14 predefined data pages, but only 8 of these can be enabled.

For detailed information about pages, refer to "*Pages*" on page 14.

Two options are available for selecting an enabled page:

- Directly selecting a page
- Scrolling pages

For automatic page scrolling, refer to "*Automatic scrolling pages*" on page 14.

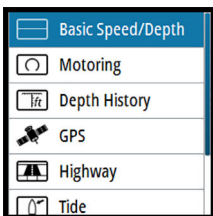

Directly selecting a page

Press and hold the Pages key to display a list of enabled pages, then:

- use the arrow keys to select the page you want to display
- confirm your selection by pressing the Enter key

If you don't confirm your selection the menu will timeout and the highlighted page will be displayed after 3 seconds.

Scrolling through enabled data pages

Press the Pages key to scroll through the enabled data pages.

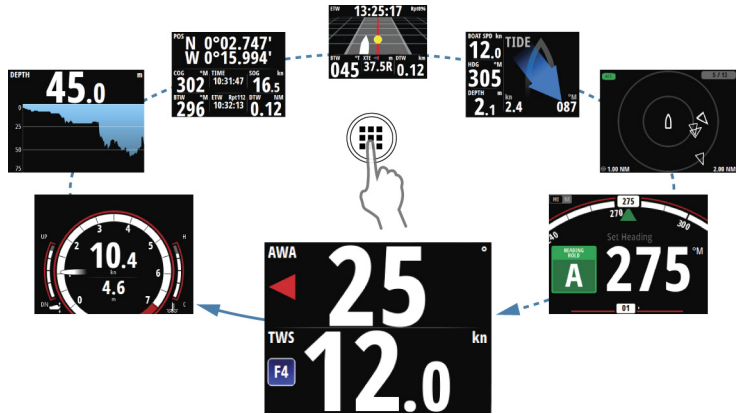

Man Over Board (MOB)

→ **Note:** MOB and AIS-SART will only work with a Simrad Multifunction Display (MFD) on the network.

If a Man Over Board event is triggered from another system on the network, the instrument automatically switches to the MOB page. This function can be enabled/disabled from the Display setup dialog. Refer to *"Display mode"* on page 11.

The MOB page shows the position, the range and the bearing of the MOB at the position the MOB function was activated. If the man over board event is activated via an AIS-SART, the MOB position is updated via the AIS-SART signal.

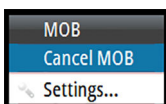
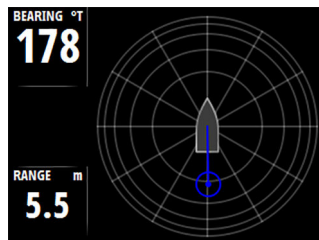

The system continues to display navigational information towards the MOB waypoint until you cancel the navigation from the menu.

3

Pages

The IS42 includes 14 predefined data pages.

In addition to these pages there are 13 template pages that can be used for creating user defined pages.

You can have up to 8 pages enabled in the unit. These can be any combination of predefined pages and user defined pages.

Enabling/disabling a page

To make a page available via the Page key you need to ensure it has been selected as one of the eight enabled pages.

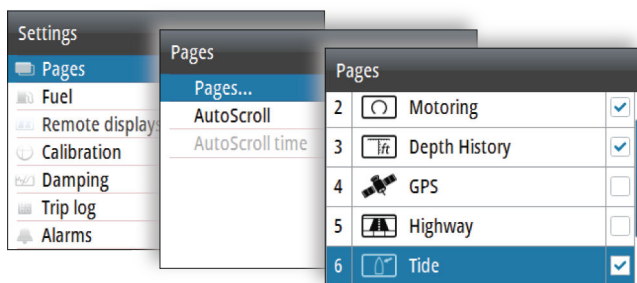







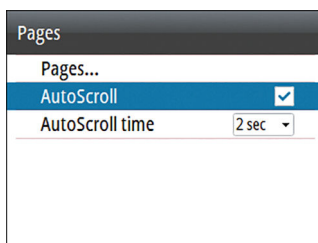



















Automatic scrolling pages

You can select to let the system automatically scroll through all enabled pages at a defined time interval.

You set the time interval and start the automatic scrolling function from the Pages menu.



Predefined pages and template pages

Pre-defined pages		Template pages	
	Autopilot status		Full screen
	Highway		2x1 Grid
	Tide		2x2 Grid
	Weather		2x2 Grid Offset
	Depth history		3x3 Grid
	Basic Speed/Depth		1 + 3 Digital - bottom
	Basic Wind Angle/ Speed		1 + 6 Digital
	GPS		1 + 3 Digital - side
	Composite Wind		1 + 4 Digital
	AIS		Single analog
	Motoring		Analog + 3
	Steering		2x2 Digital (Engine)
	Single Time Plot		Composite Wind + 3
	Dual Time Plot		

Autopilot status page

Autopilot status. Refer to "Autopilot" on page 32.

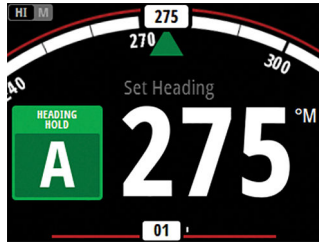

Highway page

Navigation information, including a 3D view of the boat position on the track.

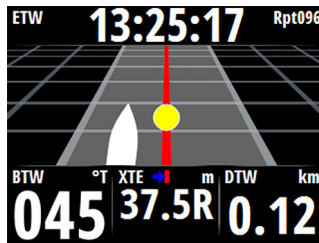

Tide page

Tidal information shown relative to the yacht's bow.

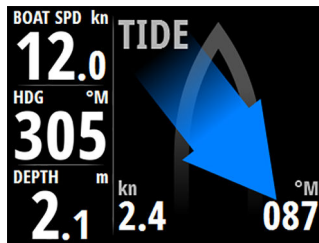

Weather page

Weather data shown graphically along with environmental data for easy visualization.

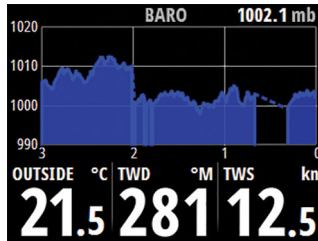

The barometer time period can be set to show from 3 hours until 48 hours history. You change the period from the menu or by using the arrow keys.

Depth history page

Current depth and histogram of recorded depth data.

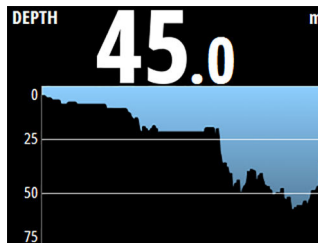

The Depth histogram time period can be set to show 5, 10, 30 or 60 minutes history.

You change the period from the menu or by using the arrow keys.

Speed/Depth page

Basic speed and depth. Speed field includes an acceleration bargraph.

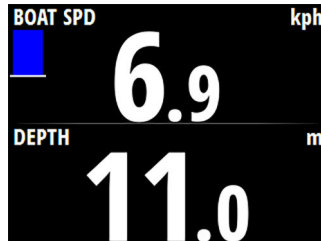

Wind Angle speed page

Apparent angle and true wind speed.

The wind angle indicator (1) is red for port and green for starboard tack. The true wind speed field includes a Beaufort scale indicator (2).

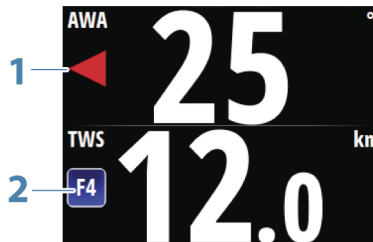

GPS page

GPS and navigation information. If not navigating the navigation fields show dashes.

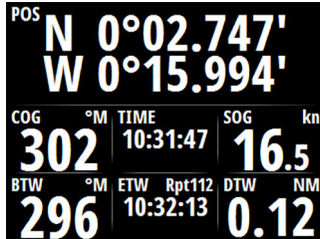

Composite Wind

Easy visualization of wind information.

Apparent wind angle indicator (1) and true wind angle indicator (2).

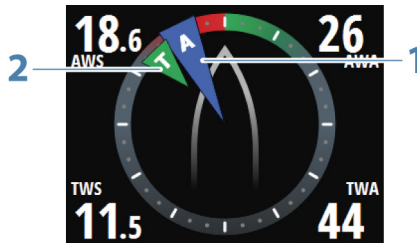

AIS page

Showing AIS targets within selected range. Refer to "AIS" on page 25.

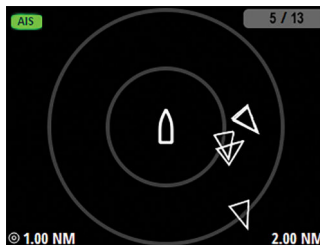

Motoring

Engine information, including analog dial for RPM (**1**), two dynamic data fields (**2**), and bars for engine trim (**3**) and engine temperature (**4**).

The dynamic data fields display information in the following priority:

- Priority 1
 - SOG
 - Speed through water
 - Speed (pitot)
- Priority 2
 - Depth
- Priority 3
 - Vessel fuel economy GPS
 - Vessel fuel economy water
- Priority 4
 - Vessel fuel rate

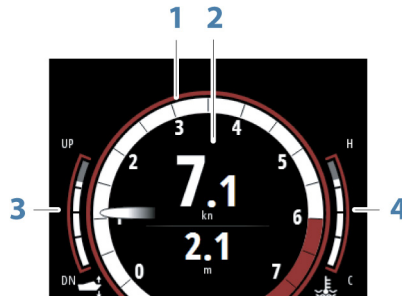

The needle color indicates the engine's position: white for center, red for port and green for starboard.

The motoring page can be set up to show one or two engines. Refer to "*Engine setup*" on page 63.



One engine



Two engines

When two gauges are selected, the data displayed in the dynamic fields are not repeated for the second gauge.

Steering

Navigational data, including an easy visualization of compass heading.

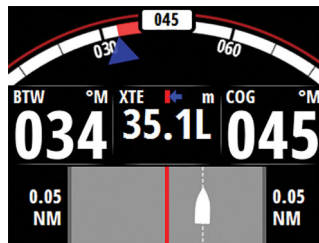

Single time plot

Easy visualization showing current and historical data plotted over a specified time scale.

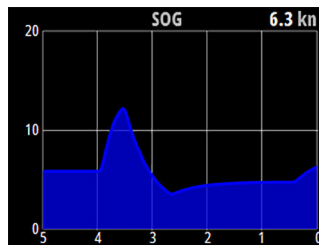

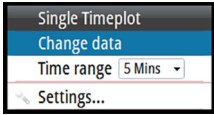

You can change data and time period from the menu.
The time period can also be adjusted by using the arrow keys.

Dual time plot

Easy visualization showing current and historical data plotted over a specified time scale.

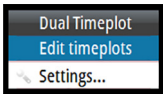
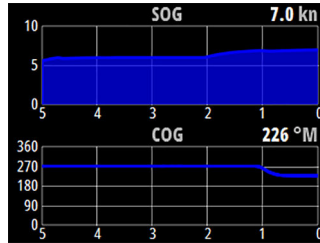

You can change data and time period for each of the time plots from the menu.

Configuring data pages

Replacing a page

Any enabled page can be replaced with one of the other predefined pages, or by a template page if you want to create a custom page.

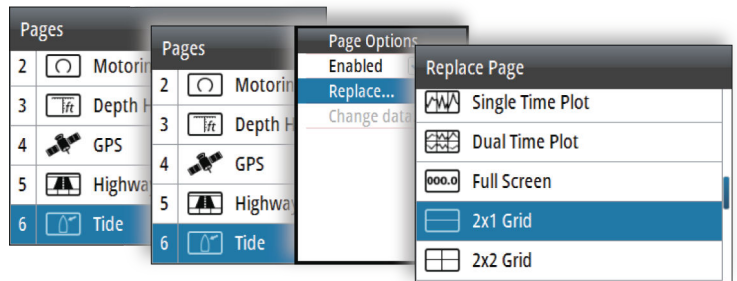

Creating/editing a custom page

A custom page is created in a two steps process:

- Replacing one of the active pages with a template page (ref above)
 - Selecting data for the template page's field(s)
- **Note:** If the template page has multiple data fields you use the arrow keys to select active field.

You can later change the data for any fields in a custom page.

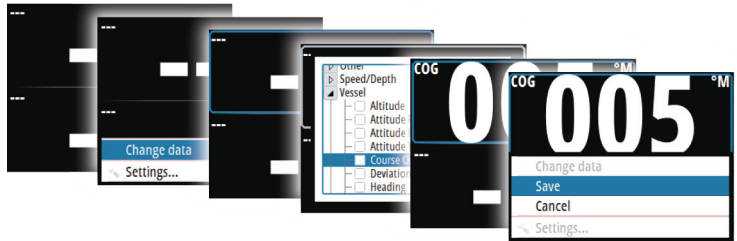

Changing the range scale on analog pages

You can change the range scale for some full screen analog pages by pressing the arrow keys.

- **Note:** If the actual recorded data is greater than the selected analog scale, the analog needle will remain at the highest point on the scale. The digital window in the center of the display will show the actual value.

Missing or faulty data

If a data type is missing or if the data is out of scale, there will be no data reading on the display.

The example shows the basic Depth/Speed page with missing speed information.

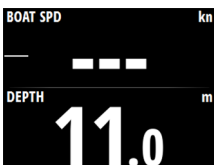

4

Trip log

The Trip log is available from the Settings menu.

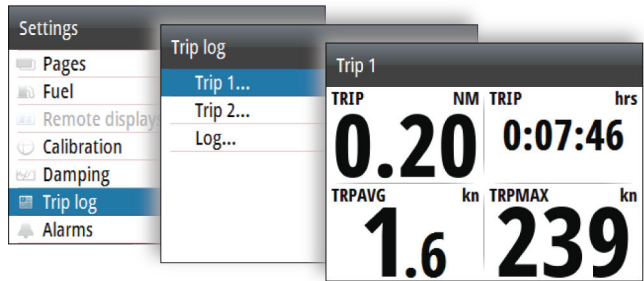

The Trip log is a temporary page, and you cannot configure this view as one of the user defined pages.

The Trip log remains on the screen until you press the Pages key.

There are three log options available:

- Trip 1: records distance traveled through the water (Log input)
- Trip 2: records distance traveled via GPS input
- Log: shows total distance run from system installation or from a system restore

→ **Note:** Trip 1 requires correctly calibrated boat speed for accurate trip records.

Trip 2 requires a compatible GPS connected to the network.

You start, stop and reset the active Trip log from the menu, activated by pressing the **MENU** key.



5

AIS

If a compatible AIS system or an NMEA 2000 VHF that can do AIS (Automatic Identification System) is connected to the network, then any targets detected by these devices can be displayed on the AIS page. You can also see messages and position from SARTs and AtoNs within the defined range.

The AIS page

The AIS page shows:

- own vessel in the center of the page
- AIS targets within set range
- AIS mode **(A)**

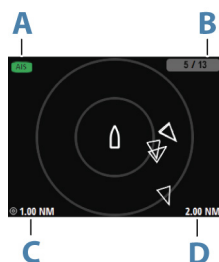

AIS

Transmitting mode





Silent or receive only mode

- number of displayed icons versus total number of targets **(B)**
- distance between range rings **(C)**
- selected range **(D)**.

AIS target symbols

The system uses the AIS target symbols shown below:

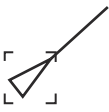
	Sleeping AIS target (not moving or at anchor).
	Moving and safe AIS target with course extension line.
	Dangerous AIS target, illustrated with bold line. A target is defined as dangerous based on the CPA and TCPA settings. Refer to <i>"Defining dangerous vessels"</i> on page 30.
	Lost AIS target. When no signals have been received within a time limit, a target is defined as lost. The target symbol represents the last valid position of the target before the reception of data was lost.

	<p>Selected AIS target, activated by selecting a target symbol. The target returns to the default target symbol when the cursor is removed from the symbol.</p>
	<p>AIS SART (AIS Search And Rescue Transmitter).</p>

Selecting a target

You use the arrow keys to select individual AIS targets on the AIS page. When selected the target symbol change to a selected AIS target symbol.

AIS page display options

The following options are available for displaying the AIS targets:

Range

Icon Filters...

Extension lines...

Target List

Range

Defines the display range on the AIS page. Selected range is indicated in the lower right corner of the AIS page.

Icon filters

By default, all targets within the selected range are shown on the AIS page. You can select to hide safe AIS vessels, and to not show targets based on vessel speed.

Extension lines

Defines the length of course over ground and heading extension lines for your own vessel and for other vessels.

The length of the extension lines is set to indicate the distance the vessel will move in the selected time period.

Your own vessel heading information is read from the active heading sensor, and COG information is received from the active GPS. For other vessels COG data is included in the message received from the AIS system.

Displaying target information

Displaying information for a single target

When a target is selected, you press the Enter key to display detailed information about the selected target.

Target list

The Target list displays basic information for all received AIS targets.

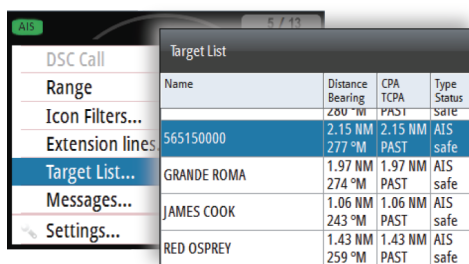

The screenshot shows the AIS interface with a menu on the left and a 'Target List' window on the right. The menu includes options like 'DSC Call', 'Range', 'Icon Filters...', 'Extension lines', 'Target List...', 'Messages...', and 'Settings...'. The 'Target List' window displays a table with the following data:

Name	Distance	Bearing	CPA	TCPA	Type	Status
565150000	2.15 NM	277 °M	2.15 NM	PAST	AIS	safe
GRANDE ROMA	1.97 NM	274 °M	1.97 NM	PAST	AIS	safe
JAMES COOK	1.06 NM	243 °M	1.06 NM	PAST	AIS	safe
RED OSPREY	1.43 NM	259 °M	1.43 NM	PAST	AIS	safe

By pressing the **MENU** key you can sort the target list by the different information. You can also select to include all targets or only dangerous targets in the list.

AIS messages

Receiving a message

A message received from an AIS vessel will immediately be displayed on any page if the Vessel message is turned on in the Alarm settings dialog. Refer to "*Vessel alarms*" on page 28.

List of all AIS messages

All received messages are listed in the Message listing, activated by pressing the **MENU** key when the AIS page is displayed.

Select a message and press the **MENU** key to display the original message.

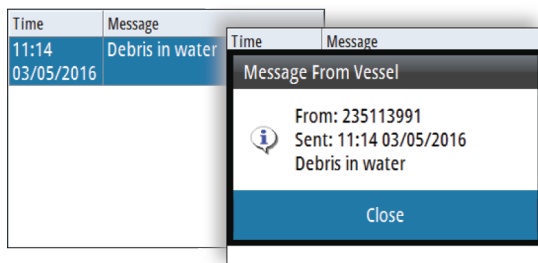

Calling an AIS vessel

If the system includes a VHF radio supporting DSC (Digital Select Calling) calls over NMEA 2000, you can initiate a DSC call to other vessels from the IS42.

From the Call dialog you can change channel or cancel the call. The Call dialog is closed when the connection is established.

AIS SART

When an AIS SART (Search and Rescue beacon) is activated, it starts transmitting its position and identification data. This data is received by your AIS device.

If your AIS receiver is not compliant with AIS SART, it interprets the received AIS SART data as a signal from a standard AIS transmitter. An icon is positioned on the AIS page, but this icon is an AIS vessel icon. If your AIS receiver is compliant with AIS SART, the following takes place when AIS SART data is received:

- An AIS SART icon is located on the page in the position received from the AIS SART
- An alarm message is displayed if you have enabled the siren, the alarm message is followed by an audible alarm.

→ **Note:** The icon is green if the received AIS SART data is a test and not an active message.

Vessel alarms

You can define several alarms to alert you if a target shows up within predefined range limits, or if a previously identified target is lost.

The alarms are activated from the Alarm Settings dialog.

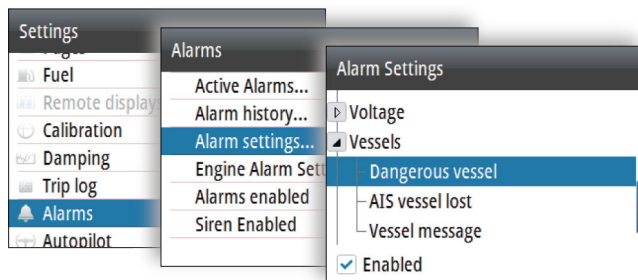

For more information about alarms, refer to "Alarms" on page 48.

Dangerous vessel

Controls whether an alarm will be activated when a vessel comes closer than the distance for CPA within the time limit for TCPA. Refer to "Defining dangerous vessels" on page 30.

AIS vessel lost

Sets the range for lost vessels. If a vessel is lost within the set range, an alarm occurs.

→ **Note:** The check box controls whether the alarm pop-up box is displayed and if the siren goes on. The CPA and TCPA define when a vessel is dangerous regardless of the enabled or disabled state.

Vessel message

Controls whether an alarm will be activated when a message is received from an AIS target.

AIS settings

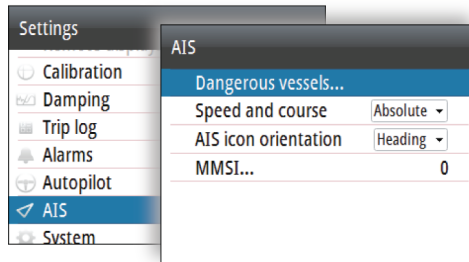

Defining dangerous vessels

You can define an invisible guard zone around your vessel. When a target comes within the set limits, the symbol changes to the Dangerous target symbol. An alarm is triggered if activated in the Alarm settings panel.

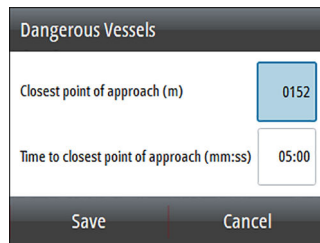

Speed and course indication

The extension line can be used to indicate speed and course for targets, either as absolute (true) motion or relative to your vessel.

AIS icon orientation

Sets the orientation of the AIS icon, either based on heading or COG information.

Your vessel's MMSI number

Used for entering your own MMSI (Maritime Mobile Service Identity) number into the system. You need to have this number entered to receive addressed messages from AIS and DSC vessels.

6

Autopilot

If a compatible autopilot computer is connected to the system, autopilot functionality is available in the system.

The system does not allow for more than one autopilot computer on the network.

The display unit automatically detects the autopilot computer available on the network and presents settings, configuration and user options for the connected computer.

For details about installing and configuring an autopilot computer, refer to the separate manuals that come with the autopilot computer.

Safe operation with the autopilot

⚠ Warning: An autopilot is a useful navigational aid, but **DOES NOT** replace a human navigator.

⚠ Warning: Ensure the autopilot has been installed correctly, commissioned and calibrated before use.

→ **Note:** You can disengage the autopilot at any time by pressing the **STBY** key on the OP12 Autopilot controller.

Do not use automatic steering when:

- In heavy traffic areas or in narrow waters
- In poor visibility or extreme sea conditions
- When in areas where use of an autopilot is prohibited by law

When using an autopilot:

- Do not leave the helm unattended
- Do not place any magnetic material or equipment near the heading sensor used by the autopilot system
- Verify at regular intervals the course and position of the vessel
- Always switch to Standby mode and reduce speed in due time to avoid hazardous situations

Autopilot controller

The autopilot is controlled by the OP12 Autopilot controller.

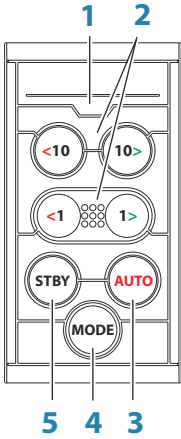

1 LED - Mode and alarm indicator

2 Port and starboard keys

In Standby mode: press to activate Non Follow Up mode (NFU).

In AUTO mode:

- Press a key to change set heading 1° or 10° to port or starboard
- For boat type set to SAIL: Press and hold both port keys or both starboard keys to start a tack/gybe

In NoDrift mode:

- Press a key to change set heading 1° or 10° to port or starboard

In Wind mode:

- Press to change set wind angle 1° or 10° to port or starboard
- Press both 1° keys to start a tack/gybe

3 AUTO key

Press to activate AUTO mode.

4 MODE key

→ **Note:** Only used when the autopilot is in AUTO or NoDrift mode.

Press once to select mode:

- For boat type set to SAIL: activates Wind mode (**A**)
- For other boat type settings: activates NoDrift mode (**B**)

Press and hold to activate NAV mode (**C**)

5 STBY key

Press to activate Standby mode.

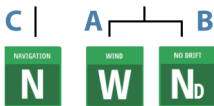
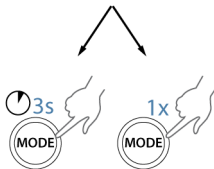
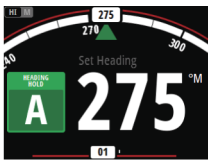

Mode and alarm indication

The LED in the Autopilot controller indicates active mode and alarm by the flashing:

- AUTO mode: solid light
- Wind mode: flashing (80% on, 20% off)
- NAV mode; flashing (40% on, 60% off)
- Alarm on the network: rapid flashing

The LED is green in Day mode and red in Night mode

→ **Note:** There is no LED indication for NoDrift and Non-Follow modes.

The autopilot page

The content of the autopilot page varies with active mode. All modes include:

- Response (AC12N/AC42N/SG05) / Profile (NAC-2/NAC-3) mode **(A)**
- Heading indicator, analog and digital **(B)**
- Autopilot mode indication **(C)**
- Rudder indicator, analog and digital **(D)**

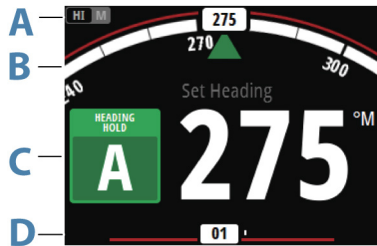

For more information, refer to the separate mode descriptions and to the *"Terms and abbreviations"* on page 73.

Autopilot modes

The autopilot has several steering modes. The number of modes and features within the mode depend on the autopilot computer, the boat type and available inputs, as explained in the description of the following steering modes.

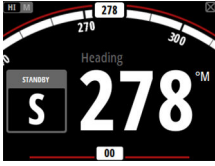

Standby mode

Standby mode is used when you steer the boat at the helm.

- Switch to Standby mode by pressing the **STBY** key.
- **Note:** If you press one of the port or starboard keys while in Standby mode, the autopilot will switch to Non-Follow Up mode.

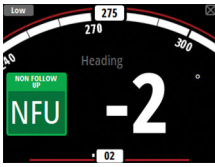

Non-Follow Up (NFU) mode

In NFU mode you can use the port and starboard keys on the controller to operate the rudder. The rudder will move as long as the key is pressed.

- Switch to NFU mode by pressing one of the port or starboard keys when the autopilot is in Standby mode.

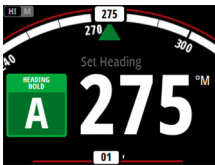

AUTO mode (Heading hold)

In AUTO mode the autopilot issues rudder commands required to steer the vessel automatically on a set heading. In this mode the autopilot does not compensate for any drifting caused by current and/or wind (**A**).

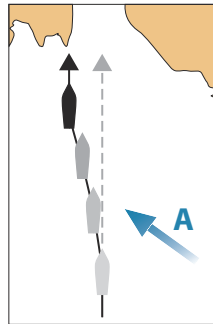

- Switch to AUTO mode by pressing the **AUTO** key. When the mode is activated, the autopilot selects the current boat heading as the set heading.

Changing set heading in AUTO mode

You adjust the set heading by using the port or starboard keys.

An immediate heading change takes place. The new heading is maintained until a new heading is set.

Tacking and Gybing in AUTO mode

Tacking and Gybing in AUTO mode uses the heading as reference. The tacking/gybing operation changes the set heading to port or starboard with a fixed angle.

The tacking parameters are set in the Setup/Sailing parameters: The **Tack angle** defines the tacking angle, while the **Tack time** defines the rate of turn during the tack/gybe. Refer to "*Autopilot settings*" on page 41:

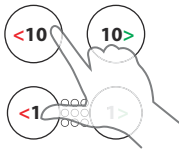

- Initiate the Tack or Gybe function to port or starboard by pressing and holding both port keys or both starboard keys on the autopilot controller.
 - The turn is started immediately to the direction selected by the keys.

Wind mode

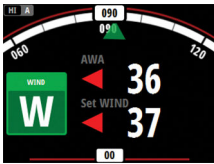

- **Note:** Wind mode is only available when the boat type is set to SAIL. It is not possible to activate wind mode if wind information is missing.

When wind mode is engaged, the autopilot captures the current wind angle as steering reference, and adjusts the heading of the boat to maintain this wind angle.

Prior to entering wind mode the autopilot system must be operating in AUTO mode and with valid input from the wind transducer.

- Switch to Wind mode by pressing the **MODE** key when the autopilot is in AUTO mode.

The autopilot will now keep the boat on the set wind angle until a new mode is selected or a new wind angle is set.

⚠ Warning: In wind mode the autopilot steers to the apparent or true wind angle and not to a compass heading. Any wind shift could result in the vessel steering on an undesired course.

Tacking and Gybing in Wind mode

Tacking and Gybing in Wind mode can be performed when sailing with apparent or true wind as the reference. In either case the true wind angle must be less than 90 degrees (tacking) and more than 120° (gybing).

The tacking/gybing operation will mirror the set wind angle on the opposite tack.

The rate of turn during the tack/gybe is set by the **Tack time** in the Setup/Sailing menu. Refer to "*Autopilot settings*" on page 41.

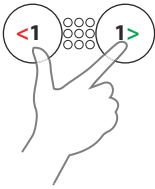

- Initiate the Tack or Gybe function by pressing both the port and the starboard 1° keys on the autopilot controller.
- Confirm the tack/gybe in the dialog by pressing the **AUTO** key on the autopilot controller or the Enter key on the IS42.

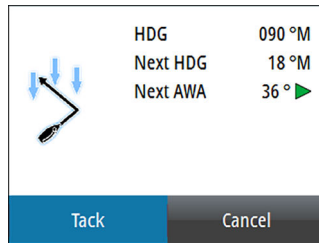

→ **Note:** The autopilot will temporarily add a 5 degree bear-away on the new tack to allow the boat to pick up speed. After a short period the wind angle will return to the set angle.

→ **Note:** If the Tack/Gybe is not confirmed the dialog will close after 10 seconds, and the requested tack/gybe will not be initiated.

NoDrift mode

→ **Note:** NoDrift mode is not available if the boat type is set to SAIL.

It is not possible to select NoDrift mode if position and heading information is missing.

In NoDrift mode the vessel is steered along a calculated track line, from present position and in a direction set by the user. If the vessel

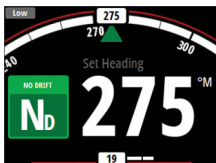

is drifting away from the track line due to current and/or wind (**A**), the vessel will follow the line with a crab angle.

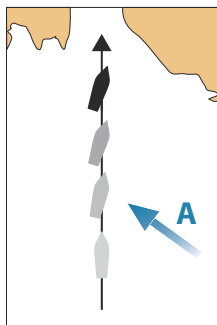

Prior to entering NoDrift mode the autopilot system must be operating in AUTO mode and with valid input from GPS and heading sensor.

- Switch to NoDrift mode by pressing the **MODE** key when the autopilot is in AUTO mode
 - The autopilot will draw an invisible track line based on current heading from the vessel's position

The autopilot will now use the position information to calculate the cross track distance, and automatically steer along the calculated track.

Changing set course in NoDrift mode

You adjust the set course by using the port or starboard keys.

An immediate course change takes place. The new course is maintained until a new course is set.

Dodging

→ **Note:** Only available for AC12N/AC42N autopilot computers.

If you need to avoid an obstacle when using NoDrift mode, you can set the autopilot to Standby mode and power steer or use the helm until the obstacle is passed.

If you return to NoDrift mode within 60 seconds you can select to continue on previous set bearing line.

If you do not respond, the dialog disappears and the autopilot goes to NoDrift mode with current heading as set bearing line.

Heading capture

When the vessel is turning in AUTO or NoDrift mode, an instant repress on the **AUTO** key activates the heading capture function. This will automatically cancel the turn, and the vessel will continue on the heading read from the compass the very moment you pressed the **AUTO** key.

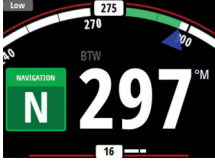

NAV mode

→ **Note:** NAV mode requires a compatible chartplotter connected to the network.

It is not possible to select NAV mode if heading information is missing, or if steering information is not received from the external chartplotter.

⚠ Warning: NAV mode should only be used in open waters. Navigation mode must not be used while sailing, as course changes may result in unexpected tacks or gybes!

In NAV mode the autopilot uses steering information from an external chartplotter to direct the vessel to one specific waypoint location, or through a series of waypoints.

In NAV mode, the autopilot's heading sensor is used as heading source for course keeping. Speed information is taken from SOG or from selected speed sensor. The steering information received from the external chartplotter alters the set course to direct the vessel to the destination waypoint.

To obtain satisfactory navigation steering, the autopilot system must have valid input from the chartplotter. Autosteering must be tested and determined satisfactory prior to entering NAV mode.

→ **Note:** If the chartplotter does not transmit a message with bearing to next waypoint, the autopilot will steer using Cross Track Error (XTE) only. In that case you must revert to AUTO mode at each waypoint and manually change set course to equal bearing to next waypoint and then select NAV mode again.

Prior to entering NAV mode the autopilot system should be operating in AUTO mode. The chartplotter must be navigating a route or towards a waypoint.

- Initiate NAV mode by pressing and holding the **MODE** key for 3 seconds when the autopilot is in AUTO mode.
- Confirm to switch to NAV mode in the dialog by pressing the **AUTO** key on the autopilot controller or the Enter key on the IS42.

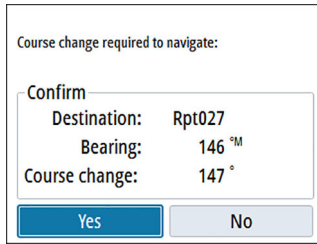

Turning in NAV mode

When your vessel reaches a waypoint, the autopilot will give an audible warning and display a dialog with the new course information.

There is a user defined limit for the allowed automatic course change to next waypoint in a route. If the course change is more than this set limit, you are prompted to verify that the upcoming course change is acceptable.

- If the required course change to the next waypoint is less than the course change limit, the autopilot will automatically change the course. The dialog will disappear after 8 seconds unless cleared by the Pages key.
- If the required course change to next waypoint is more than the set limit, you are prompted to verify that the upcoming course change is acceptable. If the turn is not accepted, the vessel will continue with the current set heading.

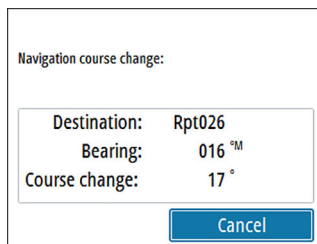

Course change less than set limit

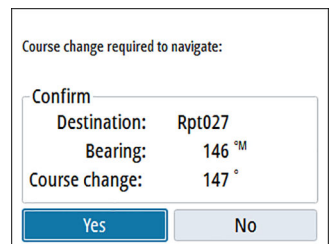

Course change larger than set limit

The course change limit setting depends on the autopilot computer:

- NAC-2/NAC-3: **Course chg confirm angle**, refer to "Steering (NAC-2/NAC-3)" on page 42

- AC12N/42N and SG05: **Navigation change limit**, refer to *"Automatic steering (AC12N/AC42N)"* on page 46

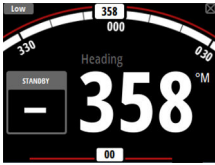

Using the autopilot in an EVC system

When the IS42 is connected to an EVC system via the SG05, you can take manual control of the steering regardless of the autopilot mode.

The mode indicator is replaced by a dash to indicate EVC override.

The system returns to IS42 control in Standby mode if no rudder command is given from the EVC system within a predefined period.

Autopilot alarms

You can define several alarms to alert you if the autopilot system or autopilot sensors are failing.

The alarms are activated from the Alarm Settings dialog.

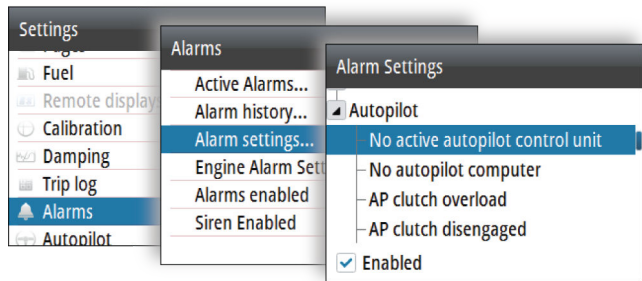

For more information about alarms, refer to *"Alarms"* on page 48.

Autopilot settings

The autopilot settings can be split between settings done by the user, and settings done during installation and commissioning of the autopilot system.

- User settings can be changed for various operational conditions or user preferences
- Installation settings are defined during commissioning of the autopilot system. No changes should later be done to these settings

Both user settings and installation settings depends on which autopilot computer that is connected to the system.

The following sections describe the settings that can be changed by the user. The settings are described per autopilot computer.

Installation settings are available in the documentation following the autopilot computers.

NAC-2/NAC-3 Autopilot computer

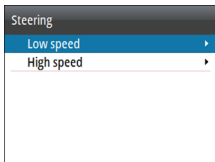
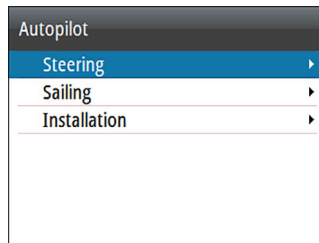

Steering (NAC-2/NAC-3)

This option allows for manually changing parameters that were set during the commissioning of the autopilot computer. For more details of the settings, refer to the separate documentation for the autopilot computer.

- Low speed / High speed
 - Turn rate: The rate the vessel is turning in degrees per minute
 - Rudder gain: Ratio between the heading error and the commanded angle
 - Counter rudder: Counteracts the effect of the vessel turn rate and inertia
 - Autotrim: When the vessel has a constant heading error due to external forces such as wind and current, the Autotrim function corrects for this by building up a constant rudder offset. The Autotrim value is reset every time the AUTO mode is entered or when a course change greater than approximately 20° is made. Auto trim is automatically disabled during a turn.
 - Init rudder: Defines how the system moves the rudder when switching from power steering to an automatic mode.
 - Center: Moves the rudder to zero position
 - Actual: Maintains the rudder offset

- Rudder limit: Determines the maximum rudder movement in degrees from midship position that the autopilot can command the rudder in the automatic modes. The Rudder limit setting is only active during autosteering on straight courses, NOT during course changes. Rudder limit does not affect Non-Follow-up steering.
- Off heading limit: Sets the limit for the off heading alarm. An alarm occurs when the actual heading deviates from the set heading more than the selected limit.
- Track response: Defines how fast the autopilot shall respond after having registered a cross track distance
- Track approach angle: Defines the angle used when the vessel is approaching a leg. This setting is used both when you start navigating and when you use track offset.
- Course change confirm angle: Defines the limits for course change to next waypoint in a route. If the course change is more than this set limit, you are prompted to verify that the upcoming course change is acceptable.

Sailing (NAC-2/NAC-3)

→ **Note:** Sailing parameters are only available when the boat type is set to Sail.

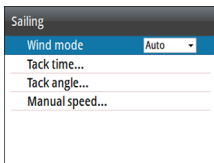

- Wind mode: Select what wind function the autopilot will use when in wind mode
 - Auto:
 - If TWA is $<70^\circ$: Wind mode will use AWA
 - If TWA is $\geq 70^\circ$: Wind mode will use TWA
 - Apparent
 - True
- Tack time: Controls the rate of turn (tack time) when performing a tack in wind mode.
- Tack angle: Controls the angle that the boat will tack to between 50° - 150° in AUTO mode
- Manual speed: If neither boat speed or SOG data is available and or deemed reliable a manual value for speed source can be entered and used by the autopilot to aid steering calculations

AC12N/AC42N Autopilot computer

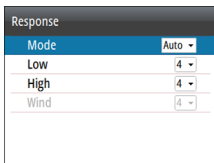
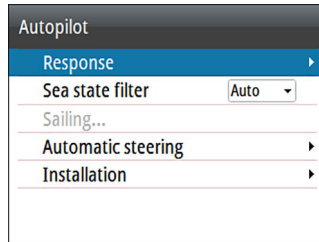

Response (AC12N/AC42N)

The AC12N/42N includes three different sets of steering modes; High (HI), Low (LO) and Wind. The mode can be automatically or manually selected.

The speed at which the autopilot automatically changes from LO to HI parameters (or opposite) is determined by the Transition speed setting, defined during the commissioning of the autopilot. Refer to the detailed description in the autopilot computer's documentation.

You can manually fine tune each of the three response modes. Level 4 is default with parameter values as set by the autotune function. If no autotune is made (not recommended) the level 4 values are the factory default values.

- A low response level reduces the rudder activity and provides a more "loose" steering
- A high response level increases the rudder activity and provides a more "tight" steering. A too high response level causes the boat to start lazy-s movements.

The Wind response is used on sailboats

- Increase the Wind value if the difference between the set wind angle and the actual wind angle is too big
- Decrease the Wind value if the actual wind angle is S-ing around the set wind angle, or if the rudder activity is too high



The performance mode is indicated in the top left corner of the autopilot page.

- HI-A: High response mode set automatically

- LO-A: Low response mode set automatically
- HI-M: High response mode set manually
- LO-M: Low response mode set manually

➔ **Note:** If no speed input is available the autopilot defaults to LO steering parameters when engaging an automatic mode. This is a safety feature to prevent oversteering

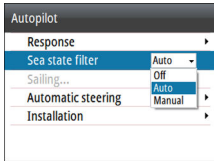

Sea state filter (AC12N/AC42N)

This filter is used to reduce rudder activity and autopilot sensitivity in rough weather.

- OFF: Seastate filter is disabled. This is the default setting.
- AUTO: Reduces rudder activity and autopilot sensitivity in rough weather by an adaptive process. The AUTO setting is recommended if you want to use the seastate filter.
- MANUAL: Linked to the steering response control settings described previously. It may be used to manually find the optimum combination of course keeping and low rudder activity in rough but steady sea conditions.

Sailing (AC12N/AC42N)

➔ **Note:** Sailing parameters are only available when the boat type is set to Sail.

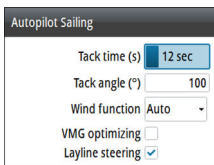

- Tack time: Controls the rate of turn (tack time) when performing a tack in wind mode.
- Tack angle: Controls the angle that the boat will tack to between 50° - 150° in AUTO mode
- Wind mode: Select what wind function the autopilot will use when in wind mode
 - Auto:
 - If AWA is $\leq 60^\circ$: Wind mode will use AWA
 - If AWA is $> 60^\circ$: Wind mode will use TWA
 - Apparent
 - True
- VMG optimizing: Optimize the VMG to wind. The function will be active for 5–10 minutes after a new wind angle has been set and only when beating.

- Layline steering: When enabled the Cross Track Error (XTE) from the navigator will keep the boat on the track line. If the XTE from the navigator exceeds 0.15 Nm, the autopilot will calculate the layline and track towards the waypoint.

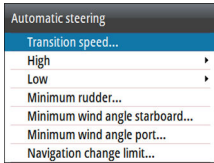

Automatic steering (AC12N/AC42N)

This option allows for manually changing parameters that were set during the commissioning of the autopilot computer. For more details of the settings, refer to the separate documentation for the autopilot computer.

- Transition speed: This is the speed at which the autopilot will automatically change the steering parameter set from HI to LO parameters, or vice versa. On power boats it is recommended to set the Transition speed to a speed that represents the speed where the hull begins to plane or the speed where you change from slow to cruising speed
On sailboats the Transition speed should be set to 3-4 knots to give the best response in a tack
- High/Low
 - Rudder gain: This is the ratio between the heading error and the commanded rudder angle. Low speed requires more rudder gain than high speed
 - Too little Rudder gain and the autopilot fails to keep a steady course
 - Too much Rudder gain gives unstable steering and reduces speed
 - Counter rudder: This parameter counteracts the effect of the vessel turn rate and inertia. The best way of checking the value of the Counter Rudder setting is when making turns.
 - Auto trim: When the vessel has a constant heading error due to external forces such as wind and current, the Auto trim function corrects for this by building up a constant rudder offset. The Auto trim value is reset every time the AUTO mode is entered or when a course change greater than approximately 20° is made. Auto trim is automatically disabled during a turn.
 - Rate limit: The rate the vessel is turning in degrees per minute.
- Minimum rudder: Some boats may have a tendency of not responding to small rudder commands around the course keeping position because of a small rudder, a rudder deadband,

whirls/disturbance of the water-stream passing the rudder or it is a single nozzle water jet boat. By manually adjusting the minimum rudder function, the course keeping performance might be improved on some boats. This will however increase the rudder activity.

- Min wind angle starboard / Min wind angle port: This is the minimum apparent wind angle that will keep the sails well shaped and give an acceptable thrust. This parameter will vary from boat to boat. The setting applies for the tack-prevent function. It also applies when the autopilot is operating in WindNAV mode. You can select different minimum wind angles for port and starboard. The difference between port and starboard will be taken into account when calculating the Distance To Turn (DTT).
- Navigation change limit: Defines the limits for course change to next waypoint in a route. If the course change is more than this set limit, you are prompted to verify that the upcoming course change is acceptable

SG05 Autopilot computer

The SG05 Autopilot computer offers the same settings as the AC12N/AC42N Autopilot computers. Refer to "*AC12N/AC42N Autopilot computer*" on page 44.

7

Alarms

The system continuously checks for dangerous situations and system faults while the system is running. The alarm system can be activated if any alarm settings are exceeded.

Alarm indication

An alarm situation is indicated with an alarm pop-up. If you have enabled the siren, the alarm message is followed by an audible alarm.

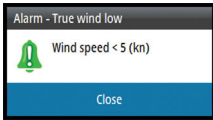

A single alarm is displayed with the name of the alarm as the title, and with details for the alarm.

If more than one alarm is activated simultaneously, the alarm pop-up can display 2 alarms. The alarms are listed in the order they occur with the alarm activated first at the top. The remaining alarms are available in the Alarms dialog.

Type of messages

The messages are classified according to how the reported situation affects your vessel. The following color codes are used:

Color	Importance
Red	Critical
Orange	Important
Yellow	Standard
Blue	Warning
Green	Light warning

Acknowledging the alarms

The most recent alarm is acknowledged by pressing the Enter key.

This removes the alarm notification, and silences the alarm from all units that belong to the same alarm group. A reminder reappears at given intervals for as long as the alarm condition exists.

→ **Note:** An alarm received from non Navico units on the network must be acknowledged on the unit generating the alarm.

Enabling the alarm system and the alarm siren

You enable the alarm system and the alarm siren from the Alarms menu.

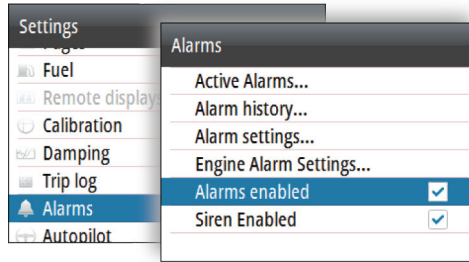

Individual alarm settings

You enable/disable the single alarm and set the alarm limits from the Alarms settings dialog.

- Press the Enter key to enable/disable the alarm
- Press the **MENU** key to show the menu from where you can access the alarm limits

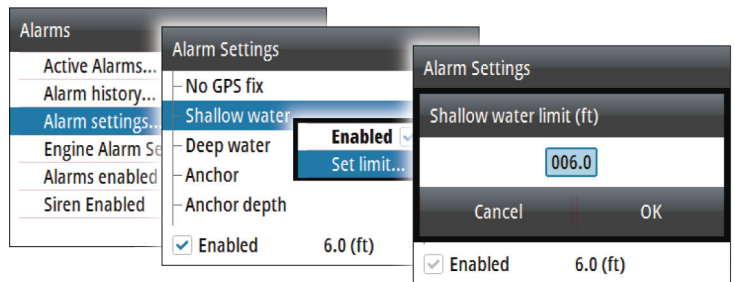

Alarm history

The Alarm history dialog stores alarm messages until they are manually cleared.

You show alarm details for a selected alarm and clear all alarms in the alarm history by pressing the **MENU** key when the Alarm history dialog is active.

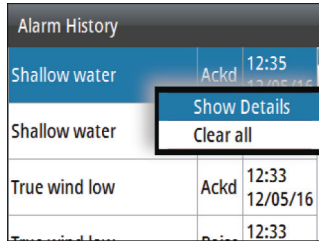

Alarm History		
Shallow water	Ackd	12:35
Shallow water		
True wind low	Ackd	12:33
		12/05/16
		12:33

Menu options

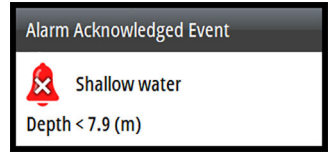

Alarm details

Alarm limits on analog pages

The analog true wind speed (TWS) and depth full-screen pages indicate the high and low alarm limit settings as red warning zones. This gives you a visual indication of alarm zones.



True Wind Speed page showing high and low true wind limits

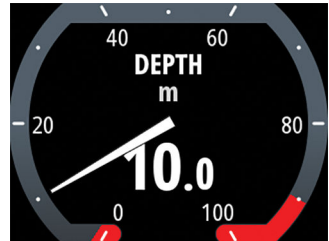

Depth page showing shallow and deep water limits

8

Software setup

Prior to use, the IS42 requires a number of settings be configured in order for the system to perform as expected. Access to the required options are found in the Settings menu, accessed from the page menu or by pressing the **MENU** key twice.

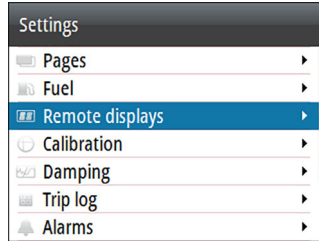

→ **Note:** The following settings are described in other sections of this manual:

"Pages" on page 14

"Trip log" on page 24

"Alarms" on page 48

"Autopilot settings" on page 41

"AIS settings" on page 30

Fuel

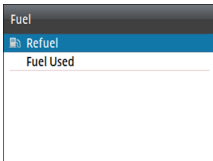

The fuel utility monitors a vessel's fuel consumption. This information is totaled to indicate trip and seasonal fuel usage, and is used to calculate fuel economy.

To use the utility, a Navico Fuel Flow sensor, or a NMEA 2000 engine adaptor cable/gateway with Navico Fuel Data Storage device must be fitted to the vessel. Neither the Navico Fuel Flow sensor, nor the Suzuki engine interface require the use of a separate Fuel Storage device. Refer to the engine manufacturer or dealer for information on whether or not your engine provides a data output, and what adaptor is available to connect to NMEA 2000.

To have accurate fuel information the engine setup must be completed, and the fuel sensor must be calibrated according to the separate documentation following the sensor. Refer to "*Engine setup*" on page 63 and to "*Sources*" on page 58.

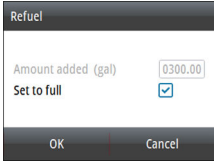

Adding fuel

To accurately calculate fuel capacity, fill the tank and select **Set to full** in the Refuel dialog.

Fuel used

The fuel Used dialog shows how much fuel has been used since last fill, from trip reset and seasonal usage (continuous recording).

If more than one engine is on the network, then the Fuel Used data shown is the total for all engines. It also lists the data for each engine.

The **Reset** option in the dialog allows resetting the fuel used data. You can reset all engines or each engine separately.

Remote displays

Any compatible B&G HV display connected to the network can be configured to show desired data via the IS42.

All HV Displays are listed in the Remote displays dialog. Displays not present on the network are greyed out.

1. Select the type of display you want to configure
 - Connected displays of the selected type are listed
2. Highlight the display you want to configure
 - The HV display itself starts flashing
3. Press the **MENU** key to display the options available:

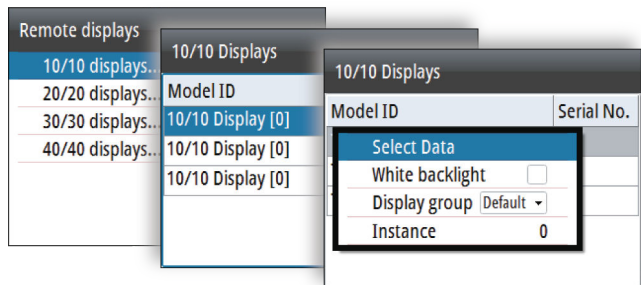

- Select data: Used for defining which data that should be displayed on the selected HV display
- White backlight: Sets the the backlight to white

→ **Note:** This option is not available for the 40/40 HV display

- Display group: Sets the network group for the unit
- Instance: Sets the network instance for the unit

For more information about network groups and instance settings, refer to "*Network*" on page 58.

Calibration

→ **Note:** Once the unit is setup and before you proceed with calibration ensure all network sources are selected and configured. Refer to "*System settings*" on page 58.

Boat speed

Speed calibration is necessary to compensate for hull shape and paddlewheel location on your boat. For accurate speed and log readings, it is essential that the paddlewheel is calibrated.

SOG reference

This is an auto calibration option that uses speed over ground (SOG) from your GPS, and compares the average of SOG against the average boat speed from the speed sensor for the duration of the calibration run.

→ **Note:** This calibration should be made in calm sea with no effect from wind or tidal current.

- Bring the boat up to cruising speed (above 5 knots), then
- Select the **SOG reference** option

When the calibration is completed the Boat speed calibration scale will show the adjusted percentage value of the boat speed.

Distance reference

Allows you to calibrate the log via a distance reference. You will need to complete consecutive runs, under power at a constant speed made along a given course and distance.

→ **Note:** The distance should be greater than 0.5 NM, ideally 1 NM. To eliminate the effect of tidal conditions it is advisable to perform at least two runs, preferably three, along the measured course.

Referring to the diagram, **A** and **B** are the markers for each run. **X** is the actual distance for each run.

- Enter the desired distance in nautical miles that you would like to calculate the distance reference over
- When the boat gets to the predetermined starting position of the distance reference calculation, start the calibration timer
- As the boat passes marks **A** and **B** on each run, instruct the system to start and stop and finally OK to end calibration.

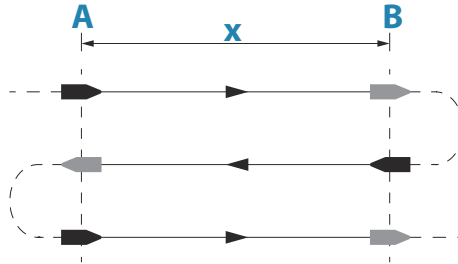

Use SOG as boat speed

If boat speed is not available from a paddle wheel sensor, it is possible to use speed over ground from a GPS. SOG will be displayed as boat speed and used in the true wind calculations and the speed log.

Wind

MHU (Masthead unit) alignment

This provides an off set calibration in degrees to compensate for any mechanical misalignment between the masthead unit and the center line of the vessel.

To check the masthead unit alignment error we recommend you use the following method which involves a sailing trial:

- Sail on a starboard tack on a close hauled course and record the wind angle, then repeat the process on a port tack
- Divide the difference between the two recorded numbers and enter this as the wind angle off set

If the starboard apparent wind angle is greater than the port angle, then divide the difference by 2 and enter this as a negative offset.

If the port angle is greater than the starboard then divide the difference by 2 and enter this as a positive offset.
Enter the offset it into the MHU Align calibration field.

Depth

Depth offset

All transducers measure water depth from the transducer to the bottom. As a result, water depth readings do not account for the distance from the transducer to the lowest point of the boat (for example; bottom of the keel, rudder, or propeller) in the water or from the transducer to the water surface.

- For depth below keel (**A**): Set the distance from transducer to the bottom of the keel as a negative value. For example, -2.0.
- For depth below transducer (**B**): no offset required.
- For depth below surface (waterline) (**C**): Set the distance from transducer to the surface as a positive value. For example, +0.5.

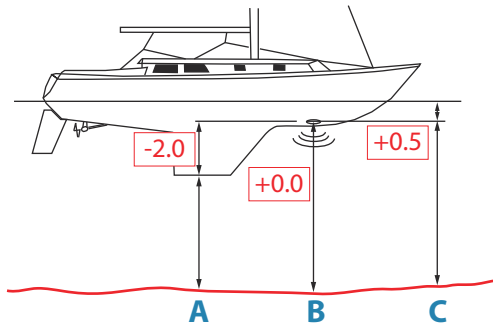

Aft depth offset

This option allows the system to display two depth readings.

The Aft depth is calibrated in the same manner as the Depth offset.

- **Note:** Aft Depth is only available when a valid signal is received from a second and compatible NMEA 2000 or NMEA 0183 device.

Heading

- **Note:** All magnetic compasses must be calibrated to ensure correct heading reference.
The calibration must be made on the active compass.
The calibration should be done in calm sea conditions and with minimal wind and current to obtain good results.

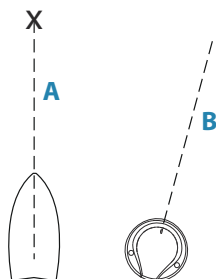

Offset

The **Offset** option is used for compensating for any difference between the boat's center line (A) and the compass lubber line (B).

1. Find the bearing from the boat position to a visible object. Use a chart or a chart plotter
 2. Steer the boat so that the center line of the boat is aligned with the bearing line pointing towards the object.
 3. Change the offset parameter so that the bearing to the object and the compass readout becomes equal.
- **Note:** Make sure that both the compass heading and the bearing to the object have the same unit ($^{\circ}$ M or $^{\circ}$ T).

User triggered calibration

- **Note:** Before the calibration is started, make sure that there is enough open water around the vessel to make a full turn.

The **Calibrate** option is used for manually starting the heading calibration procedure.

During this calibration, the compass measures the magnitude and direction of the local magnetic field.

The illustration shows magnitude of local field in percentage of earth's magnetic field (A), direction of local field (B) with respect to the boat's centerline (C).

Follow the on-screen instruction, and use about 60-90 seconds to make a full circle. Keep turning until the system reports a pass.

- If the local magnetic field is stronger than the earth's magnetic field (the local field is reading more than 100%), the compass calibration will fail.
- If the local field is reading more than 30%, you should look for any interfering magnetic objects and remove them, or you

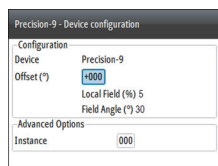
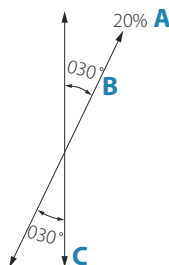

should move the compass to a different location. The (local) field angle guides you to the local interfering magnetic object.

- **Note:** In certain areas and at high latitudes the local magnetic interference becomes more significant, and heading errors exceeding $\pm 3^\circ$ may have to be accepted.

Automatic calibration

The **Auto calibrate** option is used for compasses that offers a fully automatic calibration procedure.

See more instructions in the documentation delivered with your compass.

Magnetic variation

Defines how magnetic variation is handled by the system.

- Auto: Receives variation data from a network source
- Manual: Used for manually entering a value for the magnetic variation

Use COG as heading

If heading data is not available from a compass sensor, it is possible to use COG from a GPS. COG will be used in the true wind calculations.

- **Note:** The autopilot cannot be operated using COG as the heading source. COG cannot be calculated when stationary.

Pitch/Roll

If a suitable sensor is fitted, the system will monitor the inclination of the vessel. The offset value should be entered to adjust the readings so that while the vessel is stationary at the dock, the **Pitch** and **Roll** value reads 0.

Environment

If a suitable sensor is fitted, the system will monitor the current sea/air temperature and barometric pressure.

The offset value to be entered should adjust the reading from the sensor to match a calibrated source.

Rudder

Starts the automatic calibration of the rudder feedback. This procedure sets the correct relationship between the physical rudder movement and the rudder angle readout.

Follow the instructions on the display to perform the rudder feedback calibration procedure.

Advanced

This option is used for manually applying an offset to the displayed data for third party sensors which cannot be calibrated through the IS42.

Damping

If data appears erratic or too sensitive, damping may be applied to make the information appear more stable. With damping set to off, the data is presented in raw form with no damping applied.

→ **Note:** Damping settings are applied to units belonging to the same damping group. Refer to *"Network groups"* on page 61.

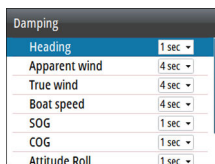

Damping	
Heading	1 sec ▾
Apparent wind	4 sec ▾
True wind	4 sec ▾
Boat speed	4 sec ▾
SOG	1 sec ▾
COG	1 sec ▾
Attitude Roll	1 sec ▾

System settings

Network

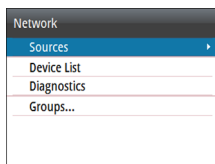

Network	
Sources	▶
Device List	
Diagnostics	
Groups...	

Sources

Data sources provide live data to the system.

The data may originate from modules internal to the unit (for example internal GPS or sonar), or external modules connected to the NMEA 2000 or via NMEA 0183 if available on the unit.

When a device is connected to more than one source providing the same data, the user can choose the preferred source. Before commencing with source selection make sure all external devices and the NMEA 2000 backbone are connected and are turned on.

- Auto select: Looks for all sources connected to the device. If more than one source is available for each data type, selection is made from an internal priority list. This option is suitable for the majority of installations.

- Manual source selection: Manual selection is generally only required where there is more than one source for the same data, and the automatically selected source is not the one desired.

Device list

The Device list shows the devices that provide data. This may include a module inside the unit, or any external NMEA 2000 device.

Model ID
AC12-1 Autopilot
AP44 Autopilot Controller
IS42 Instrument
IS42 Instrument
Precision-9

Selecting a device in this list will bring up additional details and actions:

IS42 Instrument - Device Inform...	
Device:	IS42 Instrument
Manufacturer:	Simrad
Software Ver:	01000_E1.0.54.3.10
Model:	
Address:	24
S/N:	006709#
Instance:	0
Status:	OK
	Configure
	Data

All devices allow allocation of an instance number in the configure option. Set unique instance numbers on any identical devices on the network to allow for the unit to distinguish between them. The data option shows all data being output by the device. Some devices will show additional options specific to the device.

➔ **Note:** Setting the instance number on a 3rd party product is typically not possible.

Diagnostics

The NMEA 2000 tab on the diagnostics page can provide information useful for identifying an issue with the network.

→ **Note:** The following information may not always indicate an issue that can be simply resolved with minor adjustment to network layout or connected devices and their activity on the network. However, Rx and Tx errors are most likely indicating issues with the physical network, which may be resolved by correcting termination, reducing backbone or drop lengths, or reducing the number of network nodes (devices).

Bus state

Simply indicates whether the bus is powered, but not necessarily connected to any data sources. However, if bus shows as 'off', but power is present along with an increasing error count, it is possible that termination or cable topology is incorrect.

Rx Overflows

The unit received too many messages for its buffer before the application could read them.

Rx Overruns

The unit contained too many messages for its buffer before the driver could read them.

Rx/Tx Errors

These two numbers increase when there are error messages, and decrease when messages are received successfully. These (unlike the other values) are not a cumulative count. Under normal operation these should be at 0. Values around 96 upwards indicate a heavily error prone network. If these numbers go too high for a given device, it will automatically drop off the bus.

Rx/Tx Messages

Shows actual traffic in and out of device.

Bus Load

A high value here indicates network is near full capacity. Some devices automatically adjust rate of transmission, if network traffic is heavy.

Fast Packet Errors

Cumulative counter of any fast packet error. This could be a missed frame, or a frame out of sequence etc. NMEA 2000 PGNs are made

of up to 32 frames. The entire message will be discarded when a frame is missed.

→ **Note:** Rx and Tx Errors often indicate an issue with the physical network, which may be resolved by correcting termination, reducing backbone or drop lengths, or reducing the number of network nodes (devices).

Network groups

The Network Group function is used to control parameter settings, either globally or in groups of units. The function is used on larger vessels where several units are connected to the network. By assigning several units to the same group, a parameter update on one unit will have the same effect on the rest of the group members.

Units

Provides setup of units of measure used on various data types.

Decimal places

Defines number of decimals used for speed and sea temperature.

Key beeps

Controls the loudness of the beep sound when a key is pressed.

Default setting: Loud

Language

Controls the language used on this unit for panels, menus, and dialogs. Changing the language causes the unit to restart.

Time

Controls the local time zone offset, and the format of the time and date.

Display setup

Displays the Display setup dialog.

The following options are available:

- Backlight level: Adjusts the backlight level from Min (10%) to Max (100%) in 10% increments
 - When the Backlight level field is active, subsequent presses on the backlight key adjusts backlight level in decrements of 30%
- Display group: Defines which network group the unit belongs to
- Night mode: Activates/deactivates the night mode color palette
- Night mode color: Sets the night mode color palette
- Invert day color: Changes the background color for the pages from default black to white
- Sleep: Turns the backlight for screen and keys off to save power

Display mode

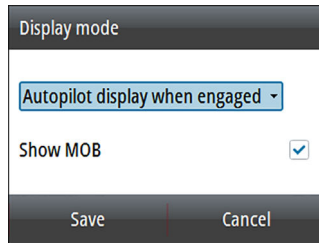

The IS42 unit can set up as an instrument only, as an autopilot display only, or as a combination of those two display modes.

- Instrument display only: Displays active data pages. The Autopilot page can be one of these data pages
- Autopilot display only: Displays only the autopilot page
- Autopilot display when engaged: Switches automatically to the Autopilot page when the autopilot is switched to an automatic mode. When the autopilot is switched to Standby mode the display switches back to the previous page. This behaviour does not require that an Autopilot page selected is as one of the 8 enabled pages

The Display mode dialog have the following additional options:

- Show MOB: Switches automatically to the MOB page if a Man Over Board event is triggered from another system on the network. Refer to "*Man Over Board (MOB)*" on page 13

Files

File management system. Used to browse the contents of the unit's internal memory and the content of a device plugged into the unit's USB port.

Simulate

Runs the display with simulated data. Use the simulator to become familiar with your unit before using it on the water.

When activated, the simulator mode is indicated on the display.

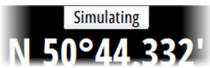

Restore defaults

Allows you to select which settings are to be restored to their original factory settings.

Engine setup

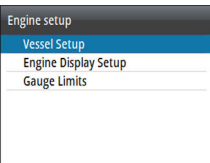

Vessel setup

Set the number of engines, fuel tanks and total fuel capacity.

Engine display setup

A maximum of two engine's data can be shown on each gauge.

The Engine display setup defines which engine's data should be displayed on a gauge if you have more than 2 engines.

Gauge limits

Sets the RPM and vessel fuel rate limits.

→ **Note:** These limits are a visual guide on the data pages. They do not set any alarms.

Global reset

Resets the source selection on all displays connected to the network.

About

Displays copyright information, software version, and technical information for this unit.

9

Maintenance

Preventive maintenance

The unit does not contain any field serviceable components. Therefore, the operator is required to perform only a very limited amount of preventative maintenance.

It is recommended that you always fit the supplied protective sun cover when the unit is not in use.

Cleaning the display unit

A proper cleaning cloth should be used to clean the screen, where possible. Use plenty of water to dissolve and take away salt remains. Crystallized salt may scratch the coating if using a damp cloth. Apply minimal pressure to the screen.

Where marks on the screen cannot be removed by the cloth alone, use a 50/50 mixture of warm water and isopropyl alcohol to clean the screen. Avoid any contact with solvents (acetone, mineral turpentine, etc.), or ammonia based cleaning products, as they may damage the anti-glare layer or plastic bezel.

To prevent UV damage to the plastic bezel, it is recommended that the sun cover be fitted when the unit is not in use for an extended period.

Checking the connectors

The connectors should be checked by visual inspection only.

Push the connector plugs into the connector. If the connector plugs are equipped with a lock, ensure that it is in the correct position.

Software update

The IS42 includes a USB port of the back of the units. You use this port for software updates.

You can update the software for the IS42 unit itself and for NMEA 2000 sensors connected to the network from the IS42.

You can check the units software version from the About dialog.

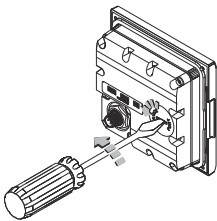

About	
Product	IS42
Application	1.0.54.3.10
Platform	21.0.34-g1fe7472
Serial number	013372#
Language pack	Standard
Up time	0:00:27 hrs
Copyright	2016 Navico

The software version for connected NMEA 2000 sensors is available in the Device list.

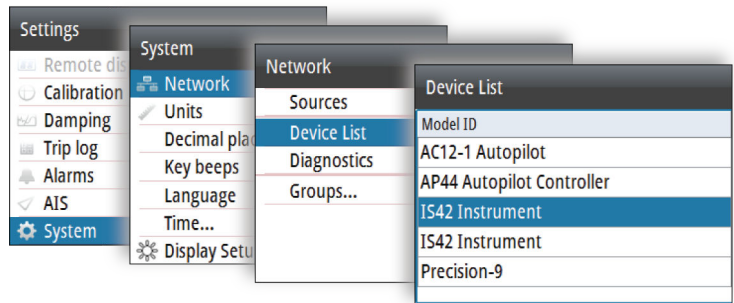

The latest software is available for download from our website: www.simrad-yachting.com.

Software update for the unit

1. Download the latest software from our website: www.simrad-yachting.com, and save it to a USB device
2. Insert the USB device to the IS42 unit, and restart the IS42 unit
 - The upgrade will now start automatically the upgrade procedure for all units
3. Remove the USB device when the update is completed.

⚠ Warning: Do not remove the USB device until the update is completed. Removing the USB device before the update is completed may damage the unit.

Software update for remote devices

- 1.** Download the latest software from our website: www.simrad-yachting.com, and save it to a USB device
- 2.** Insert the USB device to the IS42 unit
- 3.** Start the File explorer, and select the update file on the USB device
- 4.** Start the update from the file details dialog
- 5.** Remove the USB device when the update is completed.

10

Menu flow chart

The system includes two menu categories: Page menus and Settings menu.

Each page has a Page menu, accessed by pressing the **MENU** key once. The page menu includes basic functions for that panel. All page menus include access to the Settings menu.

The Settings menu is accessed from the page menus or by pressing the **MENU** key twice. The Settings menu gives access to settings for the sensors, the vessel and for the system.

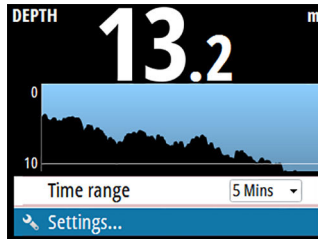

Page menu, Depth history page

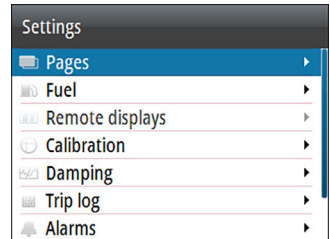

Settings menu

Page menus

Each page has a page menu, accessed by pressing the **MENU** key. If relevant, the page menu includes basic functions for that panel. All page menus include access to the Settings dialog.

Settings menu

Level 1	Level 2
Pages	Pages...
	AutoScroll
	AutoScroll time
Fuel	Refuel
	Fuel Used

Level 1	Level 2
Remote displays	10/10 displays...
	20/20 displays...
	30/30 displays...
	40/40 displays...
Calibration	Boat speed...
	Wind...
	Depth...
	Heading...
	Roll/Pitch...
	Environment...
	Rudder...
	Advanced...
Damping	Heading
	Apparent wind
	True wind
	Boat speed
	SOG
	COG
	Attitude Roll
	Attitude Pitch
	Tide
Trip log	Trip 1...
	Trip 2...
	Log...
Alarms	Active Alarms...
	Alarm history...
	Alarm settings...
	Engine Alarm Settings...
	Alarm enabled
	Siren Enabled

Level 1	Level 2
Autopilot, NAC-2 and NAC-3 * Refer to the NAC-2/NAC-3 Commissioning manual (988-11233-00n)	Steering
	Sailing
	Installation *
Autopilot, AC12N/AC42N ** Refer to the AC12N/AC42N Installation manual (988-10276-00n)	Response
	Sea state filter
	Sailing
	Automatic steering
	Installation **
AIS	Dangerous vessels...
	Speed and course
	AIS icon orientation
	MMSI...
System	Network
	Units
	Decimal places
	Key beeps
	Language
	Time...
	Display Setup...
	Display mode...
	Files
	Simulate
	Restore defaults...
	Engine setup
	Global reset...
	About

11

Technical specification

Dimensions	Refer to " <i>Dimensional drawing</i> " on page 72
Weight	0.32 kg (0.7 lbs)
Power consumption	1.8 Watts
Key backlight off	0.54 W
Key backlight max	1.35 W
Network load	3 LEN
Color	Black
Display	
Size	4.1" (diagonal). 4:3 Aspect ratio
Type	Transmissive TFT-LCD. White LED backlight
Resolution	320 x 240 pixels
Illumination	White for day mode. Red, green, blue or white for night mode
Environmental protection	
Waterproof rating	IPx7
Humidity	100% RH
Temperature	
Operating	-25° to +65°C (-13°F to +149 °F)
Storage	-40° to +85°C (-40°F to +185 °F)

12

Dimensional drawing

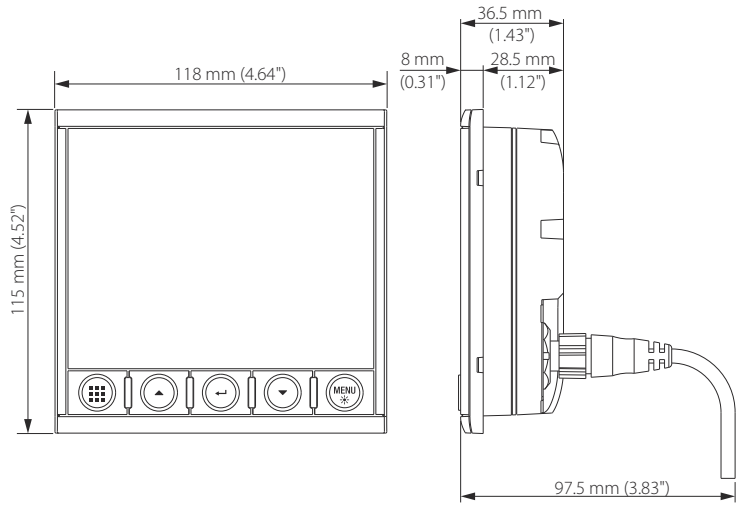

13

Terms and abbreviations

This list shows terms and abbreviations used in the pages and in dialogs in the IS42 system.

AIR TEMP	Air temperature
AIS	Automatic Identification System
AVG SPD	Average speed
AWA	Apparent wind angle
AWS	Apparent wind speed
BSPD	Boat speed
BTW	Bearing to waypoint
BWW	Bearing Waypoint To Waypoint
COG	Course Over Ground
CTS	Course To Steer
DGPS	Differential Gps
DTW	Distance to next waypoint
DSC	Digital Selective Calling
EPFS	Electronic Position Fixing System
EPIRB	Emergency Position Indicating Radio Beacon
ETA	Estimated Time Of Arrival
ETW	Estimated time of arrival to next waypoint
GLONASS	Global Orbiting Navigation Satellite System
GMDSS	Global Maritime Distress And Safety System
GNSS	Global Navigation Satellite System
GPS	Global Positioning System
HDG	Heading
Km	Kilometer
KN	Knots
LL DIST	Layline distance
LL TIME	Layline time
m	Meters

MAX SPD	Maximum speed
MIN	Minimum
MOB	Man Over Board
NM	Nautical Mile
OPP HDG	Heading on opposite tack
POS	Position
RM	Relative Motion
RNG	Range
ROT	Rate Of Turn
RTE	Route
SAR	Search And Rescue
SOG	Speed Over Ground
SPD	Speed
STBD	Starboard
STW	Speed Through Water
TCPA	Time To Closest Point Of Approach
TGT	Target
TIME LOC	Local time
TM	True Motion
TRK	Track
TRK CRS	Track course to next waypoint
TWA	True wind angle
TWD	True wind direction
TWS	True wind speed
WOL	Wheel Over Line
WOP	Wheel Over Point
WPT	Waypoint name
WPT BRG	Bearing to waypoint
WPT DIST	Distance to waypoint
XTE	Cross track error

14

Supported data

NMEA 2000 PGN (transmit)

59904	ISO Request
60928	ISO Address Claim
126208	ISO Command Group Function
126996	Product Info
127258	Magnetic Variation

NMEA 2000 PGN (receive)

59392	ISO Acknowledgement
59904	ISO Request
60928	ISO Address Claim
126208	ISO Command Group Function
126992	System Time
126996	Product Info
127237	Heading/Track Control
127245	Rudder
127250	Vessel Heading
127251	Rate of Turn
127257	Attitude
127258	Magnetic Variation
127488	Engine Parameters, Rapid Update
127489	Engine Parameters, Dynamic
127493	Transmission Parameters, Dynamic
127505	Fluid Level
127508	Battery Status
128259	Speed, Water referenced
128267	Water Depth

128275	Distance Log
129025	Position, Rapid Update
129026	COG & SOG, Rapid Update
129029	GNSS Position Data
129033	Time & Date
129038	AIS Class A Position Report
129039	AIS Class B Position Report
129040	AIS Class B Extended Position Report
129041	AIS aids to Navigation
129283	Cross Track Error
129284	Navigation Data
129283	Cross Track Error
129284	Navigation Data
129539	GNSS DOPs
129540	GNSS Sats in View
129794	AIS Class A Static and Voyage Related Data
129801	AIS Addressed Safety Related Message
129802	AIS Safety Related Broadcast Message
129808	DSC Call Information
129809	AIS Class B "CS" Static Data Report, Part A
129810	AIS Class B "CS" Static Data Report, Part B
130074	Route and WP Service - WP List - WP Name & Position
130306	Wind Data
130310	Environmental Parameters
130311	Environmental Parameters
130312	Temperature
130313	Humidity
130314	Actual Pressure
130576	Small Craft Status
130577	Direction Data



SIMRAD

