



Our Products Are Made in the USA

C-1002 Operation Manual

SKU: SSDC1002-ROC

Keep Americans working, buy made in the USA!



(Complies with "Buy American Act" — may contain imported components)



Patent Pending

Batteries installed and ready for immediate use

Please READ INSTRUCTIONS before use or servicing

Contents

1	FEATURES.....	4
2	SAFETY WARNINGS.....	4
3	MODES.....	4
3.1	Manual Mode.....	4
3.2	Bluetooth Mode 	4
4	CHANGING BATTERIES.....	5
4.1	RTCM/USCG requirement 6.2.3: Replacement of power supply.....	5
4.2	Reinstalling the LED Module.....	6
5	SPECIFICATIONS.....	7
5.1	Environment.....	7
5.2	Buoyancy.....	7
5.3	LED Wavelength.....	7
5.4	Run Time.....	7
5.5	Average Effective Intensity for Visual Light.....	7
5.6	Average Effective Intensity for Infrared Light.....	7
5.7	Sure Swift Paddle Switch Design.....	7
5.8	Battery Requirement DO NOT USE RECHARGEABLES.....	7
5.9	Bluetooth 	8
5.10	Dimensions.....	8
5.11	Weight.....	8
5.12	Additional Compliance.....	8
6	DISPLAYING THE LIGHT.....	8
7	MAINTENANCE AND SERVICE PARTS.....	9
8	THE SIRIUS SIGNAL SYSTEM.....	9
9	THE SIRIUS SIGNAL MOBILE APP.....	9
9.1	Installation of Mobile App.....	9
	Android.....	9
	iPhone.....	9
9.2	Operation of Mobile App.....	10

9.2.1 Home Page	10
9.2.2 Test Device	10
9.2.3 Start Trip/Float Plan	10
9.2.4 Contacts.....	11
9.2.5 Check-Me Function  ME	11
9.2.6 911 Function	11
9.2.7 First Aid.....	12
10 TROUBLESHOOTING.....	12
10.1 Light Won't Light	12
10.2 Only Half the LEDs Light	12
10.3 Mobile App Issue	13
Error message pops up when sending Check-Me  /SOS message or registering the product code in the mobile app—and the internet works fine in other apps.....	13

Figures

Figure 1: Polarity of CR2032 Coin Cell	6
Figure 2: Polarity of CR123A Batteries	6
Figure 3: Installation of CR123A Batteries in Battery Tray	6
Figure 4: Illustration of Collar Position When Properly Tightened.....	6
Figure 5: Collar Retention Tab	5
Figure 6: Reinstalling the LED Module.....	6

1 FEATURES



1.1 For Immediate USE manually turn on the light by setting the Sure Swift Paddle Switch two clicks fully to the right.  **DO NOT PULL DOWN OR PUSH UP ON SWITCH; IT OPERATES SIDE TO SIDE.**

1.2 Enable Bluetooth  mode by setting the switch to the center position.



1.3 ***Do not leave the unit switch in Bluetooth  mode unless checking device status or operating the light for distress situations.***

2 SAFETY WARNINGS

- 2.1 This is not a toy and should be treated as such. The 911 function should only be used in an emergency.
- 2.2 Use only premium CR123A lithium batteries.
- 2.3 Do not mix batteries from different manufacturers.
- 2.4 Do not mix fresh and used batteries.
- 2.5 Observe the proper polarity installation of the batteries.
- 2.6 Dispose of the used batteries properly.
- 2.7 Warning: Do not look directly at the light; it is extremely bright. In addition, it contains an infrared LED emitting infrared light that can't be seen.
- 2.8 The red collar can become warm during extended operation. If used as a handheld device, do not touch the collar during operation.

3 MODES



3.1 Manual Mode



With label facing toward you, turn the **Sure Swift Paddle Switch two clicks fully to the right**  (past the SECOND detente). **DO NOT PULL DOWN OR PUSH UP ON SWITCH; IT OPERATES SIDE TO SIDE.**

The light will begin the SOS pattern — 3 short orange/red flashes followed by 3 longer cyan flashes followed by 3 orange/red flashes. The pattern repeats. To turn unit off, fully return switch with left two clicks to the off  position marked on the label.

3.2 Bluetooth Mode

Move the **Sure Swift Paddle Switch** to the middle Bluetooth position  (past the FIRST detente). Open the Sirius Signal Mobile App (available by registering your device at SiriusSignal.com) and pair to the C-1002. The device battery status will be shown . It might take several seconds to connect. Upon connecting you have the option to test device. From the drop-down menu . Select test device and follow prompts the light will begin the SOS pattern: 3 short orange/red flashes followed by 3 longer cyan flashes

followed by 3 orange/red flashes. The pattern repeats. End device test function and switch to the full off position ①. While in Bluetooth ⓧ mode if a 911 activation is sent the SOS light will turn on and run until emergency sequence is ended, or device is switched completely off ①.

Bluetooth ⓧ mode requires a cell phone with the Sirius Signal app to work.

! Do not leave the unit switch in Bluetooth ⓧ mode unless checking device status or operating the light for distress situations.

4 CHANGING BATTERIES

The light requires eight premium CR123A lithium batteries and one CR2032 lithium coin cell. The light will operate without the coin cell, but it is desired as a backup for the Bluetooth.

To replace the batteries, unscrew the red collar counterclockwise this will release the watertight seals. Gently lift the LED module out of the housing along with the red collar. Remove the spent batteries and replace them with the new batteries, observing the proper polarity. See Figures 2 and 3 on the next page. The polarity is shown on the battery holder for the CR123A batteries. Use good quality batteries. Replace the coin cell (CR2032) with the positive side facing the outside of the module. See Figure 1.

Collar retention tab RTCM/USCG tethering requirement.

4.1 RTCM/USCG requirement 6.2.3: Replacement of power supply

*“If the power supply (batteries) is user-replaceable, the replacement procedure shall not require the use of any tools. If the power supply compartment cover(s) is removable, it **must be tethered to the device to ensure against loss,**”*

The Sirius Signal yellow molded retention collar tab was designed to meet the tethering requirement. It does not need to be fully seated in the collar groove to prevent it from separating from the body. See Figure 5.



Figure 5.

4.2 Reinstalling the LED Module

Hold unit with label facing you. Check O-ring on top of the body for fitment in top groove, then carefully align the module to go back inside the housing. Take note of hole in the PC board. See Figure 6. Reinstall, making certain the hole goes over the red rotor shaft. Advance the collar slightly to engage threads. Do not cross the threads. Slowly turn the collar while gently rotating and pushing optic downward until it locks into place. Continue tightening the collar until it stops against float. Fully tightened, the raised bump should be past 12 o'clock. See Figure 4. **IF YOU EXPERIENCE ANY, DIFFICULTY STOP.** Unscrew the collar, remove the module, and then try again.



Figure 6.

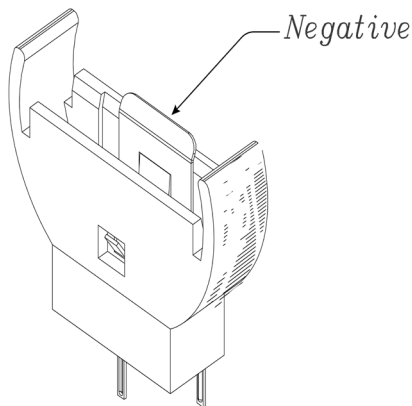

Figure 1: Polarity of CR2032 Coin Cell

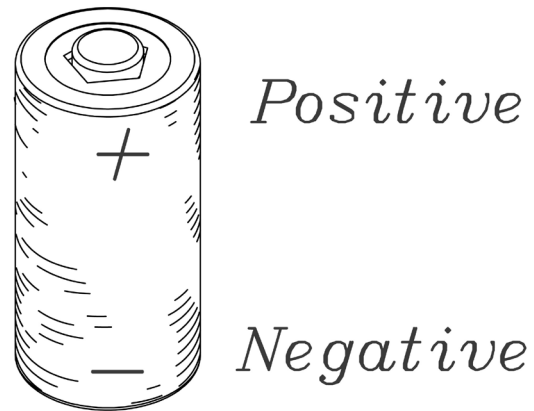

Figure 2: Polarity of CR123A Batteries

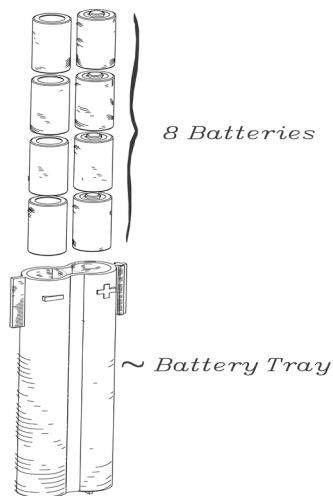

Figure 3: Installation of CR123A Batteries in Battery Tray

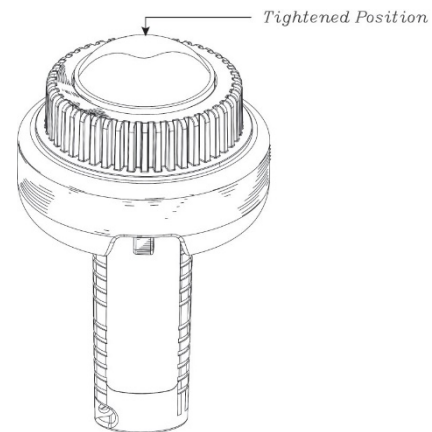

Figure 4: Illustration of Collar Position When Properly Tightened

5 SPECIFICATIONS

5.1 Environment

The operating temperature range is -1°C to +30°C (30.2°F to 86°F), and the storage temperature range is -20°C to +55°C (-4°F to 131°F).

5.2 Buoyancy

The device is capable of floating with the light output fully visible above the waterline in calm freshwater or saltwater.

5.3 LED Wavelength

The LED wavelength is 6 red/orange 610-620 nm 6 cyan 490-520nm 1 IR 740-890 (flashes USCG spec SOS signal in colors and infrared).

5.4 Run Time

Performance specification run time is two hours. The C-1002 has an innovative feature that allows the light to continue after the specified two hours at half power, illuminating half of the LEDs. This extends the total operational run time approximately four hours.





5.5 Average Effective Intensity for Visual Light

For the orange/red and cyan LEDs, the Average Effective Intensity exceeds 50cd in a hemispherical distribution.

5.6 Average Effective Intensity for Infrared Light

The infrared LED is 21mW/Sr output in a hemispherical distribution flashing SOS independently of the two visible colors.

5.7 Sure Swift Paddle Switch Design

The switch is designed to be activated with **one hand SIDE TO SIDE. With the label facing upward, the OFF  position is marked fully left, Bluetooth  is in the middle, and manual ON is far right.**  The added travel space in the Bluetooth  mode switch area provides additional momentum for a single-hand activation even with a glove on.

5.8 Battery Requirement **DO NOT USE RECHARGEABLES**

Requires eight CR123A batteries (included) and one CR2032 coin cell (included).

Device performance can vary widely by selection of batteries. Look for premium, high milliamp hour range batteries of at least 1600 mAh for optimal performance.

5.9 Bluetooth

Bluetooth-enabled with enhanced connectivity. 



Do not leave the unit switch in Bluetooth mode unless checking device status or operating the light for distress situations.

5.10 Dimensions

5.10.1 Height: 8.5" (21.59cm)

5.10.2 Diameter: 5" (12.70cm)

5.11 Weight

5.11.1 Without batteries: 1.080 lbs.

5.11.2 With batteries: 1.366 lbs.

5.11.3 Shipping weight (with packaging): 1.708 lbs., P/N SOS C-1002

5.12 Additional Compliance

5.12.1 CE (European Compliant)

5.12.2 RoHS Compliant

6 DISPLAYING THE LIGHT

The light can be used as a handheld location device that can be manually operated. In addition, it can be attached to the craft and displayed at a higher point so it can be seen at a greater distance. Put the light in Bluetooth mode . After positioning it, use the Sirius Signal app to turn it on.

The distance to the horizon—the practical limit on the distance any light can be seen—can be estimated by the following formula:

$$1.17 \times \sqrt{\text{Eye height above water (in feet)}} = \text{Distance to horizon (nautical miles)}$$

7 MAINTENANCE AND SERVICE PARTS

The light can be cleaned with a soft cloth and warm water. ***During routine battery replacement or inspection, if any seals look dry, apply a quality silicone grease on the seal surface. All service parts are available directly from Sirius Signal.***

8 THE SIRIUS SIGNAL SYSTEM

As a precision safety device, the light provides an intense visual SOS for greater than two hours. It is the "Locate" part of Sirius Signal's "Alert and Locate" system.

This system is composed of a Mobile App that comprises the "Alert" part of the system. This app allows you to send location data via text and phone calls to recipients you select to alert them you have a problem. The light provides the "Locate" function to allow respondents to find you.

9 THE SIRIUS SIGNAL MOBILE APP

You can register your device at <https://siriuussignal.com/owners/>. Registration allows you to download the Sirius Signal Mobile App to your phone; it's compatible with Android 5.0 and up and IOS 13.0 and up. You will be allowed multiple downloads of the Sirius app with the issued product code key. If you are not the original purchaser of the Sirius Signal C-1002 SOS eVDS, but it is part of your boat's safety equipment, you will need to re-register as the new owner of unit. Go to siriuussignal.com select "Register Your Device" tab.

9.1 Installation of Mobile App

See the presentation on our website, SiriusSignal.com/application, or follow the directions below.

Android

Search for Sirius Signal in the Google Play store or use the following link:

<https://play.google.com/store/apps/details?id=siriussignals.siriussignals>. Click "Install" on the Google Play profile screen. This will install the app on your device.

iPhone

Open the Apple Store App and search for the Sirius Signal app or use this link to go directly to the App Store download screen:

<https://apps.apple.com/app/id1501459745>. Once on the app profile screen, tap "Get" and tap "Install." This will install the app on your device.

9.2 Operation of Mobile App

Tap on the Sirius Signal icon to open the app.

9.2.1 Home Page

Main Menu Drop down ≡ Clicking the “Test Light” button toggles the light on or off if the switch on the light is in the center position Bluetooth mode ✂ (It might take a few seconds to pair to the phone the first time the button is pressed.)

Clicking the white “Start Trip” button sends you to the “Float Plan” form provided to inform others of the details of your trip.

Clicking on the Green Check-Me ✓ button causes the program to send the previously set up message to the previously set up list of Check-Me ✓ recipients.

Clicking on the red 911 button causes the program to send a boating Emergency Alert and a text to voice phone call to the previously set up list of emergency recipients with Google Map Location and an Emergency Alert Text to 911 operator also with Google Map Location

Clicking on the blue box or clicking on the triple bar on the upper left and choosing “Contacts” allows you to enter up to five contacts for the “Check-Me” ✓ or “911” functions.

9.2.2 Test Device

Periodically, the operation of the device should be checked by turning the light on manually ☰ — 2 clicks fully to right or via Bluetooth — 1 click to right ✂. The Sirius Signal App when paired will also report the battery condition on the App’s first page. Green signifies charged batteries; red signifies low charge.

Set the switch on the light to the center Bluetooth-mode position ✂. Open the Sirius Signal app on your mobile device. From the main menu select the “Test Light” button, it can take several seconds to connect. The light will then turn on and begin flashing the SOS pattern — 3 short orange/red flashes followed by 3 longer cyan flashes followed by 3 orange/red flashes. The pattern repeats. End device test function and move Sure Swift Paddle Switch to the full OFF ① Position.



9.2.3 Start Trip/Float Plan

Fill out the Float Plan to describe your trip. The float plan pulls recipients from the Check-Me ✓ contacts you selected earlier. Add the area of operation and destination. Enter your arrival time and press submit so respondents will know where you started and when you’re expected back.

In the event you don’t end your trip at the designated time the following sequence begins:
The App will remind you to end you trip at:

- At +15 Min & +30 minutes additional mobile device notification reminders will be sent.
- At 45 minutes, a Final Warning to End your trip will be sent.
- After one hour the app will send your Trip Map to your original float plan recipients with route info and last recorded position.

9.2.4 Contacts

Contacts are entered one by one. You can enter the information manually or import the entries from your phone's contact list. Also, there are two user definable contact lists, one for the Check-Me  function (float plan recipients are from this list as well) and one for the 911 function. There are labels above the list, Check-Me  and 911. Tap on the label to select that list.

To enter a contact in either list, select the "Add" button at the bottom of the Contacts menu. Either manually enter the information or import it.

To import a contact, select the "Import" button next to the blank contacts field. Check the box next to the entry you would like to import, then tap the check mark in the upper right of the page.

Import also includes a search function. Type in a name on your contact list and the app searches as you type.

Above the contact entry list but below the labels is a region where you can enter a transmittable message for either function. Type in a message to be sent as a text and as an electronic cell phone call (911 activation only). *For example in the 911 section, you might say, "Emergency; need assistance for the emergency message."* For the Check-Me  function, you might say, "The trip is going well; just checking in." You can change the message check at any time.

9.2.5 Check-Me Function ME

This feature allows you to "**check in**" with a previously defined group. A simple text notification is sent with your position. The Check-Me  created group recipient list allows up to 5 contact selections. The notification message can be changed, as necessary.

9.2.6 911 Function

This feature allows you to send an assistance required text message with location to a previously defined contact group or a 911 operator. The 911 created recipient group (up to 5 contact selections) will receive a text to voice call. This function should only be used in a real emergency. Suggested contacts might be a towing service and/or government response agencies.

9.2.7 First Aid

Click on the First Aid icon. On the sketch of a man, tap on the body part that has a problem. A list will appear. Tap on the applicable condition, this will activate a looped voice synthesized audio recording on how to address the issue. **THIS FEATURE IS ENABLED OFFLINE.**

10 TROUBLESHOOTING

10.1 Light Won't Light

10.1.1 Sure Swift Paddle Switch not in right position

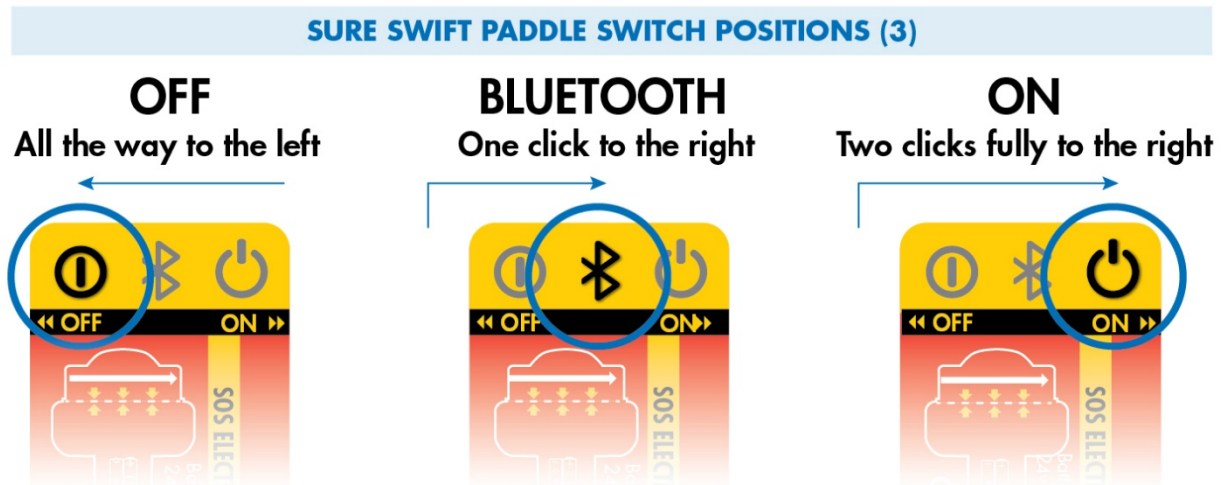

10.1.2 Batteries are exhausted.

Replace with eight CR123A good quality batteries.

10.1.3 One or more batteries are reversed.

Inspect batteries for correct polarity; correct if needed.

10.1.4 Battery or switch contacts are corroded.

Clean contacts with an eraser.

10.2 Only Half the LEDs Light

10.2.1 Batteries are exhausted.

Replace with eight CR123A good quality batteries. The C-1002 has a feature that allows the light to continue after the specified two hours at half power using half of the LEDs.

10.2.2 Broken wires.

Return to manufacturer for repair.

10.3 Mobile App Issue

Error message pops up when sending Check-Me /SOS message or registering the product code in the mobile app—and the internet works fine in other apps.

Solution #1: Check your VPN settings. Some websites and apps do not work when using VPN. VPN should be disabled when using the Sirius Signal app.

Android:

1. Open your phone's Settings app.
2. Tap Network & Internet, then Advanced, then VPN.
3. Next to the VPN you want to disconnect, tap Settings. 
4. Turn off that VPN.

Important: Settings can vary by phone. For more info, contact your device manufacturer.

IOS

Go to **Settings > VPN** and toggle it off.

