

FM/AM Digital Media Player

The warranty for this product is included in this manual (page 38, 39).
La garantie de ce produit est inclus dans le présent manuel (page 40).

Owner's Record

The model and serial numbers are located on the bottom of the unit. Record the serial number in the spaces provided below. Refer to these numbers whenever you call upon your Sony dealer regarding this product.

Model No. DSX-M55BT Serial No. _____

To cancel the demonstration (DEMO) display, see page 21.

To switch the FM/AM tuning step, see page 9.

For the connection/installation, see page 33.

Pour annuler l'affichage de démonstration (DEMO), reportez-vous à la page 22.

Pour commuter l'intervalle de syntonisation FM/AM, reportez-vous à la page 9.

Pour le raccordement/l'installation, reportez-vous à la page 35.

Para cancelar la pantalla de demostración (DEMO), consulte la página 22.

Para cambiar el paso de sintonización de FM/AM, consulte la página 9.

Para la conexión/instalación, consulte la página 35.

Operating Instructions GB

Mode d'emploi FR

Manual de instrucciones ES



* 4 5 8 8 3 2 4 1 1 * (1)

For safety, be sure to install this unit in the dashboard of the boat as the rear side of the unit becomes hot during use.
For details, see "Connection/Installation" (page 33).

The nameplate indicating operating voltage, etc., is located on the bottom of the chassis.

Warning

FOR THE CUSTOMERS IN THE USA. NOT APPLICABLE IN CANADA, INCLUDING IN THE PROVINCE OF QUEBEC.

POUR LES CLIENTS AUX ÉTATS-UNIS. NON APPLICABLE AU CANADA, Y COMPRIS LA PROVINCE DE QUÉBEC.

This equipment has been tested and found to comply with the limits for a Class B digital device, pursuant to Part 15 of the FCC Rules.

These limits are designed to provide reasonable protection against harmful interference in a residential installation. This equipment generates, uses, and can radiate radio frequency energy and, if not installed and used in accordance with the instructions, may cause harmful interference to radio communications. However, there is no guarantee that interference will not occur in a particular installation. If this equipment does cause harmful interference to radio or television reception, which can be determined by turning the equipment off and on, the user is encouraged to try to correct the interference by one or more of the following measures:

- Reorient or relocate the receiving antenna.
- Increase the separation between the equipment and receiver.
- Connect the equipment into an outlet on a circuit different from that to which the receiver is connected.
- Consult the dealer or an experienced radio/TV technician for help.

You are cautioned that any changes or modifications not expressly approved in this manual could void your authority to operate this equipment.

This device complies with Part 15 of the FCC Rules and Industry Canada's licence-exempt RSSs. Operation is subject to the following two conditions:

- (1) This device may not cause interference; and
- (2) This device must accept any interference, including interference that may cause undesired operation of the device.

This transmitter must not be co-located or operated in conjunction with any other antenna or transmitter.

Under Industry Canada regulations, this radio transmitter may only operate using an antenna of a type and maximum (or lesser) gain approved for the transmitter by Industry Canada. To reduce potential radio interference to other users, the antenna type and its gain should be so chosen that the equivalent isotropically radiated power (e.i.r.p.) is not more than that necessary for successful communication.

This equipment complies with FCC/IC radiation exposure limits set forth for an uncontrolled environment and meets the FCC radio frequency (RF) Exposure Guidelines and RSS-102 of the IC radio frequency (RF) Exposure rules. This equipment has very low levels of RF energy that is deemed to comply without maximum permissive exposure evaluation (MPE).

For the State of California, USA only

Perchlorate Material – special handling may apply, See www.dtsc.ca.gov/hazardouswaste/perchlorate

Made in Thailand



Hereby, Sony Corporation, declares that this equipment is in compliance with the essential requirements and other relevant provisions of Directive 1999/5/EC.

For details, please access the following URL: <http://www.compliance.sony.de/>

Notice for customers: the following information is only applicable to equipment sold in countries applying EU Directives

Manufacturer: Sony Corporation, 1-7-1 Konan Minato-ku Tokyo, 108-0075 Japan
For EU product compliance: Sony Belgium, bijkantoor van Sony Europe Limited, Da Vincilaan 7-D1, 1935 Zaventem, Belgium



Disposal of waste batteries and electrical and electronic equipment (applicable in the European Union and other European countries with separate collection systems)

This symbol on the product, the battery or on the packaging indicates that the product and the battery shall not be treated as household waste. On certain batteries this symbol might be used in combination with a chemical symbol. The chemical symbols for mercury (Hg) or lead (Pb) are added if the battery contains more than 0.0005% mercury or 0.004% lead.

By ensuring these products and batteries are disposed of correctly, you will help prevent potentially negative consequences for the environment and human health which could otherwise be caused by inappropriate waste handling. The recycling of the materials will help to conserve natural resources.

In case of products that for safety, performance or data integrity reasons require a permanent connection with an incorporated battery, this battery should be replaced by qualified service staff only.

To ensure that the battery and the electrical and electronic equipment will be treated properly, hand over these products at end-of-life to the applicable collection point for the recycling of electrical and electronic equipment. For all other batteries, please view the section on how to remove the battery from the product safely. Hand the battery over to the applicable collection point for the recycling of waste batteries.

For more detailed information about recycling of this product or battery, please contact your local Civic Office, your household waste disposal service or the shop where you purchased the product or battery.

Note on the lithium battery

Do not expose the battery to excessive heat such as direct sunlight, fire or the like.

Warning if your boat's ignition has no ACC position

Be sure to set the AUTO OFF function (page 21). The unit will shut off completely and automatically in the set time after the unit is turned off, which prevents battery drain. If you do not set the AUTO OFF function, press and hold OFF until the display disappears each time you turn the ignition off.

Disclaimer regarding services offered by third parties

Services offered by third parties may be changed, suspended, or terminated without prior notice. Sony does not bear any responsibility in these sorts of situations.

Important notice

Caution

IN NO EVENT SHALL SONY BE LIABLE FOR ANY INCIDENTAL, INDIRECT OR CONSEQUENTIAL DAMAGES OR OTHER DAMAGES INCLUDING, WITHOUT LIMITATION, LOSS OF PROFITS, LOSS OF REVENUE, LOSS OF DATA, LOSS OF USE OF THE PRODUCT OR ANY ASSOCIATED EQUIPMENT, DOWNTIME, AND PURCHASER'S TIME RELATED TO OR ARISING OUT OF THE USE OF THIS PRODUCT, ITS HARDWARE AND/OR ITS SOFTWARE.

Dear customer, this product includes a radio transmitter.

According to UNECE Regulation no. 10, vessel manufacturers may impose specific conditions for installation of radio transmitters into boats.

Please check your boat's operation manual or contact the manufacturer or your boat dealer, before you install this product.

Emergency calls

This BLUETOOTH boat handsfree and the electronic device connected to the handsfree operate using radio signals, cellular, and landline networks as well as user-programmed function, which cannot guarantee connection under all conditions. Therefore do not rely solely upon any electronic device for essential communications (such as medical emergencies).

On BLUETOOTH communication

- Microwaves emitting from a BLUETOOTH device may affect the operation of electronic medical devices. Turn off this unit and other BLUETOOTH devices in the following locations, as it may cause an accident.
 - where inflammable gas is present, in a hospital, train, airplane, or petrol station
 - near automatic doors or a fire alarm
- This unit supports security capabilities that comply with the BLUETOOTH standard to provide a secure connection when the BLUETOOTH wireless technology is used, but security may not be enough depending on the setting. Be careful when communicating using BLUETOOTH wireless technology.
- We do not take any responsibility for the leakage of information during BLUETOOTH communication.

If you have any questions or problems concerning your unit that are not covered in this manual, consult your nearest Sony dealer.

Table of Contents

Warning	2
Guide to Parts and Controls	6

Getting Started

Detaching the Front Panel	8
Switching the FM/AM Tuning Step	9
Setting the Clock	9
Preparing a BLUETOOTH Device	9
Connecting a USB Device	11
Connecting Other Portable Audio Device	12

Listening to the Radio

Listening to the Radio	12
Using Radio Data System (RDS)	13
Listening to the SiriusXM Radio (US/Canada only)	13

Playback

Playing a USB Device	15
Playing a BLUETOOTH Device	15
Searching and Playing Tracks	16

Listening to Pandora®

Setting up Pandora®	17
Streaming Pandora®	17
Available Operations in Pandora®	17

Handsfree Calling (via BLUETOOTH only)

Receiving a Call	18
Making a Call	18
Available Operations during Call	19

Useful Functions

Using Siri Eyes Free	20
----------------------	----

Settings

Canceling the DEMO Mode	21
Basic Setting Operation	21
General Setup (GENERAL)	21
Sound Setup (SOUND)	22
Display Setup (DISPLAY)	22
BLUETOOTH Setup (BT)	22

Additional Information

Precautions	23
Maintenance	24
Specifications	25
Troubleshooting	27

Connection/Installation

Cautions	33
Parts List for Installation	33
Connection	34
Installation	36

Important notice

The warranty for this product is included in this manual (page 38, 39). Keep this manual for future use.

Guide to Parts and Controls

Main unit

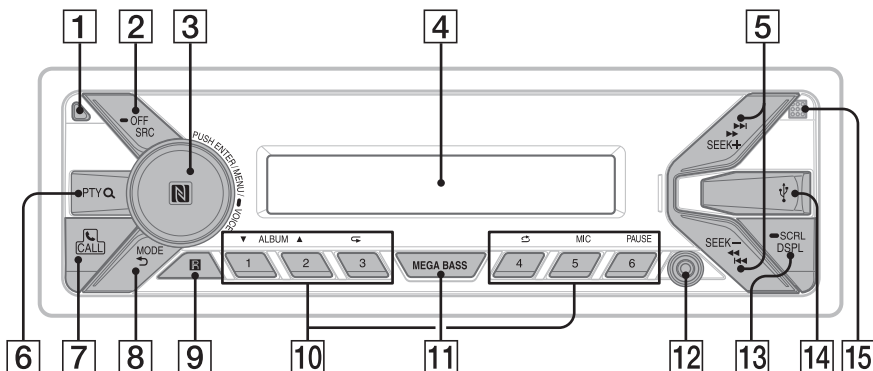

1 Front panel release button

2 SRC (source)

Turn on the power.
Change the source.

➔ OFF

Press and hold for 1 second to turn the source off and display the clock.
Press and hold for more than 2 seconds to turn off the power and the display.
If the unit is turned off and the display disappears, operation by the remote commander is not available.

3 Control dial

Rotate to adjust the volume.

PUSH ENTER

Enter the selected item.

MENU*

Open the setup menu.

➔ VOICE (page 19, 20)

Press and hold for more than 2 seconds to activate voice dial or the Siri function (iPhone only).

N-Mark

Touch the control dial with Android™ smartphone to make Bluetooth® connection.

* Not available when the BT phone is selected.

4 Display window

5 SEEK +/-

Tune in radio stations automatically. Press and hold to tune manually.

◀◀/▶▶ (prev/next)

◀◀/▶▶ (fast-reverse/fast-forward)

6 PTY (program type)

Select PTY in RDS.

Q (browse) (page 14, 16, 17)

Enter the browse mode during playback.

7 CALL

Enter the call menu. Receive/end a call.
Press and hold for more than 2 seconds to switch the BLUETOOTH signal.

8 MODE (page 12, 14, 15, 17, 19)

➔ (back)

Return to the previous display.

9 Receptor for the remote commander

10 Number buttons (1 to 6)

Receive stored radio stations. Press and hold to store stations.

Call a stored phone number. Press and hold to store a phone number.

ALBUM ▼/▲

Skip an album for audio device. Press and hold to skip albums continuously.

Press ▲ to thumbs up, or ▼ to thumbs down in Pandora® (page 17).

↺ (repeat)

↻ (shuffle)

MIC (page 19)

PAUSE

11 MEGA BASS

Reinforces bass sound in synchronization with the volume level. Press to change the MEGA BASS setting: [1], [2], [OFF].

12 AUX input jack

13 DSPL (display)

Press to change display items.

➡ SCRL (scroll)

Press and hold to scroll a display item.

14 USB port

15 Microphone (inner panel)

In order for the handsfree function to work properly, do not cover the microphone with tape, etc.

RM-X231 Remote commander

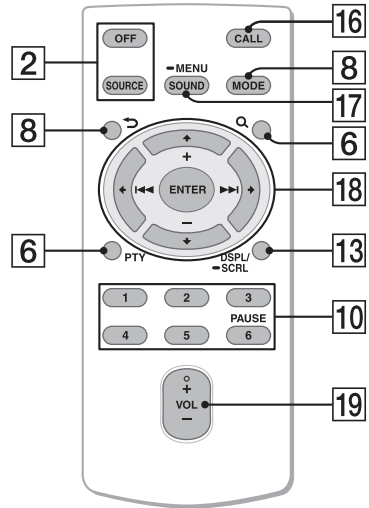

The VOL (volume) + button has a tactile dot.

16 CALL

Enter the call menu. Receive/end a call.

17 SOUND*

Open the SOUND menu directly.

➡ MENU*

Press and hold to open the setup menu.

* Not available when the BT phone is selected.

18 ◀/▶/↶/↷

Select a setup item, etc.

ENTER

Enter the selected item.

◀◀/▶▶ (prev/next)

+/- (album +/-)

19 VOL (volume) +/-

Remove the insulation film before use.

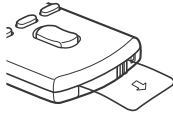

RM-X11M Marine remote commander (not supplied)

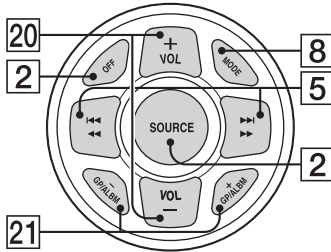

- 20 VOL (volume) +/-
- 2 GP (group)/ALBM (album) +/-
Receive stored stations.

Getting Started

Detaching the Front Panel

You can detach the front panel of this unit to prevent theft.

- 1 Press and hold OFF ① until the unit turns off, press the front panel release button ②, then pull the panel towards you to remove.

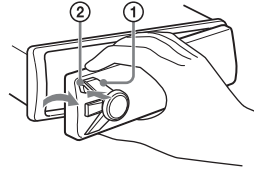

Caution alarm

If you turn the ignition switch to the OFF position without detaching the front panel, the caution alarm will sound for a few seconds. The alarm will only sound if the built-in amplifier is used.

Serial numbers

Make sure the serial numbers on the bottom of the unit and the back of the front panel are matched correctly. Otherwise you cannot make BLUETOOTH pairing, connection and disconnection by NFC.

Attaching the front panel

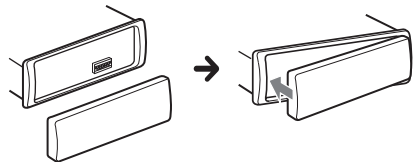

Switching the FM/AM Tuning Step

Set the FM/AM tuning step of your country. This setting appears **only while the source is off and the clock is displayed.**

- 1 Press MENU, rotate the control dial to select [SET GENERAL], then press it.
- 2 Rotate the control dial to select [SET TUNER-STP], then press it.
- 3 Rotate the control dial to select from [SET 50K/9K], [SET 100K/10K] or [SET 200K/10K], then press it.

Setting the Clock

- 1 Press MENU, rotate the control dial to select [SET GENERAL], then press it.
- 2 Rotate the control dial to select [SET CLOCK-ADJ], then press it.
The hour indication flashes.
- 3 Rotate the control dial to set the hour and minute.
To move the digital indication, press SEEK +/-.
- 4 After setting the minute, press MENU.
The setup is complete and the clock starts.

To display the clock

Press DSPL.

Preparing a BLUETOOTH Device

You can enjoy music, or perform handsfree calling depending on the BLUETOOTH compatible device such as a smartphone, cellular phone and audio device (hereafter “BLUETOOTH device” if not otherwise specified). For details on connecting, refer to the operating instructions supplied with the device.

Before connecting the device, turn down the volume of this unit; otherwise, loud sound may result.

Connecting with a Smartphone by One touch (NFC)

By touching the control dial on the unit with an NFC* compatible smartphone, the unit is paired and connected with the smartphone automatically.

* NFC (Near Field Communication) is a technology enabling short-range wireless communication between various devices, such as mobile phones and IC tags. Thanks to the NFC function, data communication can be achieved easily just by touching the relevant symbol or designated location on NFC compatible devices.

For a smartphone with Android OS 4.0 or lower installed, downloading the app “NFC Easy Connect” available at Google Play™ is required. The app may not be downloadable in some countries/regions.

- 1 **Activate the NFC function on the smartphone.**
For details, refer to the operating instructions supplied with the smartphone.
- 2 **Touch the N-Mark part of the unit with the N-Mark part of the smartphone.**

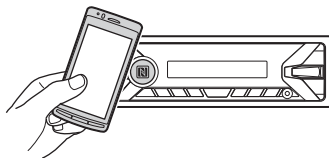

Make sure that  lights up on the display of the unit.

To disconnect by One touch

Touch the N-Mark part of the unit with the N-Mark part of the smartphone again.

Notes

- When making the connection, handle the smartphone carefully to prevent scratches.
- One touch connection is not possible when the unit is already connected to another NFC compatible device. In this case, disconnect the other device, and make connection with the smartphone again.

Pairing and connecting with a BLUETOOTH device

When connecting a BLUETOOTH device for the first time, mutual registration (called "pairing") is required. Pairing enables this unit and other devices to recognize each other.



- 1 Place the BLUETOOTH device within 1 m (3 ft) of this unit.
- 2 Press CALL, rotate the control dial to select [SET PAIRING], then press it.
Ⓜ flashes while the unit is in pairing standby mode.
- 3 Perform pairing on the BLUETOOTH device so it detects this unit.
- 4 Select [DSX-M55BT] shown in the display of the BLUETOOTH device.

If your model name does not appear, repeat from step 2.



- 5 If passkey* input is required on the BLUETOOTH device, input [0000].

* Passkey may be called "Passcode," "PIN code," "PIN number" or "Password," etc., depending on the device.

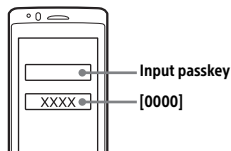

When pairing is made, Ⓜ stays lit.

- 6 Select this unit on the BLUETOOTH device to establish the BLUETOOTH connection.

Ⓜ or Ⓜ lights up when the connection is made.

Note

While connecting to a BLUETOOTH device, this unit cannot be detected from another device. To enable detection, enter the pairing mode and search for this unit from another device.

To start playback

For details, see "Playing a BLUETOOTH Device" (page 15).

To cancel pairing

Perform step 2 to cancel the pairing mode after this unit and the BLUETOOTH device are paired.

Connecting with a paired BLUETOOTH device

To use a paired device, connection with this unit is required. Some paired devices will connect automatically.





- 1 Press CALL, rotate the control dial to select [SET BT SIGNL], then press it.
Make sure that Ⓜ lights up.
- 2 Activate the BLUETOOTH function on the BLUETOOTH device.

3 Operate the BLUETOOTH device to connect to this unit.

 or  lights up.

Icons in the display:

	Lights up when handsfree calling is available by enabling the HFP (Handsfree Profile).
	Lights up when the audio device is playable by enabling the A2DP (Advanced Audio Distribution Profile).

To connect the last-connected device from this unit

Activate the BLUETOOTH function on the BLUETOOTH device.

Press SRC to select [BT PHONE] or [BT AUDIO].

Press ENTER to connect with the cellular phone, or PAUSE to connect with the audio device.

Note

While streaming BLUETOOTH audio, you cannot connect from this unit to the cellular phone. Connect from the cellular phone to this unit instead.

Tip

With BLUETOOTH signal on: when the ignition is turned to on, this unit reconnects automatically to the last-connected cellular phone.

Connecting with an iPhone/iPod (BLUETOOTH Auto Pairing)

When an iPhone/iPod with iOS5 or later installed is connected to the USB port, the unit is paired and connected with the iPhone/iPod automatically.

To enable BLUETOOTH Auto Pairing, make sure [AUTOPAIR] in [BT] is set to [ON] (page 23).

1 Activate the BLUETOOTH function on the iPhone/iPod.

2 Connect an iPhone/iPod to the USB port.

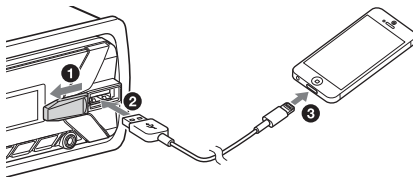

Make sure that  lights up on the display of the unit.

Notes

- BLUETOOTH Auto Pairing is not possible if the unit is already connected to another BLUETOOTH device. In this case, disconnect the other device, then connect the iPhone/iPod again.
- If BLUETOOTH Auto Pairing is not established, see "Preparing a BLUETOOTH Device" for details (page 9).

Connecting a USB Device

1 Turn down the volume on the unit.

2 Connect the USB device to the unit.

To connect an iPod/iPhone, use the USB connection cable for iPod (not supplied).

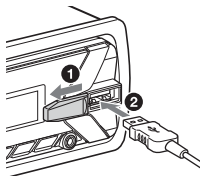

Connecting Other Portable Audio Device

- 1 Turn off the portable audio device.
- 2 Turn down the volume on the unit.
- 3 Connect the portable audio device to the AUX input jack (stereo mini jack) on the unit with a connecting cord (not supplied)*.

* Be sure to use a straight type plug.

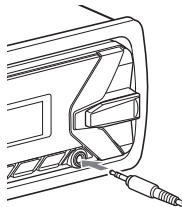

- 4 Press SRC to select [AUX].

To match the volume level of the connected device to other sources

Start playback of the portable audio device at a moderate volume, and set your usual listening volume on the unit.

Press MENU, then select [SET SOUND] → [SET AUX VOL] (page 22).

Listening to the Radio

Listening to the Radio

Tuning step setting is required (page 9).

To listen to the radio, press SRC to select [TUNER].

Storing automatically (BTM)

- 1 Press MODE to change the band (FM1, FM2, FM3, AM1 or AM2).
- 2 Press MENU, rotate the control dial to select [SET GENERAL], then press it.
- 3 Rotate the control dial to select [SET BTM], then press it.
The unit stores stations in order of frequency on the number buttons.

Tuning

- 1 Press MODE to change the band (FM1, FM2, FM3, AM1 or AM2).
- 2 Perform tuning.

To tune manually

Press and hold SEEK +/- to locate the approximate frequency, then press SEEK +/- repeatedly to fine adjust to the desired frequency.

To tune automatically

Press SEEK +/-.

Scanning stops when the unit receives a station.

Storing manually

- 1 While receiving the station that you want to store, press and hold a number button (1 to 6) until [MEM] appears.

Receiving the stored stations

- 1 Select the band, then press a number button (1 to 6).

Using Radio Data System (RDS)

Selecting program types (PTY)

- 1 Press PTY during FM reception.
- 2 Rotate the control dial until the desired program type appears, then press it.
The unit starts to search for a station broadcasting the selected program type.

Type of programs (tuner step: 200 kHz/10 kHz)

NEWS (News), **INFORM** (Information), **SPORTS** (Sports), **TALK** (Talk), **ROCK** (Rock), **CLS ROCK** (Classic Rock), **ADLT HIT** (Adult Hits), **SOFT RCK** (Soft Rock), **TOP 40** (Top 40), **COUNTRY** (Country), **OLDIES** (Oldies), **SOFT** (Soft), **NOSTALGA** (Nostalgia), **JAZZ** (Jazz), **CLASSICL** (Classical), **R & B** (Rhythm and Blues), **SOFT R&B** (Soft Rhythm and Blues), **LANGUAGE** (Foreign Language), **REL MUSC** (Religious Music), **REL TALK** (Religious Talk), **PERSNLTY** (Personality), **PUBLIC** (Public), **COLLEGE** (College), **HABL ESP** (Spanish Talk), **MUSC ESP** (Spanish Music), **HIP HOP** (Hip-Hop), **WEATHER** (Weather)

Type of programs (tuner step: 100 kHz/10 kHz, 50 kHz/9 kHz)

NEWS (News), **AFFAIRS** (Current Affairs), **INFO** (Information), **SPORT** (Sports), **EDUCATE** (Education), **DRAMA** (Drama), **CULTURE** (Culture), **SCIENCE** (Science), **VARIED** (Varied), **POP M** (Pop Music), **ROCK M** (Rock Music), **EASY M** (M.O.R. Music), **LIGHT M** (Light classical), **CLASSICS** (Serious classical), **OTHER M** (Other Music), **WEATHER** (Weather), **FINANCE** (Finance), **CHILDREN** (Children's program), **SOCIAL A** (Social Affairs), **RELIGION** (Religion), **PHONE IN** (Phone In), **TRAVEL** (Travel), **LEISURE** (Leisure), **JAZZ** (Jazz Music), **COUNTRY** (Country Music), **NATION M** (National Music), **OLDIES** (Oldies Music), **FOLK M** (Folk Music), **DOCUMENT** (Documentary)

Setting clock time (CT)

The CT data from the RDS transmission sets the clock.

- 1 Set [SET CT-ON] in [SET GENERAL] (page 21).

Listening to the SiriusXM Radio (US/Canada only)

Activating your SiriusXM Subscription

Only SiriusXM brings you more of what you love to listen to, all in one place. Get over 140 channels, including commercial-free music plus the best sports, news, talk, comedy and entertainment. Welcome to the world of satellite radio. A SiriusXM Connect Vehicle Tuner and Subscription are required. For more information, visit www.siriusxm.com

After installing your SiriusXM Connect Vehicle Tuner and antenna, press SRC to select [SIRIUSXM]. You should be able to hear the SiriusXM preview channel on Channel 1. After verifying that you can hear the preview channel, select Channel 0 to find

the Radio ID of your tuner. In addition, the Radio ID is located on the bottom of the SiriusXM Connect Vehicle Tuner and its packaging. You will need this number to activate your subscription. Write the number down for reference.

In the USA, you can activate online or by calling SiriusXM Listener Care:

- Online: Visit www.siriusxm.com/activatenow
- Phone: Call 1-866-635-2349

In Canada, you can activate online or by calling SiriusXM Listener Care:

- Online: Visit www.siriusxm.ca/activatexm
- Phone: Call 1-877-438-9677

As part of the activation process, the SiriusXM satellites will send an activation message to your tuner. When your radio detects that the tuner has received the activation message, your radio will display: [SUBSCRIPTION UPDATED - ENTER TO CONTINUE]. Once subscribed, you can tune to channels in your subscription plan.

Notes

- The activation process usually takes 10 to 15 minutes, but may take up to an hour.
- Your radio will need to be turned on and receiving the SiriusXM signal to receive the activation message.

Selecting channels for SiriusXM

- 1 Press **Q** (browse).
- 2 Rotate the control dial to select [CHANNEL], then press it.
- 3 Rotate the control dial to select the desired channel, then press it.

To select channels from categories

- 1 Press **Q** (browse).
- 2 Rotate the control dial to select [CATEGORY], then press it.
- 3 Rotate the control dial to select the desired category, then press it.

To store channels

- 1 While receiving the channel that you want to store, press and hold a number button (1 to 6) until [MEM] appears.

To receive the stored channel, press MODE to select [SX1], [SX2] or [SX3], then press a number button (1 to 6).

To set a parental control

The parental control feature allows you to limit access to SiriusXM channels with mature content. When enabled, the parental control feature requires you to enter a passcode to tune to the locked channels. Information on setting up the passcode and locking channels can be found below.

- 1 Press **MENU** and rotate the control dial.
- 2 Select [SET GENERAL] → [SET PARENTAL] → [SET LOCK SEL] → [SET LOCK-ON].
- 3 Enter the passcode by rotating the control dial on the unit or pressing **↑/↓** on the remote commander.
To move the entry position, press **SEEK +/-** on the unit or **←/→** on the remote commander.
The initial passcode is [0000].
- 4 After entering the passcode, press **ENTER**.

To unlock the channels, select [SET LOCK-OFF].

To change the passcode

- 1 Press **MENU** and rotate the control dial.
- 2 Select [SET GENERAL] → [SET PARENTAL] → [SET CODEEDIT].
- 3 Enter the current passcode on the current passcode input display, then press **ENTER**.
The initial passcode is [0000].
- 4 Enter your new 4-digit passcode on the new passcode input display, then press **ENTER**.

To change display items

Press **DSPL** to change as follows:

Channel Number (Default) → Channel Name → Artist Name → Song Title → Content Info → Category Name → Clock

Playback

Playing a USB Device

In these Operating Instructions, “iPod” is used as a general reference for the iPod functions on an iPod and iPhone, unless otherwise specified by the text or illustrations.

For details on the compatibility of your iPod, see “About iPod” (page 24) or visit the support site on the back cover.

MSC (Mass Storage Class) and MTP (Media Transfer Protocol) type USB devices (such as a USB flash drive, digital media player, Android smartphone) compliant with the USB standard can be used. Depending on the digital media player or Android smartphone, setting the USB connection mode to MTP is required.

Notes

- For details on the compatibility of your USB device, visit the support site on the back cover.
- Playback of the following files is not supported.
 - MP3/WMA/FLAC:
 - copyright-protected files
 - DRM (Digital Rights Management) files
 - Multi-channel audio files
 - MP3/WMA:
 - lossless compression files

1 Connect a USB device to the USB port (page 11).

Playback starts.

If a device is already connected, to start playback, press SRC to select [USB] ([IPD] appears in the display when the iPod is recognized).

2 Adjust the volume on this unit.

To stop playback

Press and hold OFF for 1 second.

To remove the device

Stop playback, then remove the device.

Caution for iPhone

When you connect an iPhone via USB, phone call volume is controlled by the iPhone, not the unit. Do not inadvertently increase the volume on the unit during a call, as a sudden loud sound may result when the call ends.

Operating an iPod directly (Passenger control)

1 During playback, press and hold MODE until [MODE IPOD] appears.

Operations of the iPod become available.

Note that the volume can be adjusted only by the unit.

To exit passenger control

Press and hold MODE until [MODE AUDIO] appears.

Playing a BLUETOOTH Device

You can play contents on a connected device that supports BLUETOOTH A2DP (Advanced Audio Distribution Profile).



1 Make BLUETOOTH connection with the audio device (page 10).

2 Press SRC to select [BT AUDIO].

3 Operate the audio device to start playback.

4 Adjust the volume on this unit.

Notes

- Depending on the audio device, information such as title, track number/time and playback status may not be displayed on this unit.
- Even if the source is changed on this unit, playback of the audio device does not stop.

To match the volume level of the BLUETOOTH device to other sources

Start playback of the BLUETOOTH audio device at a moderate volume, and set your usual listening volume on the unit.

Press MENU, then select [SET SOUND] → [SET BTA VOL.] (page 22).

Searching and Playing Tracks

Repeat play and shuffle play

- 1 During playback, press ◀ (repeat) or ↻ (shuffle) repeatedly to select the desired play mode.

Playback in the selected play mode may take time to start.

Available play modes differ depending on the selected sound source.

Searching a track by name (Quick-BrowZer™)

- 1 During USB playback, press Q (browse)* to display the list of search categories.

When the track list appears, press ⏪ (back) repeatedly to display the desired search category.

* During USB playback, press Q (browse) for more than 2 seconds to directly return to the beginning of the category list.

- 2 Rotate the control dial to select the desired search category, then press it to confirm.
- 3 Repeat step 2 to search the desired track. Playback starts.

To exit the Quick-BrowZer mode

Press Q (browse).

Searching by skipping items (Jump mode)

- 1 Press Q (browse).
- 2 Press SEEK +.
- 3 Rotate the control dial to select the item. The list is jumped in steps of 10% of the total number of items.
- 4 Press ENTER to return to the Quick-BrowZer mode. The selected item appears.
- 5 Rotate the control dial to select the desired item, then press it. Playback starts.

Listening to Pandora®

Pandora® is available to stream music through your iPhone and Android smartphone. You can control Pandora® on a USB-connected iPhone or BLUETOOTH-connected Android smartphone from this unit.

Pandora® is only available in certain countries.

Please visit

<http://www.pandora.com/legal>
for more information.

Setting up Pandora®

- 1 Check the compatibility of your mobile device by visiting the support site on the back cover.
- 2 Download the latest version of the Pandora® application from your smartphone's app store. A list of compatible devices can be found at www.pandora.com/everwhere/mobile

Streaming Pandora®

- 1 Connect this unit with the mobile device.
 - iPhone via USB (page 11)
 - Android smartphone via BLUETOOTH function (page 10)
- 2 Press SRC to select [PANDORA USB] or [BT PANDORA].
- 3 Launch Pandora® application on your mobile device.
- 4 Press PAUSE to start playback.

If the device number appears

Make sure that the same numbers are displayed (e.g., 123456) in this unit and the mobile device, then press ENTER on this unit and select [Yes] on the mobile device.

When activating the BLUETOOTH function

You can adjust the volume level.

Press MENU, then select [SET SOUND] → [SET BTA VOL.] (page 22).

Available Operations in Pandora®

"Thumbs" feedback

"Thumbs Up" or "Thumbs Down" feedback allows you to personalize stations.

- 1 During playback, press ▲ (Thumbs Up) or ▼ (Thumbs Down).

Using the station list

The station list allows you to easily select a desired station.

- 1 During playback, press Q (browse).
- 2 Press SEEK + to select the sorting order [BY DATE] or [A TO Z].
- 3 Rotate the control dial to select the desired station, then press it.
Playback starts.

Bookmarking

The track currently being played can be bookmarked and stored in your Pandora® account.

- 1 During playback, press MODE.

Handsfree Calling (via BLUETOOTH only)

To use a cellular phone, connect it with this unit. For details, see "Preparing a BLUETOOTH Device" (page 9).



Receiving a Call

- 1 Press **CALL** when a call is received with a ringtone.

The phone call starts.

Note

The ringtone and talker's voice are output only from the front speakers.

To reject the call

Press and hold **OFF** for 1 second.

To end the call

Press **CALL** again.

Making a Call

You can make a call from the phonebook or call history when a cellular phone supporting PBAP (Phone Book Access Profile) is connected.

From the phonebook

- 1 Press **CALL**, rotate the control dial to select [**PHONE BOOK**], then press it.
- 2 Rotate the control dial to select an initial from the initial list, then press it.
- 3 Rotate the control dial to select a name from the name list, then press it.

- 4 Rotate the control dial to select a number from the number list, then press it.

The phone call starts.

From the call history

- 1 Press **CALL**, rotate the control dial to select [**RECENT CALL**], then press it.
A list of the call history appears.
- 2 Rotate the control dial to select a name or phone number from the call history, then press it.
The phone call starts.

By phone number input

- 1 Press **CALL**, rotate the control dial to select [**DIAL NUMBER**], then press it.
 - 2 Rotate the control dial to enter the phone number, and lastly select [] (space), then press **ENTER***.
The phone call starts.
- * To move the digital indication, press **SEEK +/-**.

Note

[] appears instead of [#] on the display.

By redial

- 1 Press **CALL**, rotate the control dial to select [**REDIAL**], then press it.
The phone call starts.

By preset number

- 1 Press **SRC** to select [**BT PHONE**].
- 2 Press a number button (1 to 6) to select the contact you want to call.
- 3 Press **ENTER**.
The phone call starts.

Presetting phone numbers

You can store up to 6 contacts in the preset dial.

- 1** Select a phone number that you want to store in the preset dial, from the phonebook, call history or by inputting the phone number directly.
The phone number appears in the display of this unit.
- 2** Press and hold a number button (1 to 6) until [MEM] appears.
The contact is stored in the selected preset number.

By voice tags

You can make a call by saying the voice tag stored in a connected cellular phone that has a voice dialing function.

- 1** Press **CALL**, rotate the control dial to select **[VOICE DIAL]**, then press it.
Alternatively, press and hold **VOICE** for more than 2 seconds.
- 2** Say the voice tag stored on the cellular phone.
Your voice is recognized, and the call is made.

To cancel voice dialing

Press **VOICE**.

Available Operations during Call

To adjust the ringtone volume

Rotate the control dial while receiving a call.

To adjust the talker's voice volume

Rotate the control dial during a call.

To adjust the volume for the other party (Mic gain adjustment)

Press **MIC**.

Adjustable volume levels: [MIC-LOW], [MIC-MID], [MIC-HI].

To reduce echo and noise (Echo Canceler/ Noise Canceler Mode)

Press and hold **MIC**.

Settable mode: [EC/NC-1], [EC/NC-2].

To switch between handsfree mode and handheld mode

During a call, press **MODE** to switch the phone call audio between the unit and cellular phone.

Note

Depending on the cellular phone, this operation may not be available.

Useful Functions

Using Siri Eyes Free

Siri Eyes Free allows you to use an iPhone handsfree by simply speaking into the microphone. This function requires you to connect an iPhone to the unit via BLUETOOTH. Availability is limited iPhone 4s or later. Make sure that your iPhone is running the latest iOS version.

You must complete BLUETOOTH registration and connection configurations for the iPhone with the unit in advance. For details, see “Preparing a BLUETOOTH Device” (page 9).

1 Activate the Siri function on the iPhone.

For details, refer to the operating instructions supplied with the iPhone.

2 Press and hold VOICE for more than 2 seconds.

The voice command display appears.

3 After the iPhone beeps, speak into the microphone.

The iPhone beeps again, then Siri starts responding.

To deactivate Siri Eyes Free

Press VOICE.

Notes

- The iPhone may not recognize your voice depending on usage conditions. (For example, if you are in a moving boat.)
- Siri Eyes Free may not function properly, or the response time may lag in locations where iPhone signals are difficult to receive.
- Depending on the iPhone's operating condition, Siri Eyes Free may not function properly, or may quit.
- If you play a track with an iPhone using the BLUETOOTH audio connection, when the track starts playback via BLUETOOTH, Siri Eyes Free automatically quits and the unit switches to the BLUETOOTH audio source.
- When Siri Eyes Free is activated during audio playback, the unit may switch to the BLUETOOTH audio source even if you do not specify a track to play.
- When connecting the iPhone to the USB port, Siri Eyes Free may not function properly, or may quit.

- When connecting the iPhone to the unit via USB, do not activate Siri with the iPhone. Siri Eyes Free may not function properly, or may quit.
- There is no audio sound while Siri Eyes Free is activated.

Settings

Canceling the DEMO Mode

You can cancel the demonstration display which appears when the source is off and the clock is displayed.

- 1 Press **MENU**, rotate the control dial to select **[SET GENERAL]**, then press it.
- 2 Rotate the control dial to select **[SET DEMO]**, then press it.
- 3 Rotate the control dial to select **[SET DEMO-OFF]**, then press it.
The setting is complete.
- 4 Press **↶** (back) twice.
The display returns to normal reception/play mode.

Basic Setting Operation

You can set items in the following setup categories: General setup (GENERAL), Sound setup (SOUND), Display setup (DISPLAY), BLUETOOTH setup (BT) (Not available when the BT phone is selected.)

- 1 Press **MENU**.
- 2 Rotate the control dial to select the setup category, then press it.
The items that can be set differ depending on the source and settings.
- 3 Rotate the control dial to select the options, then press it.

To return to the previous display

Press **↶** (back).

General Setup (GENERAL)

DEMO (demonstration)

Activates the demonstration: [ON], [OFF].

CLOCK-ADJ (clock adjust) (page 9)

TUNER-STP (tuner step) (page 9)

(Available only while the source is off and the clock is displayed.)

CAUT ALM (caution alarm)

Activates the caution alarm: [ON], [OFF] (page 8).

(Available only while the source is off and the clock is displayed.)

BEEP

Activates the beep sound: [ON], [OFF].

AUTO OFF

Shuts off automatically after a desired time when the unit is turned off: [NO], [30S] (30 seconds), [30M] (30 minutes), [60M] (60 minutes).

CT (clock time)

Activates the CT function: [ON], [OFF].

BTM (best tuning memory) (page 12)

(Available only when the tuner is selected.)

PARENTAL

Sets the parental lock to [ON], [OFF], and edits the passcode (page 14).
(Available only when SiriusXM is selected.)

SXMRESET (SiriusXM reset)

Initializes the SiriusXM Connect Vehicle Tuner settings (preset channels/parental lock): [YES], [NO].
(Available only when SiriusXM is selected.)

Sound Setup (SOUND)

This setup menu is available when any source except for the BT phone is selected.

EQ5 PRESET

Selects an equalizer curve from 10 equalizer curves or off: [OFF], [R&B], [ROCK], [POP], [DANCE], [HIP-HOP], [ELECTRONICA], [JAZZ], [SOUL], [COUNTRY], [CUSTOM].

The equalizer curve setting can be memorized for each source.

EQ5 SETTING

Sets [CUSTOM] of EQ5.

BASE

Selects a preset equalizer curve as a basis for further customizing: [BAND1] (low frequency), [BAND2] (mid-low frequency), [BAND3] (mid frequency), [BAND4] (mid-high frequency), [BAND5] (high frequency).

The volume level is adjustable in 1 dB steps, from -10 dB to +10 dB.

BALANCE

Adjusts the sound balance: [RIGHT-15] – [CENTER] – [LEFT-15].

FADER

Adjusts the relative level: [FRONT-15] – [CENTER] – [REAR-15].

S.WOOFER (subwoofer)

SW LEVEL (subwoofer level)

Adjusts the subwoofer volume level:

[+6 dB] – [0 dB] – [-6 dB], [ATT].

([ATT] is displayed at the lowest setting.)

SW PHASE (subwoofer phase)

Selects the subwoofer phase: [NORM], [REV].

LPF FREQ (low pass filter frequency)

Selects the subwoofer cut-off frequency: [80Hz], [100Hz], [120Hz].

AUX VOL (AUX volume level)

Adjusts the volume level for each connected auxiliary device: [+18 dB] – [0 dB] – [-8 dB].

This setting negates the need to adjust the volume level between sources.

BTA VOL (BLUETOOTH audio volume level)

Adjusts the volume level for each connected BLUETOOTH device: [+6 dB] – [0 dB] – [-6 dB].

This setting negates the need to adjust the volume level between sources.

Display Setup (DISPLAY)

DIMMER

Changes the display brightness: [ON], [OFF].

SND SYNC (sound synchronization)

Activates the synchronization of the illumination with the sound: [ON], [OFF].

AUTO SCR (auto scroll)

Scrolls long items automatically: [ON], [OFF].

(Not available when the AUX or tuner is selected.)

BLUETOOTH Setup (BT)

PAIRING (page 10)

PHONE BOOK (page 18)

REDIAL (page 18)

RECENT CALL (page 18)

VOICE DIAL (page 19)

DIAL NUMBER (page 18)

RINGTONES

Selects whether this unit or the connected cellular phone outputs the ringtone: [1] (this unit), [2] (cellular phone).

AUTO ANS (auto answer)

Sets this unit to answer an incoming call automatically: [OFF], [1] (about 3 seconds), [2] (about 10 seconds).

AUTOPAIR (auto pairing)

Start BLUETOOTH pairing automatically when iOS device version 5.0 or later is connected via USB: [ON], [OFF].

BT SIGNAL (BLUETOOTH signal) (page 10)

Activates/deactivates the BLUETOOTH function.

BT INIT (BLUETOOTH initialize)

Initializes all the BLUETOOTH related settings (pairing information, preset number, device information, etc.): [YES], [NO].

When disposing the unit, initialize all the settings.

(Available only while the source is off and the clock is displayed.)

Additional Information

Precautions

- Cool off the unit beforehand if your boat has been moored in direct sunlight.
- Do not leave the front panel or audio devices brought in inside the boat, or it may cause malfunction due to high temperature in direct sunlight.
- Power antenna (aerial) extends automatically.

To maintain high sound quality

Do not splash liquid onto the unit.

Playback order of audio files

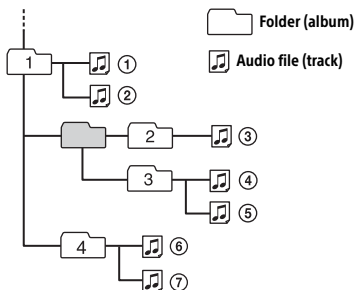

About iPod

- You can connect to the following iPod models. Update your iPod devices to the latest software before use.

Compatible iPhone/iPod models

Compatible Model	USB
iPhone 6 Plus	○
iPhone 6	○
iPhone 5s	○
iPhone 5c	○
iPhone 5	○
iPhone 4s	○
iPhone 4	○
iPhone 3GS	○
iPod touch (5th generation)	○
iPod touch (4th generation)	○
iPod touch (3rd generation)	○
iPod classic	○
iPod nano (7th generation)	○
iPod nano (6th generation)	○
iPod nano (5th generation)	○

- “Made for iPod,” and “Made for iPhone,” mean that an electronic accessory has been designed to connect specifically to iPod or iPhone, respectively, and has been certified by the developer to meet Apple performance standards. Apple is not responsible for the operation of this device or its compliance with safety and regulatory standards. Please note that the use of this accessory with iPod or iPhone may affect wireless performance.

If you have any questions or problems concerning your unit that are not covered in this manual, consult your nearest Sony dealer.

Maintenance

Replacing the lithium battery of the remote commander

Under normal conditions, the battery will last approximately 1 year. (The service life may be shorter, depending on the conditions of use.) When the battery becomes weak, the range of the remote commander becomes shorter.

CAUTION

Danger of explosion if battery is incorrectly replaced. Replaced only with the same or equivalent type.

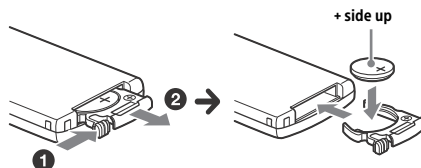

Notes on the lithium battery

- Keep the lithium battery out of the reach of children. Should the battery be swallowed, immediately consult a doctor.
- Wipe the battery with a dry cloth to ensure a good contact.
- Be sure to observe the correct polarity when installing the battery.
- Do not hold the battery with metallic tweezers, otherwise a short-circuit may occur.

Cleaning the connectors

The unit may not function properly if the connectors between the unit and the front panel are not clean. In order to prevent this, detach the front panel (page 8) and clean the connectors with a cotton swab. Do not apply too much force. Otherwise, the connectors may be damaged.

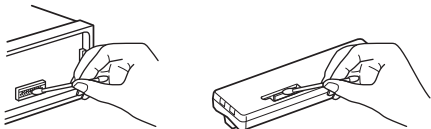

Notes

- For safety, turn off the ignition before cleaning the connectors, and remove the key from the ignition switch.
- Never touch the connectors directly with your fingers or with any metal device.

Specifications

FOR THE CUSTOMERS IN THE USA. NOT APPLICABLE IN CANADA, INCLUDING IN THE PROVINCE OF QUEBEC.

POUR LES CLIENTS AUX ÉTATS-UNIS. NON APPLICABLE AU CANADA, Y COMPRIS LA PROVINCE DE QUÉBEC.

AUDIO POWER SPECIFICATIONS



CEA2006 Standard
 Power Output: 17 Watts RMS x 4 at 4 Ohms < 1% THD+N
 SN Ratio: 80 dBA
 (reference: 1 Watt into 4 Ohms)

Tuner section

FM

Tuning range:

87.5 – 108.0 MHz (at 50 kHz step)

87.5 – 108.0 MHz (at 100 kHz step)

87.5 – 107.9 MHz (at 200 kHz step)

FM tuning step:

50 kHz/100 kHz/200 kHz switchable

Antenna (aerial) terminal:

External antenna (aerial) connector

Intermediate frequency:

FM CCIR: -1,956.5 to -487.3 kHz and
 +500.0 to +2,095.4 kHz

Usable sensitivity: 7 dBf

Selectivity: 75 dB at 400 kHz

Signal-to-noise ratio: 73 dB

Separation: 50 dB at 1 kHz

Frequency response: 20 – 15,000 Hz

AM

Tuning range:

531 – 1,602 kHz (at 9 kHz step)

530 – 1,710 kHz (at 10 kHz step)

AM tuning step:

9 kHz/10 kHz switchable

Antenna (aerial) terminal:

External antenna (aerial) connector

Sensitivity: 26 µV

USB Player section

Interface: USB (Full-speed)

Maximum current: 1 A

The maximum number of recognizable tracks:

– folders (albums): 256

– files (tracks) per folder: 256

Corresponding codec:

MP3 (.mp3)

Bit rate: 8 – 320 kbps (Supports VBR (Variable Bit Rate))

Sampling rate: 16 – 48 kHz

WMA (.wma)

Bit rate: 32 – 192 kbps (Supports VBR (Variable Bit Rate))

Sampling rate: 32 kHz, 44.1 kHz, 48 kHz

FLAC (.flac)

Bit depth: 16 bit, 24 bit

Sampling rate: 44.1 kHz, 48 kHz

Wireless Communication

Communication System:

BLUETOOTH Standard version 3.0

Output:

BLUETOOTH Standard Power Class 2
 (Max. +4 dBm)

Maximum communication range*1:

Line of sight approx. 10 m (33 ft)

Frequency band:

2.4 GHz band (2.4000 – 2.4835 GHz)

Modulation method: FHSS

Compatible BLUETOOTH Profiles*2:

A2DP (Advanced Audio Distribution Profile) 1.3

AVRCP (Audio Video Remote Control Profile) 1.3

HFP (Handsfree Profile) 1.6

PBAP (Phone Book Access Profile)

Corresponding codec:

SBC (.sbc)

*1 The actual range will vary depending on factors such as obstacles between devices, magnetic fields around a microwave oven, static electricity, reception sensitivity, antenna (aerial)'s performance, operating system, software application, etc.

*2 BLUETOOTH standard profiles indicate the purpose of BLUETOOTH communication between devices.

Power amplifier section

Output: Speaker outputs

Speaker impedance: 4 – 8 ohms

Maximum power output: 55 W × 4 (at 4 ohms)

General

Outputs:

Audio outputs terminal (REAR, SUB)

Power antenna (aerial)/Power amplifier control terminal (REM OUT)

Inputs:

SiriusXM input terminal (US/Canada only)

Remote controller input terminal

Antenna (aerial) input terminal

AUX input jack (stereo mini jack)

USB port

Power requirements: 12 V DC boat battery (negative ground (earth))

Rated current consumption: 10 A

Dimensions:

Approx. 178 mm × 50 mm × 120 mm
(7 1/8 in × 2 in × 4 3/4 in) (w/h/d)

Mounting dimensions:

Approx. 182 mm × 53 mm × 102 mm
(7 1/4 in × 2 1/8 in × 4 1/8 in) (w/h/d)

Mass: Approx. 0.7 kg (1 lb 9 oz)

Package contents:

Main unit (1)

Remote commander (1): RM-X231

Parts for installation and connections (1 set)

Optional accessories/equipment*:

SiriusXM Connect Vehicle Tuner: SXV100

Marine remote commander: RM-X11M

* Accessories/equipment other than the marine remote commander RM-X11M are not waterproof. Do not subject them to water.

Your dealer may not handle some of the above listed accessories. Please ask the dealer for detailed information.

Design and specifications are subject to change without notice.

Copyrights



SiriusXM Connect Vehicle Tuner and Subscription sold separately.

www.siriusxm.com

Sirius, XM and all related marks and logos are trademarks of Sirius XM Radio Inc. All rights reserved.

The Bluetooth® word mark and logos are registered trademarks owned by Bluetooth SIG, Inc. and any use of such marks by Sony Corporation is under license. Other trademarks and trade names are those of their respective owners.

The N-Mark is a trademark or registered trademark of NFC Forum, Inc. in the United States and in other countries.

Windows Media is either a registered trademark or trademark of Microsoft Corporation in the United States and/or other countries.

This product is protected by certain intellectual property rights of Microsoft Corporation. Use or distribution of such technology outside of this product is prohibited without a license from Microsoft or an authorized Microsoft subsidiary.

iPhone, iPod, iPod classic, iPod nano, iPod touch, and Siri are trademarks of Apple Inc., registered in the U.S. and other countries.

MPEG Layer-3 audio coding technology and patents licensed from Fraunhofer IIS and Thomson.

Pandora®, the Pandora® logo, and the Pandora® trade dress are trademarks or registered trademarks of Pandora Media, Inc., used with permission.

Google, Google Play and Android are trademarks of Google Inc.

libFLAC

Copyright (C) 2000-2009 Josh Coalson
Copyright (C) 2011-2013 Xiph.Org Foundation

Redistribution and use in source and binary forms, with or without modification, are permitted provided that the following conditions are met:

- Redistributions of source code must retain the above copyright notice, this list of conditions and the following disclaimer.
- Redistributions in binary form must reproduce the above copyright notice, this list of conditions and the following disclaimer in the documentation and/or other materials provided with the distribution.
- Neither the name of the Xiph.org Foundation nor the names of its contributors may be used to endorse or promote products derived from this software without specific prior written permission.

THIS SOFTWARE IS PROVIDED BY THE COPYRIGHT HOLDERS AND CONTRIBUTORS "AS IS" AND ANY EXPRESS OR IMPLIED WARRANTIES, INCLUDING, BUT NOT LIMITED TO, THE IMPLIED WARRANTIES OF MERCHANTABILITY AND FITNESS FOR A PARTICULAR PURPOSE ARE DISCLAIMED. IN NO EVENT SHALL THE FOUNDATION OR CONTRIBUTORS BE LIABLE FOR ANY DIRECT, INDIRECT, INCIDENTAL, SPECIAL, EXEMPLARY, OR CONSEQUENTIAL DAMAGES (INCLUDING, BUT NOT LIMITED TO, PROCUREMENT OF SUBSTITUTE GOODS OR SERVICES; LOSS OF USE, DATA, OR PROFITS; OR BUSINESS INTERRUPTION) HOWEVER CAUSED AND ON ANY THEORY OF LIABILITY, WHETHER IN CONTRACT, STRICT LIABILITY, OR TORT (INCLUDING NEGLIGENCE OR OTHERWISE) ARISING IN ANY WAY OUT OF THE USE OF THIS SOFTWARE, EVEN IF ADVISED OF THE POSSIBILITY OF SUCH DAMAGE.

Troubleshooting

The following checklist will help you remedy problems you may encounter with your unit. Before going through the checklist below, check the connection and operating procedures.

For details on using the fuse and removing the unit from the dashboard, see "Connection/Installation" (page 33).

If the problem is not solved, visit the support site on the back cover.

General

No power is being supplied to the unit.

- If the unit is turned off and the display disappears, the unit cannot be operated with the remote commander.
 - Turn on the unit.

No sound or the sound is very low.

- The position of the fader control [FADER] is not set for a 2-speaker system.
- The volume of the unit and/or connected device is very low.
 - Increase the volume of the unit and connected device.

No beep sound.

- An optional power amplifier is connected and you are not using the built-in amplifier.

The contents of the memory have been erased.

- The power supply lead or battery has been disconnected or not connected properly.

Stored stations and correct time are erased.

The fuse has blown.

Makes a noise when the position of the ignition is switched.

- The leads are not matched correctly with the boat's accessory power connector.

During playback or reception, the demonstration mode starts.

- If no operation is performed for 5 minutes with [DEMO-ON] set, the demonstration mode starts.
 - Set [DEMO-OFF] (page 21).

The display disappears from/does not appear in the display window.

- The dimmer is set to [DIM-ON] (page 22).
- The display disappears if you press and hold OFF.
 - Press OFF on the unit until the display appears.
- The connectors are dirty (page 24).

The display/illumination flashes.

- The power supply is not sufficient.
 - Check that the boat battery supplies enough power to the unit. (The power requirement is 12 V DC.)

The operation buttons do not function.

- The connection is not correct.
 - Check the connection of the unit.
 - If the situation does not improve, press DSPL and  (back)/MODE for more than 2 seconds to reset the unit.
 - The contents stored in memory are erased.
 - For your safety, do not reset the unit while you are driving.

Radio reception**Stations cannot be received.****The sound is hampered by noises.**

- The connection is not correct.
 - If your boat has built-in radio antenna (aerial) in the rear/side glass, connect an REM OUT lead (blue/white striped) or accessory power supply lead (red) to the power supply lead of a boat's antenna (aerial) booster.
 - Check the connection of the boat antenna (aerial).
 - If the auto antenna (aerial) will not extend, check the connection of the power antenna (aerial) control lead.
- The tuning step setting has been erased.
 - Set the tuning step again (page 9).

Preset tuning is not possible.

- The broadcast signal is too weak.

RDS**PTY displays [- - - - -].**

- The current station is not an RDS station.
- RDS data has not been received.
- The station does not specify the program type.

USB device playback**You cannot play items via a USB hub.**

- This unit cannot recognize USB devices via a USB hub.

A USB device takes longer to play.

- The USB device contains files with a complicated tree structure.

The sound is intermittent.

- The sound may be intermittent at a high-bit-rate.
- DRM (Digital Rights Management) files may not be playable in some cases.

Audio file cannot be played.

- USB device formatted with file systems other than FAT16 or FAT32 are unsupported.*

* This unit supports FAT16 and FAT32, but some USB device may not support all of these FAT. For details, refer to the operating instruction of each USB device or contact the manufacturer.

NFC function**One touch connection (NFC) is not possible.**

- If the smartphone does not respond to the touching.
 - Check that the NFC function of the smartphone is turned on.
 - Move the N-Mark part of the smartphone closer to the N-Mark part on this unit.
 - If the smartphone is in a case, remove it.
- NFC receiving sensitivity depends on the device. If One touch connection with the smartphone fails several times, make BLUETOOTH connection manually.

BLUETOOTH function

The connecting device cannot detect this unit.

- Before the pairing is made, set this unit to pairing standby mode.
- While connected to a BLUETOOTH device, this unit cannot be detected from another device.
 - Disconnect the current connection and search for this unit from another device.
- When the device pairing is made, set the BLUETOOTH signal output to on (page 10).

Connection is not possible.

- The connection is controlled from one side (this unit or BLUETOOTH device), but not both.
 - Connect to this unit from a BLUETOOTH device or vice versa.

The name of the detected device does not appear.

- Depending on the status of the other device, it may not be possible to obtain the name.

No ringtone.

- Adjust the volume by rotating the control dial while receiving a call.
- Depending on the connecting device, the ringtone may not be sent properly.
 - Set [RINGTONE] to [1] (page 22).
- The front speakers are not connected to the unit.
 - Connect the front speakers to the unit. The ringtone is output only from the front speakers.

The talker's voice cannot be heard.

- The front speakers are not connected to the unit.
 - Connect the front speakers to the unit. The talker's voice is output only from the front speakers.

A call partner says that the volume is too low or high.

- Adjust the volume accordingly using mic gain adjustment (page 19).

Echo or noise occurs in phone call conversations.

- Lower the volume.
- Set EC/NC Mode to [EC/NC-1] or [EC/NC-2] (page 19).
- If the ambient noise other than the phone call sound is loud, try reducing this noise.
E.g.: If a window is open and outside noise, etc., is loud, shut the window. If an air conditioner is loud, lower the air conditioner.

The phone is not connected.

- When BLUETOOTH audio is played, the phone is not connected even if you press CALL.
 - Connect from the phone.

The phone sound quality is poor.

- Phone sound quality depends on reception conditions of cellular phone.
 - Move your boat to a place where you can enhance the cellular phone's signal if the reception is poor.

The volume of the connected audio device is low (high).

- Volume level will differ depending on the audio device.
 - Adjust the volume of the connected audio device or this unit.

The sound skips during playback of a BLUETOOTH audio device.

- Reduce the distance between the unit and the BLUETOOTH audio device.
- If the BLUETOOTH audio device is stored in a case which interrupts the signal, remove the audio device from the case during use.
- Several BLUETOOTH devices or other devices which emit radio waves are in use nearby.
 - Turn off the other devices.
 - Increase the distance from the other devices.
- The playback sound stops momentarily when the connection between this unit and the cellular phone is being made. This is not a malfunction.

The connected BLUETOOTH audio device cannot be controlled.

- Check that the connected BLUETOOTH audio device supports AVRCP.

Some functions do not work.

- Check if the connecting device supports the functions in question.

A call is answered unintentionally.

- The connecting phone is set to answer a call automatically.

Pairing failed due to a timeout.

- Depending on the connecting device, the time limit for pairing may be short.
 - Try completing the pairing within the time.

BLUETOOTH function cannot operate.

- Turn off the unit by pressing OFF for more than 2 seconds, then turn the unit on again.

No sound is output from the boat's speakers during handsfree call.

- If the sound is output from the cellular phone, set the cellular phone to output the sound from the boat's speakers.

Siri Eyes Free is not activated.

- Perform the handsfree registration for an iPhone that supports Siri Eyes Free.
- Set the Siri function on the iPhone to on.
- Cancel the BLUETOOTH connection with the iPhone and the unit, and reconnect.

Pandora® operation

Pandora® connection is not possible.

- Shut down the Pandora® application on the mobile device, and then launch it again.

Error displays/Messages

HUB NO SUPRT: USB hubs are not supported.

IPD STOP: iPod playback has finished.

- Operate your iPod/iPhone to start playback.

NO DEV: A USB device is not connected or recognized.

- Make sure the USB device or USB cable is securely connected.

OVERLOAD: The USB device is overloaded.

- Disconnect the USB device, then press SRC to select another source.
- The USB device has a fault, or an unsupported device is connected.

READ: Now reading information.

- Wait until reading is complete and playback starts automatically. This may take some time depending on the file organization.

USB ERROR: The USB device cannot be played.

- Connect the USB device again.

USB NO MUSIC: There is no playable file.

- Connect a USB device containing playable files (page 25).

USB NO SUPRT: The USB device is not supported.

- For details on the compatibility of your USB device, visit the support site on the back cover.

For BLUETOOTH function:

ERROR: The selected operation could not be performed.

- Wait for a while, then try again.

NO DEV: The BLUETOOTH device is not connected or recognized.

- Make sure the BLUETOOTH device is securely connected, or the BLUETOOTH connection is established with the BLUETOOTH device.

P EMPTY: No phone numbers are stored.

UNKNOWN: A name or phone number cannot be displayed.

WITHHELD: The phone number is hidden by the caller.

For Pandora® operation:

CANNOT SKIP: Skipping tracks is not allowed.

- Wait until the commercial ends, next track begins, or select another station on the list. Pandora® limits the number of skips allowed on their service.
-

NO NETWORK: The network connection is unstable or lost.

- Make the network connection again on the device, or wait until the network connection is established.
-

NO STATION - PLEASE - CREATE - STATION - IN - PANDORA APP: No stations on your account.

- Create the station on the mobile device.
-

NOT ALLOWED: The selected operation is not allowed.

- “Thumbs” feedback is not allowed.
 - Wait until the commercial ends.
 - Some functions, such as Shared Station, do not permit feedback. Wait until the next track begins, or select another station on the list.
 - Bookmark is not allowed.
 - Wait until the commercial ends.
 - Select another track or station, then try it again.
-

PAN ERROR: The selected operation could not be performed.

- Wait for a while, then try again.
-

PAN MAINT: The Pandora® server is under maintenance.

- Wait for a while, then try again.
-

PAN NO SUPRT: The connected device is not supported.

- For details of compatible devices, visit the support site.
-

PAN OPEN APP: Pandora® is not running when connecting via the USB port.

- Launch the Pandora® application on the iPhone.
-

PAN OPEN APP - PRESS PAUSE: Pandora® is not running when connecting via the BLUETOOTH function.

- Launch the Pandora® application on the mobile device, then press PAUSE.
-

PAN RESTRICT: Pandora® is not available outside your country.

PLEASE LOGIN - PANDORA APP: You are not logged into your Pandora® account.

- Disconnect the device, log into your Pandora® account, then connect the device again.
-

UPDATE PAN: An old version of Pandora® is connected.

- Update the Pandora® application to the latest version.
-

For SiriusXM operation:

CH LOCKED

- The channel that you have requested is locked by the radio parental control feature. See “To set a parental control” (page 14) for more information on the parental control feature and how to access locked channels.
-

CH UNAVAIL

- The channel that you have requested is not a valid SiriusXM channel or the channel that you were listening to is no longer available.
 - You may also see this message briefly when first connecting a new SiriusXM Connect Vehicle Tuner. Visit www.siriusxm.com in the USA or www.siriusxm.ca in Canada for SiriusXM channel lineup information.
-

CHAN UNSUB

→ The channel that you have requested is not included in your SiriusXM subscription package or the channel that you were listening to is no longer included in your SiriusXM subscription package.

If you have questions about your subscription package or would like to subscribe to this channel, please contact SiriusXM.

In the USA, visit www.siriusxm.com or call 1-866-635-2349.

In Canada, visit www.siriusxm.ca or call 1-877-438-9677.

CHK ANT

→ The radio has detected a fault with the SiriusXM antenna.

→ The antenna cable may be either disconnected or damaged.

– Verify that the antenna cable is connected to the SiriusXM Connect Vehicle Tuner.

– Inspect the antenna cable for damage and kinks.

– Replace the antenna if the cable is damaged. SiriusXM products are available at your local boat audio retailer or online at - www.shop.siriusxm.com

CHECK TUNER

→ The radio is having difficulty communicating with the SiriusXM Connect Vehicle Tuner.

→ The tuner may be disconnected or damaged.

– Verify that the SiriusXM Connect Vehicle Tuner cable is securely connected to the radio.

NO SIGNAL

→ SiriusXM Connect Vehicle Tuner is having difficulty receiving the SiriusXM satellite signal.

– Verify that your boat is outdoors with a clear view of the sky.

– Verify that the SiriusXM magnetic mount antenna is mounted on a metal surface on the outside of the boat.

– Move the SiriusXM antenna away from any obstructions.

– Inspect the antenna cable for damage and kinks.

– Consult the SiriusXM Connect Vehicle Tuner installation manual for more information on antenna installation.

– Replace the antenna if the cable is damaged. SiriusXM products are available at your local boat audio retailer or online at - www.shop.siriusxm.com

SUBSCRIPTION UPDATE - ENTER TO CONTINUE

→ The radio has detected a change in your SiriusXM subscription status.

– Press ENTER to clear the message.

If you have questions about your subscription, please contact SiriusXM.

In the USA, visit www.siriusxm.com or call 1-866-635-2349.

In Canada, visit www.siriusxm.ca or call 1-877-438-9677.

If these solutions do not help improve the situation, consult your nearest Sony dealer.

Connection/Installation

Cautions

- Run all ground (earth) leads to a common ground (earth) point.
- Do not get the leads trapped under a screw, or caught in moving parts (e.g., seat railing).
- Before making connections, turn the boat's ignition off to avoid short circuits.
- Connect the **yellow** and **red** power supply leads only after all other leads have been connected.
- Be sure to insulate any loose unconnected leads with electrical tape for safety.

Precautions

- Choose the installation location carefully so that the unit will not interfere with normal boating or car driving operations.
- Avoid installing the unit in areas subject to dust, dirt, excessive vibration, or high temperature, such as in direct sunlight or near heater ducts.
- Select carefully the mounting location to avoid internal damage by water entering the unit. Areas subject to water splashes should be avoided. The Waterproof Car Stereo Cover (not supplied) is recommended.
- Use only the supplied mounting hardware for a safe and secure installation.

Note on the power supply lead (yellow)

When connecting this unit in combination with other stereo components, the amperage rating of the boat circuit to which the unit is connected must be higher than the sum of each component's fuse amperage rating.

Mounting angle adjustment

Adjust the mounting angle to less than 45°.

Parts List for Installation

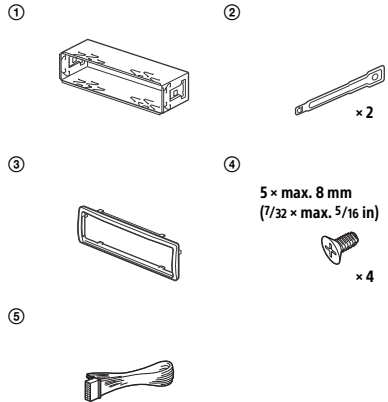

- This parts list does not include all the package contents.
- The bracket ① and the protection collar ③ are attached to the unit before shipping. Before mounting the unit, use the release keys ② to remove the bracket ① from the unit. For details, see "Removing the protection collar and the bracket" (page 36).
- Keep the release keys ② for future use as they are also necessary if you remove the unit from your boat.

Connection

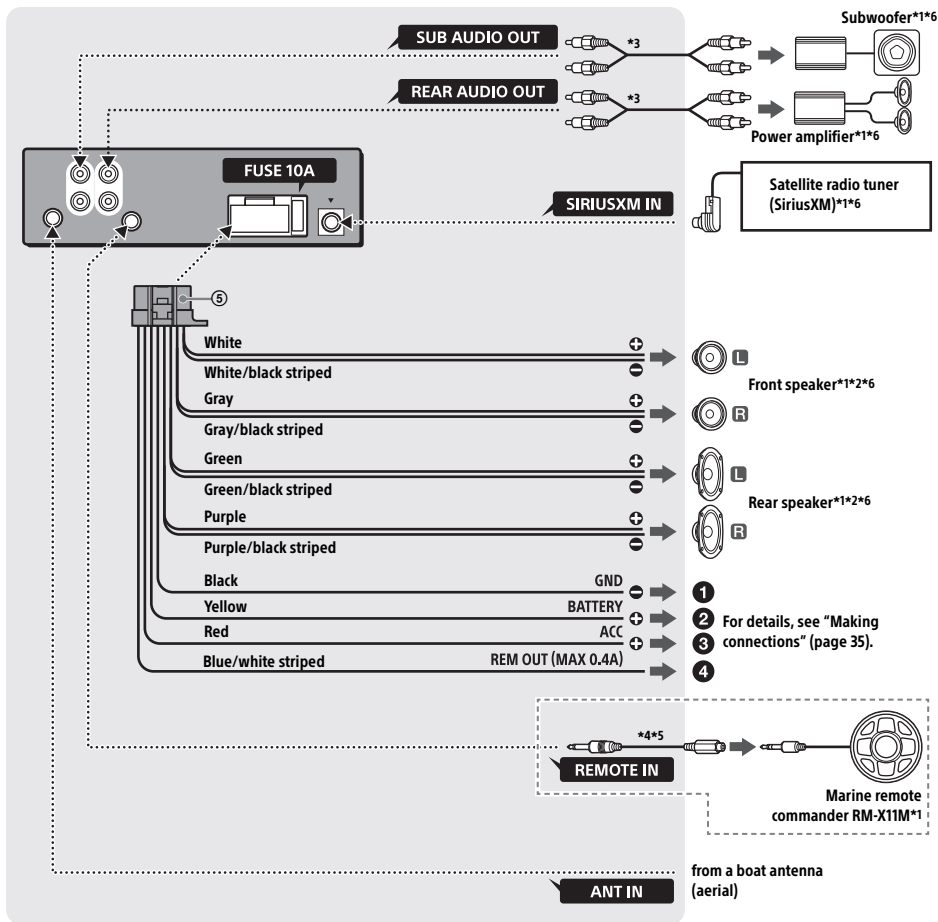

*1 Not supplied

*2 Speaker impedance: 4 – 8 Ω × 4

*3 RCA pin cord (not supplied)

*4 Depending on the type of boat, use an adaptor for a wired remote control (not supplied).

*5 Supplied with the marine remote commander.

*6 Not waterproof

Making connections

- 1 To battery or distribution block ground**
First connect the black ground (earth) lead, then connect the yellow and red power supply leads.
- 2 To the +12 V power terminal which is energized at all times**
Be sure to connect the black ground (earth) lead to the battery or distribution block ground first.
- 3 To the +12 V power terminal which is energized when the ignition switch is set to the accessory position**
If there is no accessory position, connect to the +12 V power (battery) terminal which is energized at all times.
Be sure to connect the black ground (earth) lead to the battery or distribution block ground first.
- 4 To the power antenna (aerial) control lead or the power supply lead of the antenna (aerial) booster**
It is not necessary to connect this lead if there is no power antenna (aerial) or antenna (aerial) booster, or with a manually-operated telescopic antenna (aerial).
To AMP REMOTE IN of an optional power amplifier
This connection is only for amplifiers and a power antenna (aerial). Connecting any other system may damage the unit.

Subwoofer Easy Connection

You can use a subwoofer without a power amplifier when it is connected to a rear speaker cord.

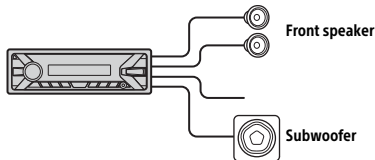

Note

Use a subwoofer with an impedance of 4 to 8 ohms, and with adequate power handling capacities to avoid damage.

Memory hold connection

When the yellow power supply lead is connected, power will always be supplied to the memory circuit even when the ignition switch is turned off.

Speaker connection

- Before connecting the speakers, turn the unit off.
- Use speakers with an impedance of 4 to 8 ohms, and with adequate power handling capacities to avoid damage.

Installation

Removing the protection collar and the bracket

Before installing the unit, remove the protection collar ③ and the bracket ① from the unit.

- 1 Pinch both edges of the protection collar ③, then pull it out.

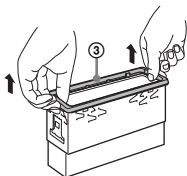

- 2 Insert both release keys ② until they click, and pull down the bracket ①, then pull up the unit to separate.

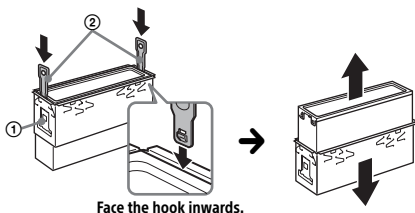

Mounting the unit in the dashboard or the cutout hole on boat

- Before installing, make sure the catches on both sides of the bracket ① are bent inwards 2 mm (3/32 in).
- For Japanese cars, see "Mounting the unit in a Japanese car" (page 37).

- 1 Position the bracket ① inside the dashboard, then bend the claws outward for a tight fit.

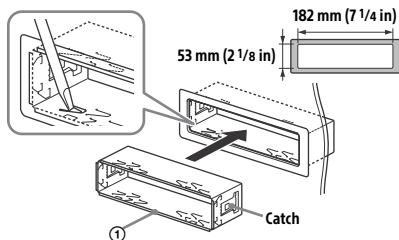

- 2 Mount the unit onto the bracket ①, then attach the protection collar ③.

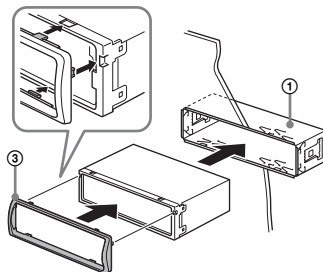

Notes

- If the catches are straight or bent outwards, the unit will not be installed securely and may spring out.
- Make sure the 4 catches on the protection collar ③ are properly engaged in the slots of the unit.

Mounting the unit in a Japanese car

You may not be able to install this unit in some makes of Japanese cars. In such a case, consult your Sony dealer.

TOYOTA

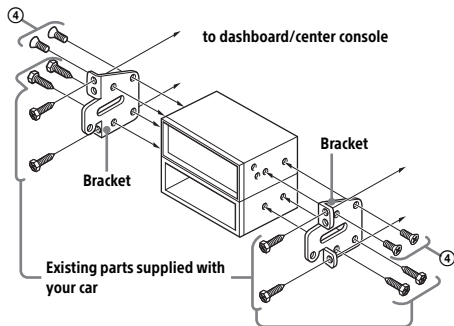

NISSAN

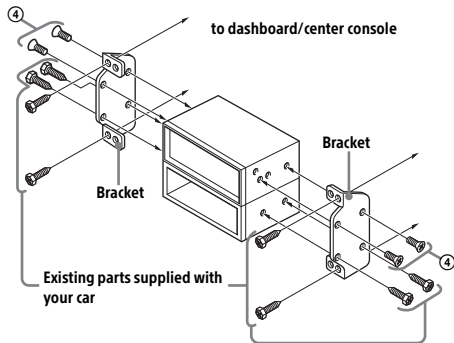

Note

To prevent malfunction, install only with the supplied screws (4).

Fuse replacement

When replacing the fuse, be sure to use one matching the amperage rating stated on the original fuse. If the fuse blows, check the power connection and replace the fuse. If the fuse blows again after replacement, there may be an internal malfunction. In such a case, consult your nearest Sony dealer.

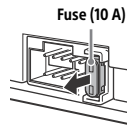

Detaching and attaching the front panel

For details, see "Detaching the Front Panel" (page 8).

SONY®

LIMITED WARRANTY Car Audio (U.S. Only)

Sony Electronics Inc. ("Sony") warrants this product against defects in material or workmanship for the time periods and as set forth below when purchased directly from Sony or a Sony Retailer. Pursuant to this Limited Warranty, Sony will, at its option, (i) repair the product using new or refurbished parts or (ii) replace the product with a new or refurbished product. For purposes of this Limited Warranty, "refurbished" means a product or part that has been returned to its original specifications. **In the event of a defect, these are your exclusive remedies.**

Labor: For a period of one (1) year from the original date of purchase of the product ("Labor Warranty"), Sony will, at its option, repair or replace with new or refurbished product, product determined to be defective. If Sony elects to replace the product after this Labor Warranty has expired but while the Parts Warranty below is still in effect, it will do so for the applicable labor charge.

Parts: For a period of one (1) year from the original date of purchase of product ("Parts Warranty"), Sony will supply new or refurbished replacement parts in exchange for parts determined to be defective.

This Limited Warranty covers only the hardware components packaged with the Product. It does not cover technical assistance for hardware or software usage and it does not cover any software products whether or not contained in the Product; any such software is provided "AS IS" unless expressly provided for in any enclosed software Limited Warranty. Please refer to the End User License Agreements included with the Product for your rights and obligations with respect to the software.

Instructions: To obtain warranty service, you must deliver the product, freight prepaid, in either its original packaging or packaging affording an equal degree of protection to the Sony authorized service facility specified. **It is your responsibility to backup any data, software or other materials you may have stored or preserved on your unit. It is likely that such data, software, or other materials will be lost or reformatted during service and Sony will not be responsible for any such damage or loss.** A dated purchase receipt from Sony or a Sony Retailer is required. For specific instructions on how to obtain warranty service for your product,

Visit Sony's Web Site:
www.sony.com/support

Or call the **Sony Customer Information Service Center**
1-800-222-SONY(7669)

For an accessory or part not available from your authorized dealer, call:

1-800-488-SONY (7669)

Repair / Replacement Warranty: This Limited Warranty shall apply to any repair, replacement part or replacement product for the remainder of the original Limited Warranty period or for ninety (90) days, whichever is longer. Any parts or product replaced under this Limited Warranty will become the property of Sony.

This Limited Warranty only covers product issues caused by defects in material or workmanship during ordinary consumer use; it does not cover product issues caused by any other reason, including but not limited to product issues due to commercial use, acts of God, misuse, limitations of technology, or modification of or to any part of the Sony product or product purchased from other than Sony or a Sony Retailer. To determine if a retailer is part of the Sony Retailer Network, please contact Sony's Customer Service Call Center or go to www.sony.com/support. This Limited Warranty does not cover Sony products sold AS IS or WITH ALL FAULTS or consumables (such as fuses or batteries). This Limited Warranty is invalid if the factory-applied serial number has been altered or removed from the product. This Limited Warranty is valid only in the United States.

LIMITATION ON DAMAGES: SONY SHALL NOT BE LIABLE FOR ANY INCIDENTAL OR CONSEQUENTIAL DAMAGES FOR BREACH OF ANY EXPRESS OR IMPLIED WARRANTY ON THIS PRODUCT.

DURATION OF IMPLIED WARRANTIES: EXCEPT TO THE EXTENT PROHIBITED BY APPLICABLE LAW, ANY IMPLIED WARRANTY OF MERCHANTABILITY OR FITNESS FOR A PARTICULAR PURPOSE ON THIS PRODUCT IS LIMITED IN DURATION TO THE DURATION OF THIS WARRANTY.

Some states do not allow the exclusion or limitation of incidental or consequential damages, or allow limitations on how long an implied warranty lasts, so the above limitations or exclusions may not apply to you. This Limited Warranty gives you specific legal rights and you may have other rights which vary from state to state.

This warranty is valid only in Canada.



Consumer Warranty (Canada Only)

Sony of Canada Ltd. (hereinafter referred to as "Sony") hereby warrants, subject to the terms and conditions herein set forth, this product against defects in material and workmanship during the specified warranty period. In the event of a defect of material or workmanship during the specified warranty period, Sony will, without charge for parts or labour, either repair the product, effecting all necessary parts replacements with either new or refurbished parts, or at Sony's sole discretion, replace the product with a refurbished product of equal or better quality. **This limited warranty is valid only in Canada.**

The Warranty Period:

1. Labour: ONE YEAR from the date of original purchase at retail.
2. Parts: ONE YEAR (thermal head and projector lamp: 90 days) from the date of original purchase at retail.
3. Commercial or Rental Use: NINETY DAYS parts and labour from the date of original purchase.

Void or limited warranty:

This limited warranty is void if the product has been previously altered, modified, repaired or serviced by anyone other than the service facilities authorized by Sony, if the serial number on the product has been altered or removed, or if the product has been subject to accident, misuse, abuse, acts of God or operated contrary to the instructions contained in the Owner's Manual. This product is not intended for commercial or rental use. Should this product be used for commercial or rental use, Sony's standard ninety day commercial warranty will apply. The opinion of Sony with respect to these matters shall be final.

Proper Delivery for Service:

The product must be shipped, freight prepaid, or delivered to one of the nearest Sony service facilities in Canada in either its original package or similar package affording an equal degree of protection, and with instructions indicating a location within Canada to which the product should be returned. The repaired product will be returned to customer freight prepaid. Prior to shipping or delivering the product for repair, all accessories, media and other attachments should be removed from the product and all data and software must be backed up. It is likely that stored data and software will be lost, corrupted or reformatted in the course of service and Sony will not be liable for lost, corrupted or reformatted data or software. If more than the product is sent for repair, all items must be listed individually on the packing slip for the shipping documentation. Sony shall have no liability whatsoever for loss or damage to items that are not listed on the shipping documentation. Defective accessories should be returned to Sony as a separate repair item.

On-site service for televisions of certain dimensions may be available to a customer living within a 50km radius of an authorized Sony service facility, provided the residence can be accessed by an on-road service vehicle. Please go to www.fasttrackservice.ca or call 1-877-899-7669 to determine if on-site service applies to your television and residential location.

Proof of Original Purchase:

This limited warranty applies to the product from the date of original purchase. Therefore, the owner must furnish proof of original purchase at retail for the consumer warranty. For the commercial warranty, the owner must furnish proof of original purchase at retail or from a distributor. For subsequent purchasers, the date the first user acquired the product will apply as the original purchase.

This limited warranty does not extend to cosmetic damage, broken or damaged casing, accessories, exposed antennas and styluses, consumable items (such as batteries) provided with the product, parts wearing out due to normal wear and tear, damage caused by operation of the product with incompatible equipment or attachments, software issues (consult the End-User License Agreement for software terms and conditions, otherwise software is provided "AS IS") or to products sold "AS IS". This limited warranty does not cover regular product maintenance such as cleaning, lubrication or evaluation.

No Other Warranties; Limitation and Exclusion of Liability:

EXCEPT TO THE EXTENT PROHIBITED BY APPLICABLE LAW, ALL OTHER WARRANTIES AND CONDITIONS, EXPRESS OR IMPLIED, AND WHETHER ARISING BY LAW, BY STATUTE, BY COURSE OF DEALING OR USAGE OF TRADE, INCLUDING WITHOUT LIMITATION IMPLIED WARRANTIES OF MERCHANTABILITY, MERCHANTABLE QUALITY AND FITNESS FOR A PARTICULAR PURPOSE ARE DISCLAIMED. UNDER NO CIRCUMSTANCES SHALL SONY BE LIABLE FOR AN AMOUNT GREATER THAN THE ACTUAL PURCHASE PRICE OF THE UNIT, FOR ANY LOSS, DAMAGE OR CORRUPTION OF DATA, OR FOR ANY SPECIAL, INCIDENTAL OR CONSEQUENTIAL DAMAGES SUSTAINED IN CONNECTION WITH SAID UNIT AND SONY NEITHER ASSUMES NOR AUTHORIZES ANY REPRESENTATIVE OR OTHER PERSON TO ASSUME FOR IT ANY OBLIGATION OR LIABILITY OTHER THAN SUCH AS IS EXPRESSLY SET FORTH HEREIN.

Product Registration and Customer Support:

Thank you for choosing a Sony product. At Sony, we strive to create products of the highest quality to enhance your experience and enjoyment. To provide the best support for your product, we request that you complete a product registration form at www.Sony.ca/registration within ninety (90) days of purchase.

For service assistance, product information, product registration or to locate an authorized service facility please go to www.fasttrackservice.ca, or call: 1-877-899-7669.

For information about a Sony Care Extended Warranty, please call 1-800-773-9667.

For online product support and updates at any time, please visit: www.sony.ca/support, or call the Sony Customer Information Centre at 1-877-899-7669.

W 446022851



Български

С настоящето Сони Корпорация декларира, че това оборудване отговаря на основните изисквания и другите съответстващи клаузи на Директива 1999/5/ЕС. Подробности може да намерите на Интернет страницата:
<http://www.compliance.sony.de/>

Hrvatski

Ovime Sony Corporation izjavljuje da je ova oprema u skladu s osnovnim zahtjevima i ostalim relevantnim odredbama direktive 1999/5/EZ. Dodatne informacije potražite na sljedećoj internet adresi:
<http://www.compliance.sony.de/>

Česky

Sony Corporation tímto prohlašuje, že toto vybavení je ve shodě se základními požadavky a dalšími příslušnými ustanoveními směrnice 1999/5/ES. Podrobnosti lze získat na následující URL:
<http://www.compliance.sony.de/>

Dansk

Undertegnede Sony Corporation erklærer herved, at dette udstyr overholder de væsentlige krav og øvrige relevante krav i direktiv 1999/5/EF. For yderligere information gå ind på følgende hjemmeside:
<http://www.compliance.sony.de/>

Nederlands

Hierbij verklaart Sony Corporation dat dit toestel in overeenstemming is met de essentiële eisen en de andere relevante bepalingen van richtlijn 1999/5/EG. Nadere informatie kunt u vinden op:
<http://www.compliance.sony.de/>

English

Hereby, Sony Corporation, declares that this equipment is in compliance with the essential requirements and other relevant provisions of Directive 1999/5/EC. For details, please access the following URL:
<http://www.compliance.sony.de/>

Eesti keel

Sony Corporation kinnitab käesolevaga selle seadme vastavust 1999/5/EÜ direktiivi põhinõuetele ja nimetatud direktiivist tulenevatele teistele asjakohastele sätetele. Üksikasjalikum info:
<http://www.compliance.sony.de/>

Suomi

Sony Corporation vakuuttaa täten että tämä laite on direktiivin 1999/5/EY oleellisten vaatimusten ja sitä koskevien direktiivin muiden ehtojen mukainen. Halutessasi lisätietoja, käy osoitteessa:
<http://www.compliance.sony.de/>

Français

Par la présente Sony Corporation déclare que cet appareil est conforme aux exigences essentielles et aux autres dispositions pertinentes de la directive 1999/5/CE. Pour toute information complémentaire, veuillez consulter l'URL suivante :
<http://www.compliance.sony.de/>

Deutsch

Hiermit erklárt Sony Corporation, dass sich dieses Gerát in Übereinstimmung mit den grundlegenden Anforderungen und den übrigen einschlägigen Bestimmungen der Richtlinie 1999/5/EG befindet. Weitere Informationen erhältlich unter:
<http://www.compliance.sony.de/>

Ελληνικά

Με την παρούσα η Sony Corporation δηλώνει ότι ο παρόν εξοπλισμός συμμορφώνεται προς της ουσιώδεις απαιτήσεις και τις λοιπές σχετικές διατάξεις της οδηγίας 1999/5/EK. Για λεπτομέρειες παρακαλούμε όπως ελέγξετε την ακόλουθη σελίδα του διαδικτύου:
<http://www.compliance.sony.de/>

Magyar

Alulírott, Sony Corporation nyilatkozom, hogy ez a készülék megfelel a vonatkozó alapvető követelményeknek és az 1999/5/EK irányelv egyéb előírásainak. További információkat a következő weboldalon találhat:
<http://www.compliance.sony.de/>

Italiano

Con la presente Sony Corporation dichiara che questo apparecchio è conforme ai requisiti essenziali ed alle altre disposizioni pertinenti stabilite dalla direttiva 1999/5/CE. Per ulteriori dettagli, si prega di consultare il seguente URL:
<http://www.compliance.sony.de/>

Latviešu

Ar šo Sony Corporation deklarē, ka šis aprīkojums atbilst Direktīvas 1999/5/EK būtiskajām prasībām un citiem ar to saistītiem noteikumiem. Plašāka informācija ir pieejama:
<http://www.compliance.sony.de/>

Lietuvių kalba

Šiuo dokumentu Sony Corporation deklaruoja, kad ši įranga atitinka esminius reikalavimus ir kitas 1999/5/EB Direktyvos nuostatas. Susipažinti su visu atitikties deklaracijos turiniu Jūs galite interneto tinklalapyje:
<http://www.compliance.sony.de/>

Norsk

Sony Corporation erklærer herved at dette utstyret er i samsvar med de grunnleggende krav og øvrige relevante krav i direktiv 1999/5/EF. For flere detaljer, vennligst se:
<http://www.compliance.sony.de/>

Polski

Niniejszym Sony Corporation oświadcza, że to urządzenie jest zgodne z zasadniczymi wymaganiami oraz innymi stosownymi postanowieniami Dyrektywy 1999/5/WE. Szczegółowe informacje znaleźć można pod następującym adresem URL:
<http://www.compliance.sony.de/>

Português

Sony Corporation declara que este equipamento está conforme com os requisitos essenciais e outras disposições da Directiva 1999/5/CE. Para mais informações, por favor consulte o seguinte URL:
<http://www.compliance.sony.de/>

Română

Prin prezenta, Sony Corporation declară că acest tip de echipament respectă cerințele esențiale și este în conformitate cu prevederile Directivei 1999/5/EC. Pentru detalii, vă rugăm accesați următoarea adresă:
<http://www.compliance.sony.de/>

Slovensky

Sony Corporation týmto vyhlasuje, že toto zariadenie spĺňa základné požiadavky a všetky príslušné ustanovenia Smernice 1999/5/ES. Podrobnosti získate na nasledovnej webovej adrese:
<http://www.compliance.sony.de/>

Slovenščina

Sony Corporation izjavlja, da je ta oprema v skladu z bistvenimi zahtevami in ostalimi relevantnimi določili direktive 1999/5/ES. Za podrobnosti vas naprošamo, če pogledate na URL:
<http://www.compliance.sony.de/>

Español

Por medio de la presente Sony Corporation declara que este equipo cumple con los requisitos esenciales y cualesquiera otras disposiciones aplicables o exigibles de la Directiva 1999/5/CE. Para mayor información, por favor consulte el siguiente URL:
<http://www.compliance.sony.de/>

Svenska

Härmed intygar Sony Corporation att denna utrustning står i överensstämmelse med de väsentliga egenskapskrav och övriga relevanta bestämmelser som framgår av direktiv 1999/5/EG. För ytterligare information gå in på följande hemsida:
<http://www.compliance.sony.de/>

Support site

If you have any questions or for the latest support information on this product, please visit the web site below:

Site d'assistance

Si vous avez des questions ou si vous souhaitez consulter les toutes dernières informations techniques sur ce produit, rendez-vous sur le site Web suivant :

Sitio Web de soporte técnico en línea

Para resolver cualquier duda u obtener la información más reciente sobre el soporte técnico de este producto, visite el siguiente sitio Web:

<http://esupport.sony.com/>

If you have any questions/problems regarding this product, try the following:

- 1 Read Troubleshooting in these Operating Instructions.**
- 2 Please contact (U.S.A. only);**
Call **1-800-222-7669**
URL **<http://www.SONY.com>**



<http://www.sony.net/>

©2016 Sony Corporation Printed in Thailand