

# ***STANDARD HORIZON***

*Nothing takes to water like Standard Horizon*

## **HX380**

VHF FM Marine Transceiver

---

## **Owner's Manual**

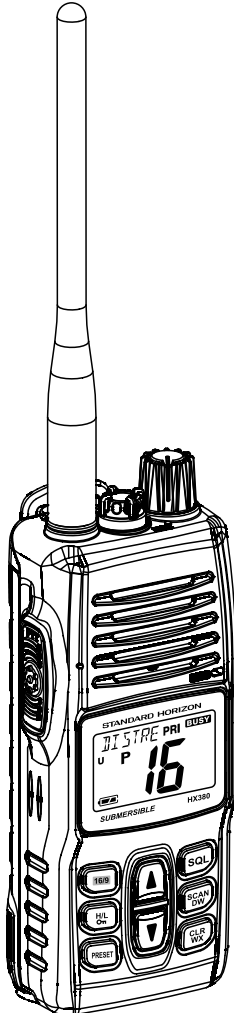

# TABLE OF CONTENTS

<b>WARNING! FCC RF EXPOSURE REQUIREMENTS</b> .....	<b>4</b>
<b>1. GENERAL INFORMATION</b> .....	<b>6</b>
1.1 INTRODUCTION.....	6
1.2 RF EXPOSURE SAFETY STATEMENT.....	6
<b>2. ACCESSORIES</b> .....	<b>7</b>
2.1 PACKING LIST.....	7
2.2 OPTIONS.....	7
<b>3. ABOUT THIS RADIO</b> .....	<b>8</b>
3.1 ABOUT THE VHF MARINE BAND.....	8
3.2 ABOUT THE LMR CHANNELS.....	8
3.3 ABOUT WATER RESISTANCE.....	8
3.4 EMERGENCY (CHANNEL 16 USE).....	8
3.5 CALLING ANOTHER VESSEL (CHANNEL 16 OR 9).....	9
3.6 OPERATING ON CHANNEL 13.....	10
3.7 OPERATING ON CHANNEL 67.....	10
3.8 SIMPLEX/DUPLEX CHANNEL USE.....	10
<b>4. GETTING STARTED</b> .....	<b>12</b>
4.1 RADIO CARE.....	12
4.2 BELT CLIP INSTALLATION.....	12
4.3 BATTERIES AND CHARGERS.....	13
4.3.1 BATTERY SAFETY.....	13
4.3.2 BATTERY INSTALLATION AND REMOVAL.....	14
4.3.3 BATTERY CHARGING.....	15
<b>5. CONTROLS AND INDICATORS</b> .....	<b>16</b>
5.1 CONTROLS AND SWITCHES.....	16
5.2 LCD INDICATORS.....	19
<b>6. BASIC OPERATION</b> .....	<b>20</b>
6.1 INITIAL SETUP.....	20
6.2 RECEPTION.....	20
6.3 TRANSMISSION.....	20
6.3.1 TRANSMIT TIME - OUT TIMER (TOT).....	21
6.4 USA, CANADIAN, AND INTERNATIONAL CHANNELS.....	21
6.5 NOAA WEATHER CHANNELS.....	22
6.5.1 NOAA WEATHER ALERT.....	22
6.5.2 NOAA WEATHER ALERT TESTING.....	22
6.6 KEYPAD LOCKING.....	23
6.7 PRESET CHANNELS (0 ~ 9): INSTANT ACCESS.....	23
6.7.1 PROGRAMMING.....	23
6.7.2 OPERATION.....	23
6.8 MEMORY SCAN.....	24
6.8.1 PROGRAMMING SCAN MEMORY.....	24
6.8.2 OPERATION.....	24
6.9 PRIORITY SCAN.....	25
6.10 DUAL WATCH.....	26
6.11 TRI-WATCH.....	26
<b>7. MENU ("SET") MODE</b> .....	<b>27</b>
<b>8. MAINTENANCE</b> .....	<b>30</b>
8.1 GENERAL.....	30
8.2 REPLACEMENT PARTS.....	30
8.3 FACTORY SERVICE.....	31
8.4 TROUBLESHOOTING CHART.....	31
<b>9. VHF MARINE CHANNEL ASSIGNMENTS</b> .....	<b>32</b>
<b>10. WARRANTY</b> .....	<b>36</b>
ON-LINE WARRANTY REGISTRATION.....	38
<b>11. INSTALLATION OF OPTION</b> .....	<b>39</b>
11.1 FBA-40 ALKALINE BATTERY TRAY.....	39
<b>12. SPECIFICATIONS</b> .....	<b>40</b>
12.1 GENERAL.....	40
12.2 TRANSMITTER.....	40
12.3 RECEIVER.....	41
<b>FCC AND CANADA RADIO LICENSE INFORMATION</b> .....	<b>42</b>

# QUICK REFERENCE GUIDE

This transceiver is equipped with the E2O (Easy-To-Operate) system. You can do the basic operation in numerical order of the illustration below.

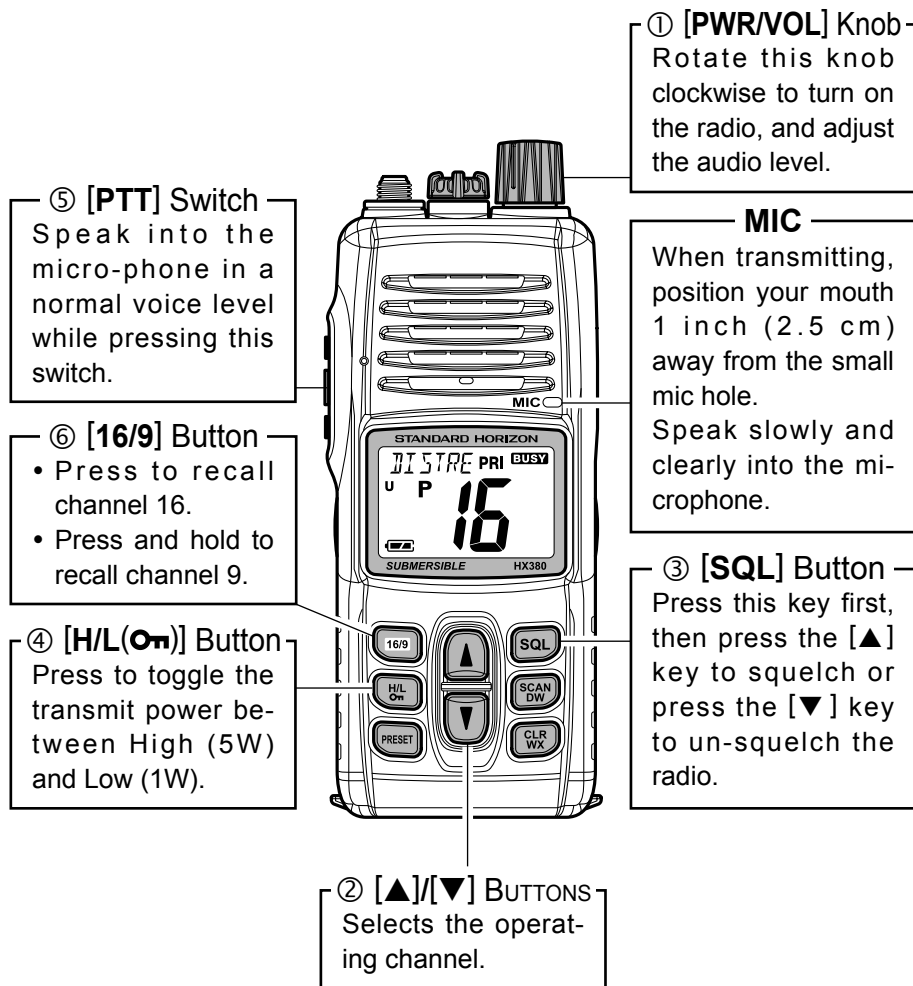

## WARNING! FCC RF EXPOSURE REQUIREMENTS

This Radio has been tested and complies with the Federal Communications Commission (FCC) RF exposure limits for Occupational Use/Controlled exposure environment. In addition, it complies with the following Standards and Guidelines:

- ❑ FCC 96-326, Guidelines for Evaluating the Environmental Effects of Radio-Frequency Radiation.
- ❑ FCC OET Bulletin 65 Edition 97-01 (2001) Supplement C, Evaluating Compliance with FCC Guidelines for Human Exposure to Radio Frequency Electromagnetic Fields.
- ❑ ANSI/IEEE C95.1-1992, IEEE Standard for Safety Levels with Respect to Human Exposure to Radio Frequency Electromagnetic Fields, 3 kHz to 300 GHz.
- ❑ ANSI/IEEE C95.3-1992, IEEE Recommended Practice for the Measurement of Potentially Hazardous Electromagnetic Fields - RF and Microwave.

### **WARNING:**

This radio generates RF electromagnetic energy during transmit mode. This radio is designed for and classified as **Occupational Use Only**, meaning it must be used only during the course of employment by individuals aware of the hazards, and the ways to minimize such hazards. This radio is not intended for use by the General Population in an uncontrolled environment.

### **CAUTION:**

To ensure that your exposure to RF electromagnetic energy is within the FCC allowable limits for occupational use, always adhere to the following guidelines:

- This radio is NOT approved for use by the general population in an uncontrolled exposure environment. This radio is restricted to occupational use, work related operations only where the radio operator must have the knowledge to control his or her RF exposure conditions.
- When transmitting, hold the radio in a vertical position with its microphone 1 inch (2.5 cm) away from your mouth and keep the antenna at least 1 inch (2.5 cm) away from your head and body.
- The radio must be used with a maximum operating duty cycle not exceeding 50%, in typical Push-to-Talk configurations.  
DO NOT transmit for more than 50% of total radio use time (50% duty cycle). Transmitting more than 50% of the time can cause FCC RF exposure compliance requirements to be exceeded.
- SAR compliance for body-worn use was only demonstrated for the specific belt-clip (**CLIP-920**). Other body-worn accessories or configurations may NOT comply with the FCC RF exposure requirements and should be avoided.

- The **CLIP-920** belt-clip must be used in order to comply with the FCC/IC RF exposure requirements.
- Always use Standard Horizon authorized accessories.
- The information listed above provides the user with the information needed to make him or her aware of RF exposure, and what to do to assure that this radio operates with the FCC RF exposure limits of this radio.
- Electromagnetic Interference/Compatibility  
During transmissions, this radio generates RF energy that can possibly cause interference with other devices or systems. To avoid such interference, turn off the radio in areas where signs are posted to do so.  
Do not operate the transmitter in areas that are sensitive to electromagnetic radiation such as hospitals, health care facilities, aircraft, and blasting sites.

# 1. GENERAL INFORMATION

## 1.1 INTRODUCTION

Congratulations on your purchase of the **HX380**! Whether this is your first portable marine VHF transceiver, or if you have other STANDARD HORIZON equipment, the STANDARD HORIZON organization is committed to ensuring your enjoyment of this high performance transceiver, which should provide you with many years of satisfying communications even in the harshest of environments. STANDARD HORIZON technical support personnel stands behind every product sold, and we invite you to contact us should you require technical advice or assistance.

The **HX380** is a Submersible 5-Watt portable two way marine transceiver with the capability to be programmed with 40 LMR (Land Mobile Radio) channels with CTCSS or DCS signalling by a dealer. The transceiver has all allocated International, Canadian, or USA channels. It has emergency channel 16 which can be immediately selected from any channel by pressing the  key.

The HX380 includes the following features: 10 PRESET channels for enabling the instant access, Memory Scanning, Priority Scanning, Battery Saver, easy-to-read large LCD display, EEPROM memory back-up, Battery Life displayed on the LCD, and a transmit Time-Out Timer (TOT).

The **HX380** transmitter provides a full 5 Watt of transmit power and also is selectable to 1 Watt to assist the user in ensuring maximum battery life.

We appreciate your purchase of the **HX380**, and encourage you to read this manual thoroughly, so as to learn and fully understand the capabilities of the **HX380**.

## 1.2 RF EXPOSURE SAFETY STATEMENT

Your wireless handheld portable transceiver contains a low power transmitter. When the Push-To-Talk (**PTT**: ) button is pushed, the transceiver sends out radio frequency (RF) signals.

This device is authorized to operate at a duty factor not to exceed 50% (this corresponds to 50% transmission time and 50% reception time).

This transmitter and its antenna must maintain a separation distance of at least 1 inch (2.5 cm) from your face. Speak in a normal voice, with the antenna pointed up and away from the face at the required separation distance.

Use only the supplied antenna. Unauthorized antennas, modifications, or attachments could damage the transmitter.

## 2. ACCESSORIES

### 2.1 PACKING LIST

When the package containing the transceiver is first opened, please check it for the following contents:

- **HX380** Transceiver
- **CAT460** Antenna (Antenna gain: -1.5 dBi, Impedance: 50 ohm)
- **FNB-V105LI** 7.4 V Li-Ion Battery Pack
- **CD-48** Charger Cradle for **HX380**
- **SAD-11B** or **SAD-18B** 120VAC Wall Charger for **CD-48**
- **E-DC-19A** DC Cable with 12 V Cigarette Lighter Plug
- Belt Clip
- Owner's Manual

### 2.2 OPTIONS

- ① **MH-73A4B** Speaker/Microphone
- ② **MH-57A4B** Mini Speaker/Microphone
- ③ **SSM-14A** Submersible Speaker/Microphone
- ④ **SSM-64A** VOX Headset
- ⑤ **SSM-55A** Earpiece/Microphone
- ⑥ **CN-3** Radio-to-Ship's Antenna Adapter
- ⑦ **CD-48** Charger Cradle
- ⑧ **FNB-V105LI** 7.4 V Li-Ion Battery Pack
- ⑨ **FBA-40** Alkaline Battery Case
- ⑩ **SAD-18B** AC Wall Charger for the **FNB-V105LI**
- ⑪ **E-DC-19A** DC Cable with 12 V Cigarette Lighter Plug
- ⑫ **E-DC-6** DC Cable; plug and wire only

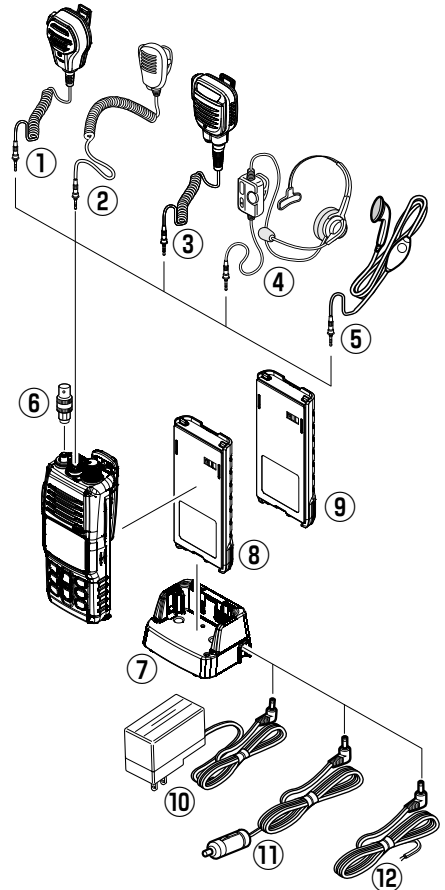

**Note:** Before operating the **HX380** for the first time, it is recommended that the battery be charged. Please see section “4.3.3 BATTERY CHARGING” for details.

## 3. ABOUT THIS RADIO

### 3.1 ABOUT THE VHF MARINE BAND

The radio frequencies used in the VHF marine band lie between 156 and 162 MHz. The marine VHF band provides communications over distances that are essentially “Line of sight” Actual transmission range depends much more on antenna type, gain and height than on the power output of the transmitter. On a fixed mount 25 W radio transmission expected distances can be greater than 15 miles, for a portable 5 W radio transmission the expected distance can be greater than 5 miles in “Line of sight”.

The user of a Marine VHF radio is subject to severe fines if the radio is used on land. The reasoning for this is you may be near an inland waterway, or propagation anomalies may cause your transmission to be heard in a waterway. If this occurs, depending upon the marine VHF channel on which you are transmitting, you could interfere with a search and rescue case, or contribute to a collision between passing ships. For VHF Marine channel assignments refer to page 32 section 9.

### 3.2 ABOUT THE LMR CHANNELS

The **HX380** is capable of being programmed with 40 LMR (Land Mobile Radio) channels by a dealer. The frequency range is 134 to 174MHz which may be setup for 25 kHz (wide) or 12.5 kHz (narrow) channel stepping with CTCSS and DCS signaling. Contact your dealer for further details.

### 3.3 ABOUT WATER RESISTANCE

Water resistance of the transceiver is ensured only when the battery pack is attached to the transceiver and **MIC/SP** cap is installed in the **MIC/SP** jack.

### 3.4 EMERGENCY (CHANNEL 16 USE)

Channel 16 is known as the Hail and Distress Channel. An emergency may be defined as a threat to life or property. In such instances, be sure the transceiver is on and set to “Channel 16”. Then use the following procedure:

1. Press the **PTT** (Push-To-Talk: ) switch and say “**Mayday, Mayday, Mayday**”. This is \_\_\_\_\_, \_\_\_\_\_, \_\_\_\_\_” (your vessel’s name).
2. Then repeat once: “**Mayday, \_\_\_\_\_**” (your vessel’s name).
3. Now report your position in latitude/longitude, or by giving a true or magnetic bearing (state which) to a well-known landmark such as a navigation aid or geographic feature such as an island or harbor entry.
4. Explain the nature of your distress (sinking, collision, aground, fire, heart attack, life-threatening injury, etc.).
5. State the kind of assistance your desire (pumps, medical aid, etc.).
6. Report the number of persons aboard and condition of any injured.



7. Estimate the present seaworthiness and condition of your vessel.
8. Give your vessel's description: length, design (power or sail), color and other distinguishing marks. The total transmission should not exceed 1 minute.
9. End the message by saying "**OVER**". Release the **PTT** () switch and listen.
10. If there is no answer, repeat the above procedure. If there is still no response, try another channel.

### **3.5 CALLING ANOTHER VESSEL (CHANNEL 16 OR 9)**

Channel 16 may be used for initial contact (hailing) with another vessel.

However, its most important use is for emergency messages. This channel must be monitored at all times except when actually using another channel.

It is monitored by the U.S. and Canadian Coast Guards and by other vessels. Use of channel 16 for hailing must be limited to initial contact only. Calling should not exceed 30 seconds, but may be repeated 3 times at 2-minute intervals. In areas of heavy radio traffic, congestion on channel 16 resulting from its use as a hailing channel can be reduced significantly in U.S. waters by using Channel 9 as the initial contact (hailing) channel for non-emergency communications. Also hailing on channel 9, the calling time should not exceed 30 seconds but may be repeated 3 times at 2-minute intervals.

Prior to making contact with another vessel, refer to the channel charts in this manual, and select an appropriate channel for communications after initial contact. For example, Channels 68 and 69 of the U.S. VHF Charts are some of the channels available to non-commercial (recreational) boaters. Monitor your desired channel in advance to make sure you will not be interrupting other traffic, and then go back to either channel 16 or 9 for your initial contact.

When the hailing channel (16 or 9) is clear, state the name of the other vessel you wish to call and then "**this is**" followed by the name of your vessel and your Station License (Call Sign). When the other vessel returns your call, immediately request another channel by saying "**go to**", the number of the other channel, and "**over**". Then switch to the new channel. When the new channel is not busy, call the other vessel.

After a transmission, say "**over**", and release the **PTT** (Push-To-Talk: ) switch. When all communication with the other vessel is completed, end the last transmission by stating your Call Sign and the word "**out**". Note that it is not necessary to state your Call Sign with each transmission, only at the beginning and end of the contact.

Remember to return to Channel 16 when not using another channel.

### 3.6 OPERATING ON CHANNEL 13

Channel 13 is used at docks, bridges and for maneuvering in port. Messages on this channel must concern navigation only, such as meeting and passing in restricted waters. In emergencies and when approaching blind river bends, High power is allowed. Pressing the  key will change the power output from Low Power (1 Watt) to High (5 Watts). When you change from this channel then return to it, low power will be automatically selected.

### 3.7 OPERATING ON CHANNEL 67

When channel 67 is used for navigational bridge-to-bridge traffic between ships, High power may be used temporarily (in the USA band) by pressing the  key. When release the **PTT** switch, the transceiver will revert to low power.

### 3.8 SIMPLEX/DUPLEX CHANNEL USE

Refer to the VHF MARINE CHANNEL CHART (page 32) for instructions on use of simplex and duplex channels.

#### NOTE

All channels are factory-programmed in accordance with FCC, Industry Canada, and International regulations. The mode of operation cannot be altered from simplex to duplex or vice-versa. Simplex (ship to ship) or duplex (marine operator) mode is automatically activated, depending on the channel and whether the USA, Canadian or International operating band is selected.



## 4. GETTING STARTED

### 4.1 RADIO CARE

#### CAUTION

Before following the instructions below, insure the battery pack is in place and firmly connected. Care must be taken if the radio was dropped and a close inspection may be needed to insure the radio case and gaskets are in adequate condition.

The design of the **HX380** allows water to enter between the radio and the battery pack, however waterproof performance is not compromised.

After using the **HX380** in salt water environment is recommended to clean the radio with fresh water by rinsing the battery and radio (separately) under a sink facet or by dunking in a fresh water. After washing, use a soft cloth to thoroughly dry all parts of the radio and battery.

This will keep the radio parts and the battery clean and in top operating condition.

### 4.2 BELT CLIP INSTALLATION

Insert the mounting screw through the belt clip, and affix it snugly to the mounting hole on the back of the transceiver.

#### CAUTION

Do not install the supplied Belt Clip Mounting Screws if you are not installing the Belt Clip! Also, do not use an improper screw for mounting the Belt Clip! An improper screw may cause a "short circuit" to the internal circuitry, causing serious damage!

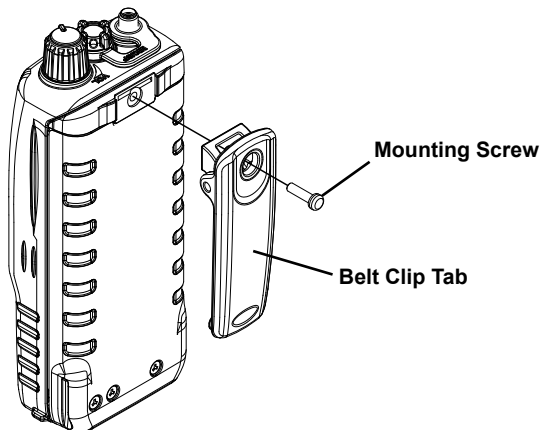

## 4.3 BATTERIES AND CHARGERS

If the radio has never been used, or its charge is depleted, it may be charged by connecting the **CD-48** Charger Cradle with the **SAD-11B** or **SAD-18B** Battery Charger, as shown in the illustration. If 12V DC power is available, the supplied **E-DC-19A** DC Cable with 12 V Cigarette Lighter Plug may be used for charging the battery. The **SAD-11B** or **SAD-18B** and **E-DC-19A** will charge a completely discharged **FNB-V105LI** battery pack in approximately 3 hours.

The **FNB-V105LI** is a high performance Li-Ion battery providing high capacity in a compact package.

### CAUTION

To avoid risk of explosion and injury, **FNB-V105LI** battery pack should only be removed, charged or recharged in non-hazardous environments.

#### 4.3.1 BATTERY SAFETY

Battery packs for your transceiver contain Li-Ion batteries. This type of battery stores a charge powerful enough to be dangerous if misused or abused, especially when removed from the transceiver. Please observe the following precautions:

**DO NOT SHORT BATTERY PACK TERMINALS:** Shorting the terminals that power the transceiver can cause sparks, severe overheating, burns, and battery cell damage. If the short is of sufficient duration, it is possible to melt battery components. Do not place a loose battery pack on or near metal surfaces or objects such as paper clips, keys, tools, etc. When the battery pack is installed on the transceiver, the terminals that transfer current to the transceiver are not exposed. The terminals that are exposed on the battery pack when it is mounted on the transceiver are charging terminals only and do not constitute a hazard.

**DO NOT INCINERATE:** Do not dispose of any battery in a fire or incinerator. The heat of fire may cause battery cells to explode and/or release dangerous gases.

#### Battery Maintenance

For safe and proper battery use, please observe the following:

- Battery packs should be charged only in non-hazardous environments;
- Use only STANDARD HORIZON-approved batteries;
- Use only a STANDARD HORIZON approved charger. The use of any other charger may cause permanent damage to the battery.
- Follow charging instructions provided with the chargers.
- Keep the battery contacts clean and dry.

### Battery Storage

Store the batteries in a cool place to maximize storage life. Since batteries are subject to self-discharge, avoid high storage temperatures that cause large self-discharge rates. After extended storage, a full recharge is recommended.

### Battery Recycling

**DO NOT PLACE USED BATTERIES IN YOUR REGULAR TRASH!  
LI-ION BATTERIES MUST BE COLLECTED, RECYCLED OR DISPOSED  
OF IN AN ENVIRONMENTALLY SOUND MANNER.**

The incineration, land filling or mixing of Li-Ion batteries with the municipal solid waste stream is PROHIBITED BY LAW in most areas.

Return batteries to an approved Li-Ion battery recycler. This may be where you purchased the battery.

Contact your local waste management officials for other information regarding the environmentally sound collection, recycling and disposal of Li-Ion batteries.

### 4.3.2 BATTERY INSTALLATION AND REMOVAL

To install the battery pack, hold the transceiver with your left hand, so your palm is over the speaker. Insert the battery pack into the battery compartment on the back of the radio, then push the bottom side of the battery pack until the battery pack locks with the Battery Pack Latch.

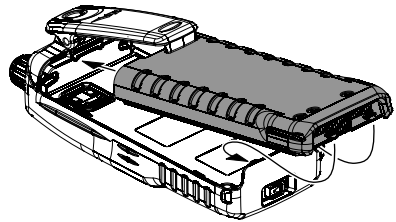

To remove the battery, turn the radio off. Slide the Battery Pack Latch on the bottom of the radio, then lift up on the bottom of the battery and remove it from the radio.

### **4.3.3 BATTERY CHARGING**

1. Turn the transceiver off.
2. Insert the DC plug from the **SAD-11B** or **SAD-18B** into the DC jack on the **CD-48** side panel, then plug the **SAD-11B** or **SAD-18B** into the AC line outlet.
3. Insert the **HX380** (with the battery pack) into the **CD-48**; the antenna should be at the left side when viewing the charger from the front.
4. If the **HX380** is inserted correctly, the Red "**CHARGING**" indicator will glow. A fully-discharged pack will be charged completely in approximately 7 hours.
5. When charging is completed, the red LED indicator will change to green. Remove the transceiver from the **CD-48**, and unplug the **SAD-11B** or **SAD-18B** from the AC line outlet.

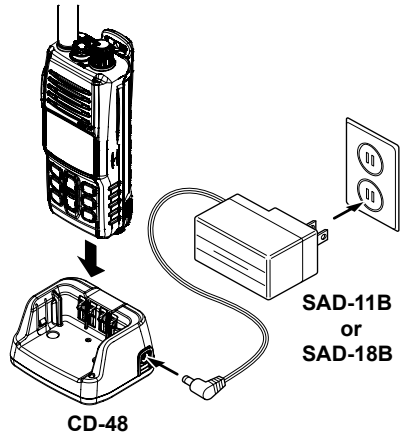

#### **⚠ WARNING ⚠**

- Do not reverse-connect the battery terminals.
- Do not parallel-connect the battery terminals.
- Do not change batteries in hazardous locations.
- To reduce the risk of explosion, recharge the batteries outside of hazardous locations.

#### **CAUTION**

The **CD-48** cradle is NOT designed to be waterproof. Do not attempt to charge in water hazardous locations.

#### **NOTE**

The **CD-48** cradle is only designed for the charging of the **HX380**'s battery, and is not suitable for other purposes. The **CD-48** may contribute noise to TV and radio reception in the immediate vicinity, so we do not recommend its use adjacent to such device.

## 5. CONTROLS AND INDICATORS

### 5.1 CONTROLS AND SWITCHES

#### NOTE

This section defines each control of the transceiver. For detailed operating instructions, refer to section “6. BASIC OPERATION”. Refer to illustrations for the location of the following controls, switches, and connections.

① **ANT** Jack (Top Panel)

The supplied **CAT460** flexible antenna is attached here.

② **MIC/SP** Jack (Top Panel)

The jack accepts the optional **SSM-14A** Submersible Speaker/Microphone, **MH-73A4B** Speaker/Microphone, **MH-57A4B** Mini Speaker/Microphone, **SSM-64A** VOX Headset, or **SSM-55A** Earpiece/Microphone. When this jack is used, the internal speaker and microphone are disabled.



**1) Do not allow the HX380 to become submerged in water while the plastic cover over the MIC/SP jack is removed.**  
**2) Do not remove/install the optional Speaker Microphone in a hazardous location.**

③ **POWER** Switch / **VOLUME** Control (**VOL**)

Turns the transceiver on and off as well as adjusts the audio volume level. Turn this knob clockwise to turn the radio on and increase the speakers audio volume.  
Turn fully counter-clockwise to turn the radio off.

④ **PTT** (PUSH-TO-TALK) Switch

When pushed activates the transmitter.

⑤ **LCD** Display

This display shows current operating conditions. Refer to page 19 for details.

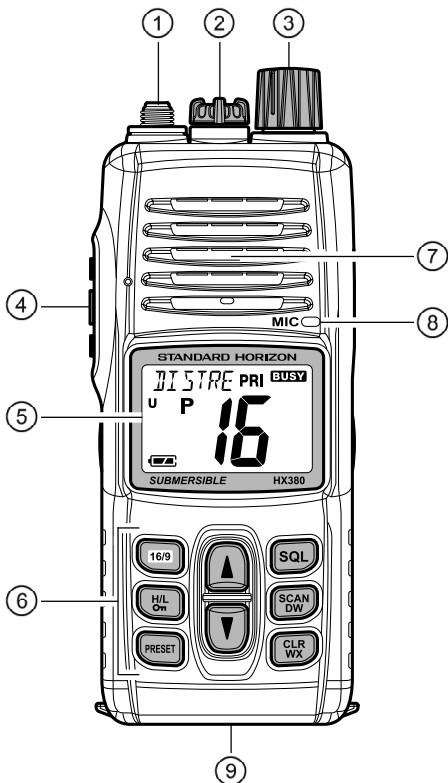



## ⑥ Keypad

### Key

Pressing this key immediately recalls channel 16 from any channel location. Holding down this key recalls channel 9. Pressing this key again reverts to the previous selected working channel.

#### **Secondary use:**

When the  key is held and the  key is pressed, the radio will change the marine band between the International, Canadian, and USA channels.





#### **Advanced use:**

When the  key is held and the  key is pressed, the radio will change the priority channel between the Channel 16, Channel 9, and the Preset Channel.

### Key

Press this key to toggle the transmitter output power between “High” (5 Watts) and “Low” (1 Watt) power. When the “Low” power is selected, the “” icon will appear to the right of the channel indication on the display. This key does not function on the “Transmission Inhibited” and “Low power only” channels.



#### **Secondary use:**

Hold down this key to lock the keypad (except the ,  and **PTT** () keys) so that they are not accidentally changed. The “” icon will appear at the right of the channel indication on the display, to indicate that the functions are locked. Hold down this key until the “” icon disappears to unlock the radio.

#### **Advanced use:**

When the  key is held and the  key is pressed, the radio will change the priority channel between the Channel 16, Channel 9, and the Preset Channel.

### Key

Press this key to recall the user preset memory channels (shown as memory channel number “0” - “9” on the display). Press the  or  key to select the desired preset channel.

Press and hold this key for two seconds to memorize the selected channel into the preset memory.

### Key

Press the key momentarily to increase the channel one step. Hold the key down to increase the channel continuously.

#### **Secondary use:**

Used to adjust the squelch threshold level up after the  key is pressed.



### Key

Press the key momentarily to decrease the channel one step. Hold the key down to decrease the channel continuously.

#### **Secondary use:**

Used to adjust the squelch threshold level down after the  key is pressed.

### Key

Press this key to activate the squelch adjusting mode. Press the  or  key to adjust the squelch threshold level.

#### **Secondary use:**

Press and hold this key for two seconds to open the squelch, allowing you to monitor the operating channel. Release the key to resume normal (quiet) monitoring.

### Key

Starts scanning and priority scanning of programmed channels.

#### **Secondary use:**

Press and hold the  key for two seconds to activate the Dual Watch feature.

### Key

Press to stop the Scan, Priority Scan, or Dual Watch feature.

#### **Secondary use:**

Press and hold this key to immediately recall the last-used NOAA Weather Channel from any channel location. Recalls the previously- selected working channel when the  key is pressed again.

#### **Advanced use:**

When the  key is held and the  key is pressed, the radio will change the marine band between the USA, International, and Canadian channels.

### ⑦ Speaker

The internal speaker is located here.

### ⑧ Microphone

The internal microphone is located here.

When transmitting, position your mouth 1 inch (2.5 cm) away from the small mic hole. Speak slowly and clearly into the microphone.

### ⑨ Battery Pack Lock (Bottom side)

Slide the Battery Pack Lock to the “◀” position for battery removal.

## 5.2 LCD INDICATORS





- ① Alpha/numeric “Tag” display  
Indicates the current channel name or operating mode.

- ② “PRI” Indicator  
This indicator is shown when the Priority channel is selected.

- ③ “BUSY” Indicator  
This indicator appears when a signal is being received or when the radio is unsquelched.





- ④ “U/I/C” Indicator  
These indicators show the “band” of operation for the particular channel. “U” indicates the USA band; “I” indicates the International band; and “C” indicates the Canadian band.

- ⑤ “P” Indicator  
This indicator shows the channel is in the “PRESET” channel memory.

- ⑥ “” Battery Indicator  
“”: Full battery  
“”: Lower battery  
“”: Battery is very low  
“ (Blinking)”: Prepare to charge the battery

- ⑦ Channel Display  
The operating channel is shown on the LCD in both the transmission and reception modes.

- ⑧ “TX” Indicator  
This indicator appears during transmission.

- ⑨ “” Indicator  
When the “” icon is shown on the LCD, all keys are disabled except for the PTT () , SQL () , and  keys.

- ⑩ “” Indicators  
This indicator shows when the TX output power is selected to “Low” (1 Watt) power.

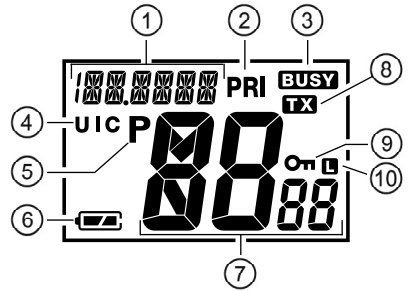

## 6. BASIC OPERATION

### 6.1 INITIAL SETUP

1. Install the battery pack on the transceiver (see section “4.3.2 BATTERY INSTALLATION AND REMOVAL”).
2. Install the antenna onto the transceiver; hold the bottom end of the antenna, then screw it onto the mating connector on the transceiver until it is snug. Do not over-tighten.

### 6.2 RECEPTION

1. Turn the **VOL** knob clockwise to turn the transceiver on.  
The battery voltage will appear briefly at the upper left corner on the display, then the channel name will appear.
2. Press the **[SQL]** key to activate the squelch adjusting mode (The “SQL LVL” notation will appear). Press the **[V]** key until the “**BUSY**” indicator appears on the display, then press the **[SQL]** key again.
3. Turn the **VOL** knob clockwise until the noise or audio from the speaker is at a comfortable level.
4. Press the **[SQL]** key, then press the **[A]** key until the random noise disappears. This state is known as the “Squelch Threshold”.
5. Press the **[A]** or **[V]** key to select the desired channel. Refer to the channel chart on page 33 for available channels.
6. When a signal is received, adjust the **VOL** knob to the desired listening level. The “**BUSY**” indicator on the LCD is displayed indicating that the channel is being used.

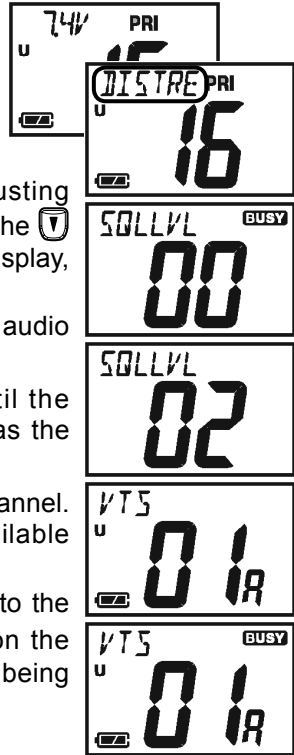



### 6.3 TRANSMISSION

1. Perform “6.2 RECEPTION” discussion above.
2. Before transmitting, monitor the channel and make sure it is clear.

#### **THIS IS AN FCC REQUIREMENT!**





3. For communications over short distances, press the **[HL ON]** key to select Low power (1 watt: “**L**” icon appears).  
**Note:** Transmitting on Low power prolongs battery life. Low power should be selected whenever possible.

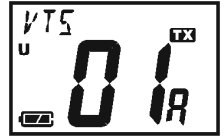

4. If using Low power is not effective, select High power (5 watts: “**H**” icon disappears) by pressing the  key.
5. When receiving a signal, wait until the incoming signal stops before transmitting. The transceiver cannot transmit and receive simultaneously.
6. Press and hold the **PTT** (Push-To-Talk: ) switch to transmit. During transmission, the “**TX**” indicator will appear on the display.
7. Position your mouth 1 inch (2.5 cm) away from the mic hole. Speak slowly and clearly into the microphone.
8. When the transmission is finished, release the **PTT** () switch.





### 6.3.1 TRANSMIT TIME - OUT TIMER (TOT)

While the **PTT** () switch is held down, transmission time is limited to 5 minutes. This prevents prolonged (unintentional) transmissions. About 10 seconds before automatic transmitter shutdown, a warning beep will sound from the speaker. The transceiver automatically switches to the receiving mode, even if the **PTT** () switch is held down. Before transmitting again, the **PTT** () switch must first be released. This Time-Out-Timer (TOT) prevents a continuous transmission that would result from an accidentally stuck **PTT** () switch.

#### NOTE

The **PTT** () switch is disabled for 10 seconds after the transceiver automatically switches to the receiving mode by the TOT feature.

## 6.4 USA, CANADIAN, AND INTERNATIONAL CHANNELS

1. To change from US to Canadian or International Marine Channels, hold down the  key and press the  key. The band will change from USA, to Canadian, and to International with each press.
2. “**U**” appears on the LCD for the USA band, “**C**” appears for the Canadian band, and “**I**” appears for the International band.
3. Refer to the marine channel charts in section “**9 VHF MARINE CHANNEL ASSIGNMENTS**” for allocated channels.



“USA” BAND







“CANADIAN” BAND



“INTERNATIONAL” BAND

## 6.5 NOAA WEATHER CHANNELS

In the event of a major storm or other appreciable weather condition requiring vessels at sea (or other bodies of water) to be notified, the NOAA (National Oceanographic and Atmospheric Administration) broadcasts a 1050 Hz tone which the **HX380** can detect and alert you of pending storm warnings. The 1050 Hz tone, when detected, will produce a loud beep in the speaker of the **HX380**, to signal that a Weather Alert Broadcast is being received.

1. To receive a NOAA (National Oceanic and Atmospheric Administration) weather broadcast, press and hold the  key. The transceiver changes to the weather channel mode and recalls the last used NOAA weather channel. This mode consists of a preset memory bank containing the NOAA weather channels.
2. Press the  or  key to change to other weather channels.
3. To exit from the weather channel mode, press and hold the  key. The transceiver will revert to the channel you were using prior to switching to the weather channel mode.



### 6.5.1 NOAA WEATHER ALERT

In the event of extreme weather disturbances such as storms and hurricanes, NOAA sends a “weather alert” consisting of a 1050 Hz tone, followed by weather reports on the weather channels.

When a “weather alert” is received on a weather channel, the transceiver emits a beep tone. Press the  key to stop the beep tone and listen to the weather reports.

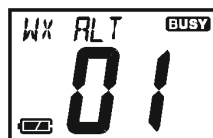





### 6.5.2 NOAA WEATHER ALERT TESTING

In order to test this system, NOAA broadcasts the 1050 Hz tone every Wednesday sometime between 11 AM and 1 PM local time. You may use this opportunity to test your **HX380** periodically to confirm that the Weather Alert feature is working, or for training crew members on how to configure the **HX380** to receive the NOAA Weather Alerts.

## 6.6 KEYPAD LOCKING

In order to prevent accidental channel change, the **HX380**'s keypad may be locked.

1. Hold down the  key to lock the keypad (except the **PTT** () , **SQL** () , and  keys) so that they are not accidentally changed. The “**On**” icon will appear next to the channel number on the display, indicating that the functions are locked.

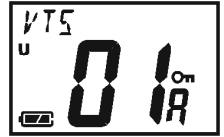



2. Hold down the  key until the “**On**” icon disappears to unlock the radio.



## 6.7 PRESET CHANNELS (0 ~ 9): INSTANT ACCESS

Ten user assigned channels can be programmed for instant access. Pressing the  key activates the user assigned channel bank.

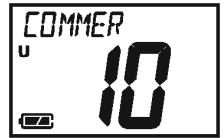

### 6.7.1 PROGRAMMING

1. Select the desired channel to be saved into the Preset channel bank using the  or  key.

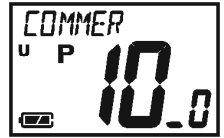

2. Press and hold the  key until the channel number blinks. The “**P**” icon and Preset channel number blink, then release the  key.



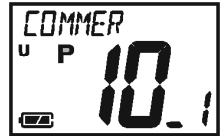

3. Press the  or  key to select the desired Preset channel (“0” ~ “9”). If you see the “Underscore” between the current channel number and the Preset channel number, it means that the Preset channel currently has no data written on it (i.e. the channel is “free”).



4. Press the  key to program the current channel into the Preset channel bank.



5. Repeat steps 3 and 4 to program the other channel into the Preset Channels, if desired.

6. To delete a Preset Channel, select the Preset Channel Number to be deleted using the  or  key, then press and hold the  key until the Preset Channel Number is removed from the display.

### 6.7.2 OPERATION

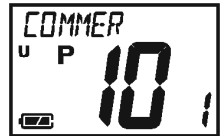
1. Press the  key to change the transceiver to the Preset channel mode. The “**P**” icon and Preset channel number will appear on the display.



2. Press the  or  key to select the desired Preset Channels (“0” through “9”).











3. To exit from the Preset channel mode, press the  key. The transceiver will revert to the channel you were on prior to switching to the Preset channel mode.

## 6.8 MEMORY SCAN

The **HX380** will automatically scan channels programmed into Preset Channel Memory and also channels store into Scan Memory.



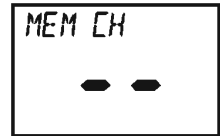

When an incoming signal is detected on one of the channels during scan, the radio will pause on that channel, allowing you to listen to the incoming transmission. The radio will automatically start scanning again after the transmission stops.

### 6.8.1 PROGRAMMING SCAN MEMORY

1. Turn the transceiver off by rotating the **VOL** knob fully counter-clockwise.
2. Hold down the  key, and then turn on the transceiver while still holding down the  key.
3. Press the  or  key to select “MEM CH” and press the  key.
4. Press the  or  key to select desired channel to be scanned, then press the  key. The “M” icon appears on the display, which indicates the channel has been selected to the scan channel.
5. Repeat step 4 for all the desired channels to be programmed into scan memory.
6. To DELETE a channel from the list, select the channel then press the  key. The “M” icon disappears from the display.
7. When you have completed programming the scan memory, press the  key to save your changes, and then press the  key to exit to normal operation.



### 6.8.2 OPERATION







1. Press the  key to activate the squelch adjusting mode, then press the  /  key until the background noise disappears.
2. Press the  key to start scanning channels programmed into memory and preset channels. “MSCAN” will be shown in the upper left corner of the display.
3. When the **HX380** receives a transmission, it will stop on the channel until the incoming signal disappears, then start scanning again.
4. To stop scanning, press the  key.





## 6.9 PRIORITY SCAN





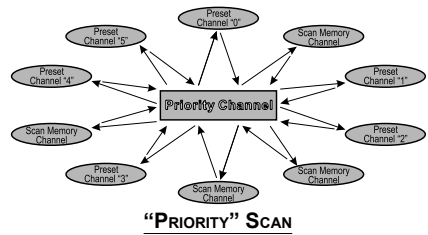
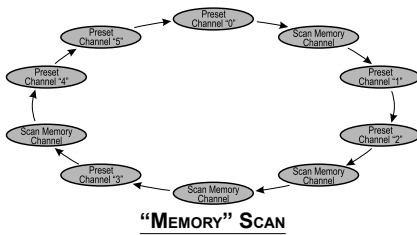
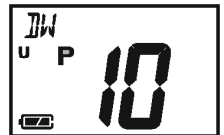
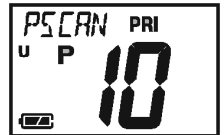
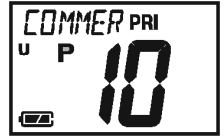

The Priority Scan is similar to the Memory Scan. However, the Priority Scan monitors the Preset Channels, Scan Memory Channels and the Priority Channel. The following channels can be set as the Priority channel: CH16, CH9, or one of the Preset channel (default setting is CH16).

- To set the priority channel, hold down the  key and press the  key. The channel will change from 16 to 09 to Preset channels 0 through 9 with each press of the  key. When the  key is released the displayed channel will be set as the priority channel (the "PRI" icon will appear above of the channel number).
- Press the  key to start Scanning.
- Press and hold the  key to start Priority Scan, "PSCAN" will be shown on the display.
- When the **HX380** receives a transmission on a working channel, it will stop on the working channel and dual watch to the priority channel until the incoming signal disappears, then start scanning again.
- When the **HX380** receives a signal on the Priority channel it will stay on this channel until the incoming signal disappears, then start Priority scanning again.
- To stop Priority Scanning, press the  key.



## 6.10 DUAL WATCH

The Dual Watch feature allows the radio to scan between the Priority Channel and one other channel.

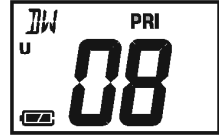

1. To set the Priority channel, hold down the  key and press the  key, when the channel you want is shown, release the  key.
2. Select the desired channel you want to Dual watch to the priority channel using the  or  key.
3. Press and hold the  key for two seconds to activate the Dual Watch feature. A “DW” notation will appear on the upper left corner of the display when the Dual Watch feature is activated.
4. When a transmission is received on the “Priority” channel, the radio will stay on the “Priority Channel” until the incoming signal disappears.
5. When the radio receives a transmission on the working channel, the radio will Dual Watch between the working channel and Priority channel.
6. The radio will resume Dual Watch when the incoming signal disappears at the end of the transmission.
7. To stop the Dual Watch feature and return to normal operation, press the  key briefly.



## 6.11 TRI-WATCH

You may change the Dual Watch feature to Tri-watch via the Menu (“Set”) Mode. Refer to Menu Mode Item “**DUAL WATCH MODE**” on page 28 for details.

Tri-Watch scans Channel 16, 9, and one other channel. When enabled the **HX380** will show “TW 16/9” in the upper left corner of the display.



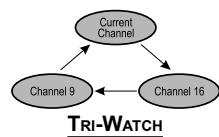
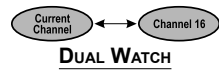
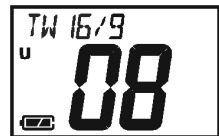





1. Press and hold the  key for two seconds to activate the TRI-Watch feature. “TW 16/9” will appear on the upper left corner of the display when the Tri-Watch feature is activated.
2. When a transmission is received on the channel 16, radio will stay on the channel 16 until the incoming signal disappears.
3. When a transmission is received on the channel 9, the radio will Dual watch between the channel 16 and channel 9.
4. When the radio receives a transmission on the working channel, the radio will Tri-watch between the working channel, channel 16 and channel 9.
5. To stop the Tri-watch feature and return to normal operation, press the  key.



## 7. MENU (“SET”) MODE

The Setup Menu allows a number of the **HX380** operating parameters to be custom-configured for your operating requirements.

The Menu Mode is easy to activate and set, using the following procedure:

1. Turn the transceiver off by rotating the **VOL** knob fully counter-clockwise.
2. Hold down the  key, then turn on the transceiver while still holding down the  key.
3. The Menu item will scroll on the upper left corner of the display and its current status or value will appear on the large display.
4. Press the  or  key to select the Menu item to be adjusted.
5. Press the  key to enable adjustment of the selected Menu item. The current status or value will blink.
6. Press the  or  key to select the desired status or value of the Menu item.
7. After completing your adjustment, press the  key to save the new setting.
8. If you wish to change another Menu item, repeat steps 4 to 7 above.
9. Press the  key to exit to normal operation.

### BEEP LEVEL

**Function:** Enables/Disables the Keypad beep.

**Available Values:** HI / Lo / oFF

**Default:** HI



### LAMP MODE

**Function:** Selects the Lamp illumination method for the LCD/Keypad.

**Available Values:** KEY / Cnt (Continuous) / oFF

**Default:** KEY

**KEY:** Illuminates the LCD/Keypad for 5 seconds when any key is pressed.

**Cnt (Continuous):** Illuminates the LCD/Keypad continuously.

**oFF:** Turns off the backlight for the LCD and keys.



### SCAN LAMP

**Function:** Enables/Disables the Lamp while scanner is paused.

**Available Values:** on / oFF

**Default:** on

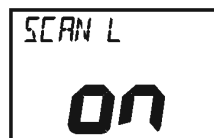

## DUAL WATCH MODE

**Function:** Selects dual or tri-watch as desired.

**Available Values:** t- (Tri Watch) / d- (Dual Watch)

**Default:** d- (Dual Watch)

t- (Tri Watch): The radio watches the activity of CH16, CH9, and the current channel.

d- (Dual Watch): The radio watches the the activity of the current channel and the Priority channel.

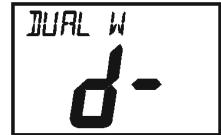

## DIMMER MODE

**Function:** Selects the display brightness level.

**Available Values:** 0 / 1 / 2 / 3

**Default:** 3



## WX ALERT MODE

**Function:** Enables/Disables the NOAA Weather Alert function.

**Available Values:** on / oFF

**Default:** on



## DUAL WATCH DISPLAY

**Function:** Selects the display mode while Dual Watch scanning.

**Available Values:** nor (Normal) / SPC (Special)

**Default:** nor (Normal)

When this menu is set to "Normal", the channel numbers during dual watch will be shown scrolling on the display. When "Special" is selected the channel numbers on the display do not change unless a call was received. The channel shown is the last channel that was received. This is a handy feature if you cannot look at the radio the moment a transmission was received.

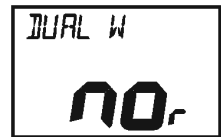

## SCAN DISPLAY

**Function:** Selects display mode while scanning.

**Available Values:** nor (Normal) / SPC (Special)

**Default:** nor (Normal)

When this menu is set to "Normal", the channel numbers during dual watch will be shown scrolling on the display. When "Special" is selected the channel numbers on the display do not change unless a call was received. The channel shown is the last channel that was received. This is a handy feature if you cannot look at the radio the moment a transmission was received.

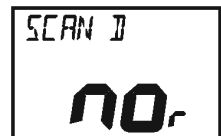











## CH NAME

**Function:** Changes the channel name shown on the display.



To change the channel name:

1. Select the channel you wish to change the name *before* following the steps below.
2. Turn off the **HX380** by rotating the **VOL** knob counter clockwise.
3. Hold down the  key, then turn on the transceiver while still holding down the  key.
4. Press the  or  key to select "CH NAME".
5. Press the  key. The current channel name will appear on the upper left corner of the display.
6. Press the  or  key to select the first character (letter, number, or symbol) in the name, then press the  key to move to the next character.
7. Repeat step 6 as many times as necessary to complete the name tag (up to 12 characters).
8. After completing your adjustment, press the  key to save the new setting.
9. Press the  key to exit to normal operation.

## MEM CH

**Function:** Programming Scan Memory.

See page 24 for details of the programming.



## 8. MAINTENANCE

### 8.1 GENERAL

The inherent quality of the solid-state components in STANDARD HORIZON radios will provide many years of continuous use. Take the following precautions to prevent damage to the radio.

- To prevent corrosion of electrical contacts and keep the water resistance, keep the microphone or the jack connected at all times.
- Never press the **PTT** switch unless an antenna or suitable dummy load is connected to the antenna receptacle.
- Ensure that the input voltage does not exceed the value specified in your Owner's Manual.
- Use only STANDARD HORIZON-approved accessories and replacement parts.

### 8.2 REPLACEMENT PARTS

Occasionally an owner needs a replacement part. Items can be ordered from our Parts Department by writing or calling (in USA or Canada), or Standard Horizon/Yaesu authorized dealers (outside USA or Canada).

**Marine Division of YAESU U.S.A.**

6125 Phyllis Drive, Cypress, CA 90630, U.S.A.

Telephone (800) 767-2450

Commonly requested parts, and their part numbers are listed below.

- **CAT460** Antenna: AY139X001
- **VOL** Knob: RA1193900
- **MIC/SP** Rubber Cap: RA1194200
- **MIC/SP** Plastic Cap: RA057790A
- **CLIP-920** Belt Clip: AAE51X001

## 8.3 FACTORY SERVICE

In the unlikely event that the radio fails to perform or needs servicing, please contact the following:

### *For repairs In USA*

#### **Standard Horizon**

Attention Marine Repair Department  
6125 Phyllis Drive, Cypress, CA 90630  
Telephone (800) 366-4566





### *For repairs In Canada*

#### **Westcom Marine**

488 East 62 nd Avenue  
Vancouver BC V5X2G1  
Telephone (604) 327-6280

An "RA" Return Authorization number is not necessary to send a product in for service. Include a brief note describing the problem along with your name, return address, phone number, and proof of purchase.

## 8.4 TROUBLESHOOTING CHART

SYMPTOM	PROBABLE CAUSE	REMEDY
The  key does not start the scan.	No channels memorized.	Use the  key to enter desired channels into the Preset memory.
	Squelch is not adjusted.	Adjust the squelch to threshold or to the point where noise just disappears. Further adjustment of the squelch control may eliminate incoming signals.
Cannot select between USA, INTL, or Canadian bands.	Proper operation not followed.	HOLD down the  key and press the  key.
Speaker audio is not heard when the  key is pressed and held.	Low battery.	Charge battery. Refer to section 4.3.3 of this manual.
	Audio volume level is too low.	Turn the <b>VOL</b> knob clockwise.
Some keys do not operate.	Key Lock is on.	Turn the Key Lock off. Refer to section 6.6 of this manual.
Charging indicator on <b>CD-48</b> does not illuminate.	<ul style="list-style-type: none"> <li>• Defective battery <b>FNB-V105LI</b>.</li> <li>• Battery contacts not making contact with the charger cradle.</li> </ul>	Contact Standard Horizon Product Support at (800)767-2450.

## 9. VHF MARINE CHANNEL ASSIGNMENTS

Tables on the following pages list the VHF Marine Channel assignments for U.S.A. and International use. Below are listed some data about the charts.

1. VTS. Where indicated, these channels are part of the U.S. Coast Guard's Vessel Traffic System.
2. Alpha channel numbers, that is, channel numbers followed by the letter A (such as Channel 07**A**) are **simplex** channels on the U.S.A. or Canadian channel assignments whose counterparts in the International assignments are **duplex** channels. International channels do not use "alpha" numbers. If you call the Coast Guard on Channel 16, they will sometimes ask you to "**go to channel 22 Alpha**." This is a channel assigned to U.S.A, and Canadian Coast Guards for handling distress and other calls. If your radio is set for **International** operation you will go to Channel 22 instead of 22**A**, and will not be able to communicate with the Coast Guard. To use Channel 22**A**, your radio must be set for **USA** or **Canada** operation, usually by a U/I/C (USA/International/Canada) control or combination of controls. Channel 22 (without an "A") is an **International** duplex channel for port operations. Some radios indicate an "A" adjacent to the alpha channels on the display; on others "alpha" is not indicated but the proper channel is selected based on the U/I/C setting.
3. Bridge-to-Bridge channels (for example, Channel 13) are for use by bridge operators on inter-coastal waterways and rivers. It is also used by marine vessels in the vicinity of these bridges for navigation and for communicating with the bridge operators. Note that a limit of 1 Watt is specified for these channels.
4. The **S/D** column on the chart indicates either S (simplex) or D (duplex). **Simplex** means transmitting and receiving on the same frequency. Only one party at a time can talk, unlike a telephone. Be sure to say "**over**" and release your microphone push-to-talk switch at the end of each transmission. **Duplex** operation involves the use of one frequency for transmitting and a separate frequency for receiving. On channels specified as duplex on the charts, correct mode of operation is established automatically by your radio when you select a channel; you cannot change the mode. And you still must release the push-to-talk switch after each transmission in order to listen to the radio.
5. Channels normally used by recreational boaters are those that include the term "non-commercial" in the **Channel Use** column of the chart. Some of these are shared with other users and some are used only in certain geographic regions.
6. Marine vessels equipped with VHF radios are required to monitor Channel 16.



VHF MARINE CHANNEL CHART							
CH	U	C	I	S/D	TX	RX	CHANNEL USE
01		X	X	D	156.050	160.650	Public Correspondence (Marine Operator)
01A	X			S	156.050		Port Operation and Commercial. VTS in selected areas
02		X	X	D	156.100	160.700	Public Correspondence (Marine Operator)
03		X	X	D	156.150	160.750	Public Correspondence (Marine Operator)
03A	<b>X</b>			<b>S</b>	<b>156.150</b>		<b>U.S. Government Only, Coast Guard</b>
04			X	D	156.200	160.800	Public Correspondence (Marine Operator), Port operation, ship movement
04A		X		S	156.200		Pacific coast: Coast Guard, East Coast: Commercial fishing
05			X	D	156.250	160.850	Public Correspondence (Marine Operator), Port operation, ship movement
05A	X	X		S	156.250		Port operation. VTS in Seattle
06	X	X	X	S	156.300		Inter-ship Safety
07			X	D	156.350	160.950	Public Correspondence (Marine Operator), Port operation, ship movement
07A	X	X		S	156.350		Commercial
08	X	X	X	S	156.400		Commercial (Inter-ship only)
09	X	X	X	S	156.450		Boater Calling channel, Commercial & Non-commercial (Recreational)
10	X	X	X	S	156.500		Commercial
11	X	X	X	S	156.550		Commercial. VTS in selected areas.
12	X	X	X	S	156.600		Port operation. VTS in selected areas.
13	X	X	X	S	156.650		Inter-ship Navigation Safety (Bridge-to-bridge)
14	X	X	X	S	156.700		Port operation. VTS in selected areas.
15	X			S	---	156.750	Environmental (Receive only)
15		X	X	S	156.750		Commercial, non-commercial, ship movement (1 W)
16	X	X	X	S	156.800		International Distress, Safety and Calling
17	X	X	X	S	156.850		State Controlled (1 W)
18			X	D	156.900	161.500	Port operation, ship movement
18A	X	X		S	156.900		Commercial
19			X	D	156.950	161.550	Port operation, ship movement
19A	X			S	156.950		US: Commercial
19A		X		S	156.950		Coast Guard
20	X	X	X	D	157.000	161.600	Canadian Coast Guard Only, International: port operations and shipment
20A	X			S	157.000		Port operation
21			X	D	157.050	161.650	Port operation, ship movement
<b>21A</b>	<b>X</b>	<b>X</b>		<b>S</b>	<b>157.050</b>		<b>U.S. Government Only, Canadian Coast Guard</b>
21B		X			---	161.650	CMB Service
22			X	D	157.100	161.700	Port operation, ship movement
22A	X	X		S	157.100		US and Canadian Coast Guard Liaison and Maritime Safety Information Broadcasts announced on channel 16
23		X	X	D	157.150	161.750	Public Correspondence (Marine Operator)
<b>23A</b>	<b>X</b>			<b>S</b>	<b>157.150</b>		<b>U.S. Government Only</b>
23B		X			---	161.75	CMB Service
24	X	X	X	D	157.200	161.800	Public Correspondence (Marine Operator)
25	X	X	X	D	157.250	161.850	Public Correspondence (Marine Operator)
25B		X			---	161.850	CMB Service

VHF MARINE CHANNEL CHART							
CH	U	C	I	S/D	TX	RX	CHANNEL USE
26	X	X	X	D	157.300	161.900	Public Correspondence (Marine Operator)
27	X	X	X	D	157.350	161.950	Public Correspondence (Marine Operator)
28	X	X	X	D	157.400	162.000	Public Correspondence (Marine Operator)
28B		X			---	162.000	CMB Service
60		X	X	D	156.025	160.625	Public Correspondence (Marine Operator)
61			X	D	156.075	160.675	Public Correspondence (Marine Operator), Port operation, ship movement
<b>61A</b>	<b>X</b>	<b>X</b>		<b>S</b>	<b>156.075</b>		<b>Public Coast: Coast Guard; East Coast: commercial fishing only</b>
62			X	D	156.125	160.725	Public Correspondence (Marine Operator), Port operation, ship movement
62A		X		S	156.125		Public Coast: Coast Guard; East Coast: commercial fishing only
63			X	D	156.175	160.775	Public Correspondence (Marine Operator), Port operation, ship movement
63A	X	X		S	156.175		Port Operation and Commercial. VTS in selected areas.
64		X	X	D	156.225	160.825	Public Correspondence (Marine Operator), Port operation, ship movement
<b>64A</b>	<b>X</b>	<b>X</b>		<b>S</b>	<b>156.225</b>		<b>Public Correspondence (Marine Operator), Port operation, ship movement</b>
65			X	D	156.275	160.875	Public Correspondence (Marine Operator), Port operation, ship movement
65A	X	X		S	156.275		Port Operations
66			X	D	156.325	160.925	Public Correspondence (Marine Operator), Port operation, ship movement
66A	X	X		S	156.325		Port Operations
67	X	X	X	S	156.375		US: Commercial. Used for Bridge-to-bridge communications in lower Mississippi River. Inter-ship only. Canada: Commercial fishing, S&R
68	X	X	X	S	156.425		Non-commercial (Recreational)
69	X	X	X	S	156.475		US: Non-commercial (Recreational), Canada: Commercial fishing only, International: Inter-ship, Port operations and Ship movement
70	X	X	X	S	156.525		Digital selective calling (voice communica- tions not allowed)
71	X	X	X	S	156.575		US, Canada: Non-commercial (Recreational), International: Port operations and Ship movement
72	X	X	X	S	156.625		Non-commercial (Inter-ship only)
73	X	X	X	S	156.675		US: Port Operations, Canada: Commercial fishing only, International: Inter-ship, Port operations and Ship movement
74	X	X	X	S	156.725		US: Port Operations, Canada: Commercial fishing only, International: Inter-ship, Port operations and Ship movement
75	X	X	X	S	156.775		Port Operations (Inter-ship only) (1W)
76	X	X	X	S	156.825		Port Operations (Inter-ship only) (1W)
77	X	X		S	156.875		Port Operations (Inter-ship only) (1W)

VHF MARINE CHANNEL CHART								
CH	U	C	I	S/D	TX		RX	CHANNEL USE
77			X	S	156.875			Port Operations (Inter-ship only)
78			X	D	156.925	161.525		Public Correspondence (Marine Operator), Port operation, ship-movement
78A	X	X		S	156.925			Non-commercial (Recreational)
79			X	D	156.975	161.575		Port operation and Ship movement
79A	X	X		S	156.975			Commercial
80			X	D	157.025	161.625		Port operation, ship movement
80A	X	X		S	157.025			Commercial
81			X	D	157.075	161.675		Port operation, ship movement
<b>81A</b>	<b>X</b>			<b>S</b>	<b>157.075</b>			<b>U.S. Government Only - Environmental protection operations.</b>
81A		X		S	157.075			Canadian Coast Guard Only
82			X	D	157.125	161.725		Public Correspondence (Marine Operator), Port operation, ship movement
<b>82A</b>	<b>X</b>	<b>X</b>		<b>S</b>	<b>157.125</b>			<b>U.S. Government Only, Canadian Coast Guard Only</b>
83		X		D	157.175	161.775		Canadian Coast Guard Only
83			X	D	157.175	161.775		Public Correspondence (Marine Operator)
<b>83A</b>	<b>X</b>	<b>X</b>		<b>S</b>	<b>157.175</b>			<b>U.S. Government Only, Canadian Coast Guard Only</b>
83B		X			---	161.775		CMB Service
84	X	X	X	D	157.225	161.825		Public Correspondence (Marine Operator)
85	X	X	X	D	157.275	161.875		Public Correspondence (Marine Operator)
86	X	X	X	D	157.325	161.925		Public Correspondence (Marine Operator)
87		X	X	S	157.375			Port operation, ship movement
87A	X			S	157.375			Public Correspondence (Marine Operator)
88		X	X	S	157.425			Port operation, ship movement
88A	X			S	157.425			Commercial, Inter-ship Only

**NOTE:** Simplex channels, 3A, 21A, 23A, 61A, 64A, 81A, 82A and 83A CANNOT be lawfully used by the general public in U.S.A. waters.

## 10. WARRANTY

### Marine Products Limited Warranty

#### PLEASE NOTE

**The following “Limited Warranty” is for valid for products that have been purchased in the United States and Canada. For limited Warranty details outside the United States, contact the dealer in your country.**

STANDARD HORIZON (a division of YAESU U.S.A.) warrants, to the original purchaser only, each new Marine Communications Product (“Product”) manufactured and/or supplied by STANDARD HORIZON against defects in materials and workmanship under normal use and service for a period of time from the date of purchase as follows:

#### **Fixed Mount and Portable Transceivers**

**1 year - if purchased before 01/01/91**

**3 years - if purchased between 01/01/91 and 01/01/94**

**3 years Waterproof - if purchased after 01/01/94**

#### **Loud hailers**

**1 year - if purchased before 01/01/91**

**3 years - if purchased after 01/01/91**

#### **Associated Chargers**

**1 year - if purchased before 01/01/91**

**3 years - if purchased after 01/01/91**

**Associated Batteries** - 1 year. Note: Batteries will be deemed defective only if storage capacity drops below 80% of rated capacity or if leakage develops.

**Associated Accessories** - 1 year. Includes: Microphones/Handsets, External Speakers, Antennas, Carrying Accessories, Power Supplies, and Signaling Boards.

To receive warranty service, the purchaser must deliver the Product, transportation and insurance prepaid, to STANDARD HORIZON (a division of YAESU U.S.A.), Attention Marine repairs 6125 Phyllis Drive, Cypress, CA 90630. Include proof of purchase indicating model, serial number, and date of purchase. STANDARD HORIZON will return the Product to the purchaser freight prepaid. Products purchased prior to January 1, 1991 will bear the STANDARD HORIZON warranty terms in effect prior to that date.

In the event of a defect, malfunction or failure of the Product during the warranty period, STANDARD HORIZON's liability for any breach of contract or any breach of express or implied warranties in connection with the sale of Products shall be limited solely to repair or replacement, at its option, of the

Product or part(s) therein which, upon examination by STANDARD HORIZON, appear to be defective or not up to factory specifications. STANDARD HORIZON may, at its option, repair or replace parts or subassemblies with new or reconditioned parts and subassemblies. Parts thus repaired or replaced are warranted for the balance of the original applicable warranty.

STANDARD HORIZON will not warrant installation, maintenance or service of the Products. In all instances, STANDARD HORIZON's liability for damages shall not exceed the purchase price of the defective Product.

This warranty only extends to Products sold within the 50 States of the United States of America and the District of Columbia.

STANDARD HORIZON will pay all labor to repair the product and replacement parts charges incurred in providing the warranty service except where purchaser abuse or other qualifying exceptions exist. The purchaser must pay any transportation expenses incurred in returning the Product to STANDARD HORIZON for service.

This limited warranty does not extend to any Product which has been subjected to misuse, neglect, accident, incorrect wiring by anyone other than STANDARD HORIZON, improper installation, or subjected to use in violation of instructions furnished by STANDARD HORIZON, nor does this warranty extend to Products on which the serial number has been removed, defaced, or changed. STANDARD HORIZON cannot be responsible in any way for ancillary equipment not furnished by STANDARD HORIZON which is attached to or used in connection with STANDARD HORIZON's Products, or for the operation of the Product with any ancillary equipment, and all such equipment is expressly excluded from this warranty. STANDARD HORIZON disclaims liability for range, coverage, or operation of the Product and ancillary equipment as a whole under this warranty. STANDARD HORIZON reserves the right to make changes or improvements in Products, during subsequent production, without incurring the obligation to install such changes or improvements on previously manufactured Products.

The implied warranties which the law imposes on the sale of this Product are expressly LIMITED, in duration, to the time period specified above. STANDARD HORIZON shall not be liable under any circumstances for consequential damages resulting from the use and operation of this Product, or from the breach of this LIMITED WARRANTY, any implied warranties, or any contract with STANDARD HORIZON. IN CONNECTION WITH THE SALE OF ITS PRODUCTS, STANDARD HORIZON MAKES NO WARRANTIES, EXPRESS OR IMPLIED AS TO THE MERCHANTABILITY OR FITNESS FOR A PARTICULAR PURPOSE OR OTHERWISE, EXCEPT AS EXPRESSLY SET FORTH HEREIN.

Some states do not allow the exclusion or limitation of incidental or consequential damages, or limitation on how long an implied warranty lasts, so the above limitations or exclusions may not apply. This warranty gives specific legal rights, and there may be other rights which may vary from state to state.

ONLY PRODUCTS SOLD ON OR AFTER JANUARY 1, 1991 ARE COVERED UNDER THE TERMS OF THIS LIMITED WARRANTY.

## ON-LINE WARRANTY REGISTRATION

THANK YOU for purchasing a Standard Horizon products! We are confident your new radio will serve your needs for many years!

Please visit [www.standardhorizon.com](http://www.standardhorizon.com) to register the **HX380** Marine VHF. It should be noted that visiting the Web site from time to time may be beneficial to you, as new products are released they will appear on the STANDARD HORIZON Web site. Also a statement regarding product support should be added to the manual.

### Product Support Inquiries

If you have any questions or comments regarding the use of the **HX380**, you can visit the STANDARD HORIZON Web site to send an E-Mail or contact the Product Support team at (800) 767-2450 M-F 8:00AM to 5:00PM PST.

In addition to the warranty, STANDARD HORIZON includes a lifetime "flat rate" and "customer loyalty" programs to provide service after the warranty period has expired. If you wish to obtain the flat rate price for out-of-warranty repair, you must include the information on the Owner's Record with the unit when you return it to your Dealer or to STANDARD HORIZON.

Lifetime Flat Rate Service Program: For the original Owner only, for the lifetime of the unit, STANDARD HORIZON will repair the unit to original specifications.

Note: The flat rate amount is payable by the Owner only if STANDARD HORIZON or the STANDARD HORIZON Dealer determines that a repair is needed. After the repair, a 90-day warranty will be in effect from the date of return of the unit to the Owner.

This service program is not available for equipment which has failed as a result of neglect, accident, breakage, misuse, improper installation or modification, or water damage (depending on the product).

## 11. INSTALLATION OF OPTION

### 11.1 FBA-40 ALKALINE BATTERY TRAY

**FBA-40** is a battery tray that holds six AA size Alkaline batteries and is used with the **HX380** transceiver. When the **FBA-40** is installed into the **HX380** the radio can withstand immersion in water up to 1.5 m (about 5Ft) for 30 minutes.

1. On the **FBA-40**, remove the battery case cover. Due to the battery case water proof characteristics, it may be difficult to remove the battery tray case, put a coin to the edge of the battery compartment (  ) then pry open the battery case cover.
2. Slide the six AA size Alkaline batteries into the **FBA-40** Battery Case with the Negative (-) side of the batteries touching the spring connections inside the **FBA-40** Battery Case.
3. Attach the battery cover to the **FBA-40** Battery Case while being careful so that o-ring is not twisted.
4. Insert the **FBA-40** Battery Case into the battery compartment on the back of the **HX380** transceiver while tilting the Belt Clip outward, then push the bottom side of the **FBA-40** Battery Case until the Battery Case locks with the Battery Pack Latch.

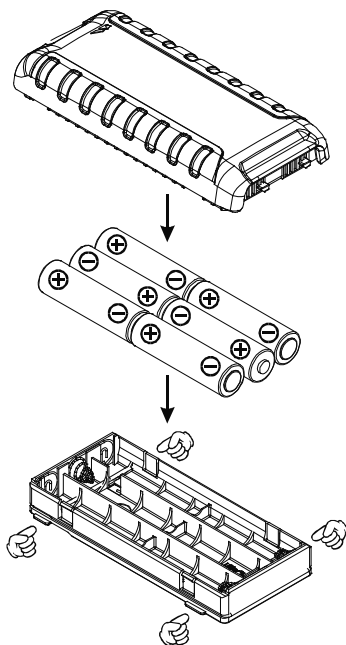

## 12. SPECIFICATIONS

Performance specifications are nominal, unless otherwise indicated, and are subject to change without notice.

### 12.1 GENERAL

<b>Frequency Ranges:</b>	156.025 MHz - 163.275 MHz (Marine Band + WX Band) 134.000 MHz - 174.000 MHz (LMR Band)
<b>Channel Spacing:</b>	25 kHz / 12.5 kHz
<b>Frequency Stability:</b>	±2.5 ppm (-22 °F to +140 °F [-30 °C to +60 °C])
<b>Emission Type:</b>	16K0G3E (Marine Band) 16K0F3E (LMR Band: Wide) 11K0F3E (LMR Band: Narrow)
<b>Antenna Impedance:</b>	50 Ω
<b>Supply Voltage:</b>	7.4V DC, Negative Ground (Battery Terminal)
<b>Current Consumption:</b>	320 mA (Receive, Typical at AF MAX.) 50 mA (Standby) 1.6 A / 0.8 A (TX: 5 W / 1W)
<b>Operating Temperature:</b>	-22 °F to +140 °F (-30 °C to +60 °C)
<b>Case Size (W x H x D):</b>	2.24" x 5.24" x 1.29" (57 x 133 x 33 mm) w/o knob & antenna
<b>Weight (Approx.):</b>	11.3 oz (320 g) w/FNB-V105LI, Belt Clip, & Antenna

### 12.2 TRANSMITTER

<b>RF Power Output:</b>	5 W / 1 W (@7.4 V )
<b>Modulation Type:</b>	Variable Reactance
<b>Maximum Deviation:</b>	±5.0 kHz (Wide) / ±2.5 kHz (Narrow)
<b>Spurious Emission:</b>	-36 dBm (<1 GHz), -30 dBm (>1 GHz)
<b>Microphone Impedance:</b>	2 kΩ



## 12.3 RECEIVER

<b>Circuit Type:</b>	Double-Conversion Superheterodyne
<b>Intermediate Frequencies:</b>	1st: 67.65 MHz, 2nd: 450 kHz
<b>Adjacent Channel Selectivity:</b>	70 dB typical (Wide), 60 dB typical (Narrow)
<b>Intermodulation:</b>	59 dB typical
<b>Sensitivity:</b>	-6 dB $\mu$ V (0.25 $\mu$ V) for 12 dB SINAD
<b>Selectivity (Wide):</b>	12 kHz / 25 kHz (-6 dB / -60 dB)
<b>Selectivity (Narrow):</b>	6 kHz / 18 kHz (-6 dB / -60 dB)
<b>AF Output (Internal SP):</b>	700 mW @16 $\Omega$ for 10 % THD (@7.4 V)
<b>AF Output (External SP):</b>	350 mW @8 $\Omega$ for 10 % THD (@7.4 V)

*Measured in accordance with TIA/EIA-603.*

# **FCC AND CANADA RADIO LICENSE INFORMATION**

Standard Horizon radios comply with the Federal Communication Commission (FCC) and Industry-Canada requirements that regulate the Maritime Radio Service.

## **MARITIME STATION LICENSE**

An FCC ship station license is no longer required for any vessel traveling in U.S. waters which uses a VHF marine radio, RADAR or EPIRB, and which is not required to carry radio equipment. However, any vessel required to carry a marine radio on an international voyage, carrying a HF single side band radiotelephone or marine satellite terminal. FCC license forms, including applications for ship (605) and land station licenses can be downloaded via the Internet at [www.fcc.gov/Forms/Form605/605.html](http://www.fcc.gov/Forms/Form605/605.html). To obtain a form from the FCC, call (888) 225-5322.

## **MARINE RADIO CALL SIGN**

Currently the FCC does not require recreational boaters to have a Ship Radio Station License. The USCG recommends the boats registration number and the state to be used.

## **CANADIAN SHIP STATION LICENSING**

You may need a license when traveling in Canada. If you do need a license contact their nearest field office or regional office or write:

**Industry Canada  
Radio Regulatory Branch  
Attn: DOSP  
300 Slater Street  
Ottawa, Ontario  
Canada, KIA 0C8**

## **FCC/INDUSTRY CANADA INFORMATION**

The following data pertaining to the transceiver is necessary to fill out the license application.

FCC Type Accepted:	.....Part 80 / Part 90
Output Power with FNB-V105LI:	..... 1.0/5.0 W (Low/High)
Emission:	..... 16K0G3E (Marine Band) 16K0F3E, 11K0F3E (LMR Band)
Frequency Range:	..... 156.025 to 163.275MHz (Marine Band) 134.000 to 174.000 MHz (LMR Band)
FCC Type Number:	..... K6630393X20
Industry Canada Type Approval:	..... 511B-30393X20

THIS DEVICE COMPLIES WITH PART 15 OF THE FCC RULES. OPERATION IS SUBJECT TO THE FOLLOWING TWO CONDITIONS: (1) THIS DEVICE MAY NOT CAUSE HARMFUL INTERFERENCE, AND (2) THIS DEVICE MUST ACCEPT ANY INTERFERENCE RECEIVED, INCLUDING INTERFERENCE THAT MAY CAUSE UNDESIRE OPERATION.

Changes or modifications to this device not expressly approved by YAESU U.S.A. could void the User's authorization to operate this device.

This device complies with Industry Canada license-exempt RSS standard(s). Operation is subject to the following two conditions: (1) this device may not cause interference, and (2) this device must accept any interference, including interference that may cause undesired operation of the device.

---

Le présent appareil est conforme aux CNR d'Industrie Canada applicables aux appareils radio exempts de licence. L'exploitation est autorisée aux deux conditions suivantes : (1) l'appareil ne doit pas produire de brouillage, et (2) l'utilisateur de l'appareil doit accepter tout brouillage radioélectrique subi, même si le brouillage est susceptible d'en compromettre le fonctionnement.

---

Under Industry Canada regulations, this radio transmitter may only operate using an antenna of a type and maximum (or lesser) gain approved for the transmitter by Industry Canada. To reduce potential radio interference to other users, the antenna type and its gain should be so chosen that the equivalent isotropically radiated power (e.i.r.p.) is not more than that necessary for successful communication.

---

Conformément à la réglementation d'Industrie Canada, le présent émetteur radio peut fonctionner avec une antenne d'un type et d'un gain maximal (ou inférieur) approuvé pour l'émetteur par Industrie Canada. Dans le but de réduire les risques de brouillage radioélectrique à l'intention des autres utilisateurs, il faut choisir le type d'antenne et son gain de sorte que la puissance isotrope rayonnée équivalente (p.i.r.e.) ne dépasse pas l'intensité nécessaire à l'établissement d'une communication satisfaisante.

---

This radio transmitter (identify the device by certification number, or model number if Category II) has been approved by Industry Canada to operate with the antenna types listed below with the maximum permissible gain and required antenna impedance for each antenna type indicated. Antenna types not included in this list, having a gain greater than the maximum gain indicated for that type, are strictly prohibited for use with this device.

---

Le présent émetteur radio (identifier le dispositif par son numéro de certification ou son numéro de modèle s'il fait partie du matériel de catégorie I) a été approuvé par Industrie Canada pour fonctionner avec les types d'antenne énumérés ci-dessous et ayant un gain admissible maximal et l'impédance requise pour chaque type d'antenne. Les types d'antenne non inclus dans cette liste, ou dont le gain est supérieur au gain maximal indiqué, sont strictement interdits pour l'exploitation de l'émetteur. l'établissement d'une communication satisfaisante.

## ***STANDARD HORIZON***

*Nothing takes to water like Standard Horizon*

Copyright 2015  
YAESU MUSEN CO., LTD.  
All rights reserved.

No portion of this manual may be  
reproduced without the permission of  
YAESU MUSEN CO., LTD.

**YAESU USA**  
6125 Phyllis Drive, Cypress, CA 90630

1512U-AO

Printed in Japan



E M O 3 9 N 2 1 2