

# VMH 70 MARINE DISPLAY

USER MANUAL  
rev. AD

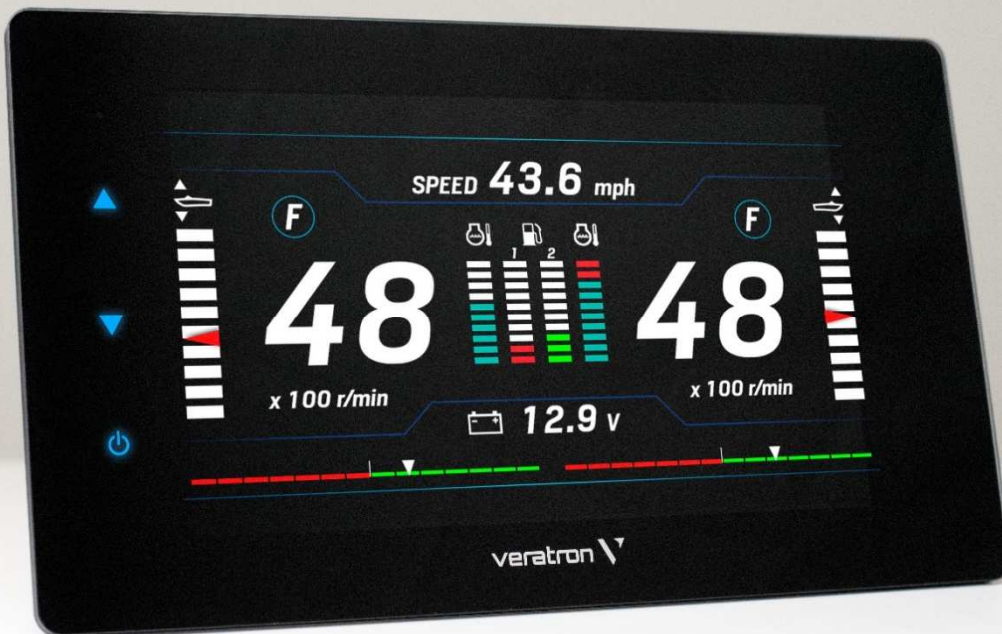

EN

DE

IT

FR

ES

| <b>LANGUAGE</b> | <b>PAGE</b> |
|-----------------|-------------|
| ENGLISH         | 3           |
| DEUTSCH         | 47          |
| ITALIANO        | 93          |

# VMH 70 MARINE DISPLAY

USER MANUAL  
rev. AD

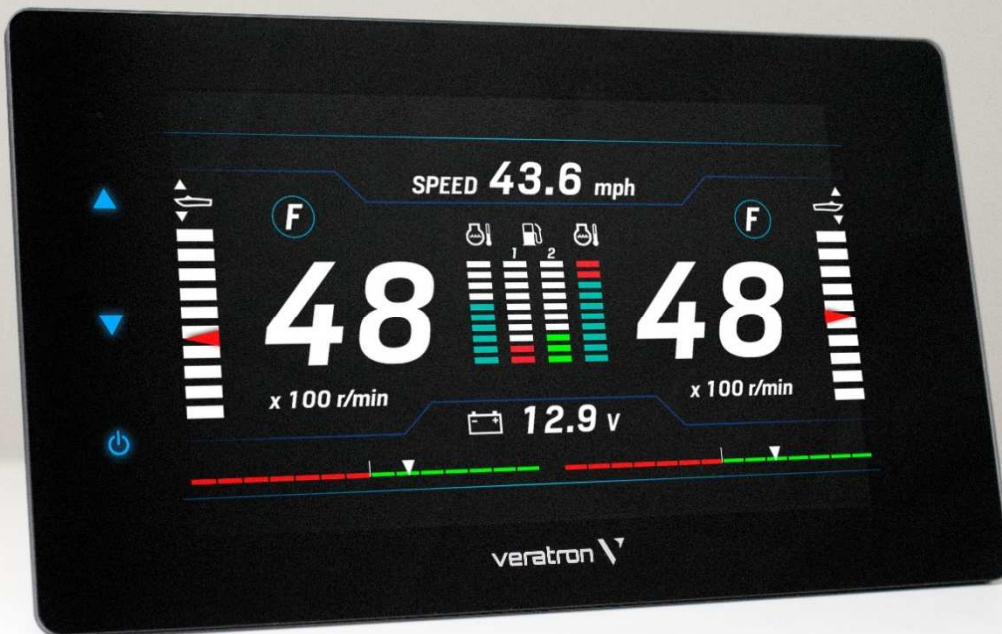

EN

DE

IT

FR

ES

# TABLE OF CONTENTS

|  |           |   |           |
|--|-----------|---|-----------|
| <b>INTRODUCTION</b> .....                  | <b>3</b>  | Engine Hours .....                          | 22        |
| Architecture.....                          | 3         | Distance Traveled.....                      | 22        |
| <b>SAFETY INFORMATION</b> .....            | <b>4</b>  | NavDash Layout.....                         | 23        |
| Safety during Installation.....            | 4         | <b>SCREENS CONFIGURATION</b> .....          | <b>24</b> |
| Safety after Installation.....             | 5         | <b>SYSTEM CONFIGURATION</b> .....           | <b>26</b> |
| Electrical Connection .....                | 5         | Menu Structure .....                        | 26        |
| <b>INSTALLATION</b> .....                  | <b>6</b>  | Operating the System Config Menu .....      | 27        |
| Before the Assembly .....                  | 6         | Units .....                                 | 29        |
| Panel Mounting .....                       | 7         | SAE J1939 Gateway.....                      | 29        |
| <b>ELECTRICAL CONNECTIONS</b> .....        | <b>9</b>  | <b>SENSOR CONFIGURATION</b> .....           | <b>30</b> |
| Engine 1 Connector [A] .....               | 9         | Menu Structure .....                        | 30        |
| Engine 2 Connector [B] .....               | 10        | Configure a Sensor Connected to the Display | 31        |
| EasyLink Connectors [C].....               | 10        | Fuel Level Sensor Calibration.....          | 33        |
| NMEA 2000® Connector [D].....              | 11        | Other Sensors' Calibration.....             | 33        |
| Video Input Connector [E] .....            | 11        | Custom Sensors Configuration .....          | 34        |
| Electrical Schematic .....                 | 12        | Default Calibrations .....                  | 35        |
| RPM Sensor Connection .....                | 13        | Adjusting the Speed Correction Factor ..... | 35        |
| Resistive Sensor Connection.....           | 14        | <b>ALARMS</b> .....                         | <b>36</b> |
| External Buzzer Connection (B1).....       | 14        | Menu Structure .....                        | 36        |
| Day / Night Mode Selector Switch (S1)..... | 14        | Alarms Notification .....                   | 36        |
| Priority of Recieved Signals.....          | 15        | Acknowledge an Alarm.....                   | 37        |
| <b>GETTING STARTED</b> .....               | <b>16</b> | Active Alarms.....                          | 37        |
| Operational Concept.....                   | 16        | Configure a Local Alarm.....                | 38        |
| Standby Mode .....                         | 16        | Configure a CAN Alarm.....                  | 39        |
| Switching ON and OFF .....                 | 16        | <b>TROUBLESHOOTING</b> .....                | <b>40</b> |
| Menu Button Functions.....                 | 17        | <b>TECHNICAL DATA</b> .....                 | <b>41</b> |
| Touch Button Functions.....                | 17        | General Feature .....                       | 41        |
| Calibration Wizard.....                    | 17        | Environmental Features.....                 | 41        |
| Set the Day/Night Mode .....               | 18        | Electrical Features .....                   | 41        |
| Startup Checklist.....                     | 18        | Compliance .....                            | 42        |
| Upload a Custom Splash Logo .....          | 18        | Supported NMEA 2000 Messages .....          | 42        |
| <b>DATA SCREENS</b> .....                  | <b>19</b> | Disposal Responsibility .....               | 42        |
| Screens Scrolling .....                    | 19        | <b>SPARE PARTS AND ACCESSORIES</b> .....    | <b>43</b> |
| Screen Layouts.....                        | 19        |   |           |
| Supported Data.....                        | 21        |   |           |

# INTRODUCTION

The VMH 70 is a multifunctional display designed to monitor your boat engines and navigation. Up to four engines can be monitored with a single display.

The integrated NMEA 2000 gateway lets you acquire engine data also via analog sensors or SAE J1939, to then convert and distribute them on the NMEA 2000 network.

The display manages up to six resistive sensors, three voltage sensors and one digital alarm.

All data are also distributed on two EasyLink channels to a maximum of 16 VMH 14 gauges per channel. NMEA 2000 connectivity lets you view navigation data from other devices on the network, such as wind, compass, GPS, speed, and depth data.



## ARCHITECTURE

Following is an example of an application with a VMH 70 display, used as a gateway and as a NMEA 2000 monitor.

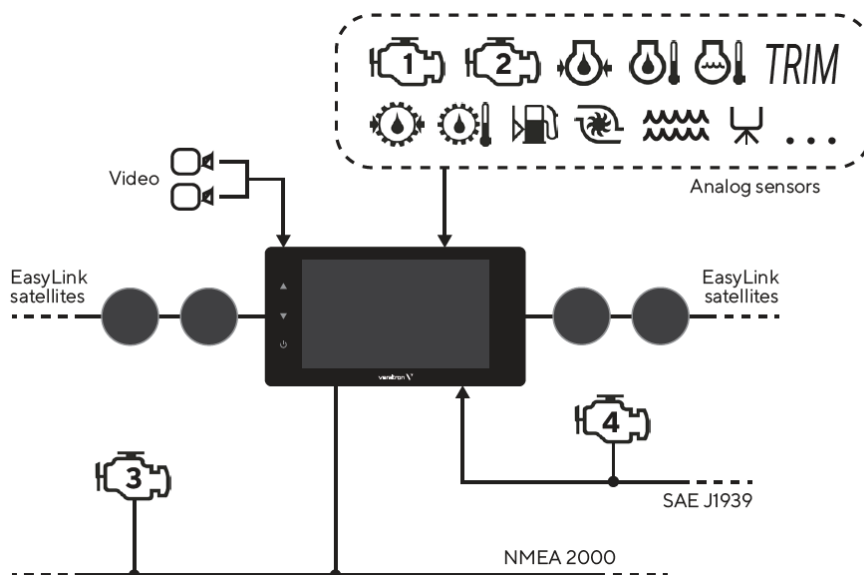

# SAFETY INFORMATION

## WARNING

- No smoking! No open fire or heat sources!
- The product was developed, manufactured and inspected according to the basic safety requirements of EC Guidelines and state-of-the-art technology.
- The instrument is designed for use in grounded vehicles and machines as well as in pleasure boats, including non-classified commercial shipping.
- Use our product only as intended. Use of the product for reasons other than its intended use may lead to personal injury, property damage or environmental damage. Before installation, check the vehicle documentation for vehicle type and any possible special features!
- Use the assembly plan to learn the location of the fuel/hydraulic/compressed air and electrical lines!
- Note possible modifications to the vehicle, which must be considered during installation!
- To prevent personal injury, property damage or environmental damage, basic knowledge of motor vehicle/shipbuilding electronics and mechanics is required.
- Make sure that the engine cannot start unintentionally during installation!
- Modifications or manipulations to Veratron products can affect safety. Consequently, you may not modify or manipulate the product!
- When removing/installing seats, covers, etc., ensure that lines are not damaged and plug-in connections are not loosened!
- Note all data from other installed instruments with volatile electronic memories.

## SAFETY DURING INSTALLATION

- During installation, ensure that the product's components do not affect or limit vehicle functions. Avoid damaging these components!
- Only install undamaged parts in a vehicle!
- During installation, ensure that the product does not impair the field of vision and that it cannot impact the driver's or passenger's head!
- A specialized technician should install the product. If you install the product yourself, wear appropriate work clothing. Do not wear loose clothing, as it may get caught in moving parts. Protect long hair with a hair net.
- When working on the on-board electronics, do not wear metallic or conductive jewelry such as necklaces, bracelets, rings, etc.
- If work on a running engine is required, exercise extreme caution. Wear only appropriate work clothing as you are at risk of personal injury, resulting from being crushed or burned.
- Before beginning, disconnect the negative terminal on the battery, otherwise you risk a short circuit. If the vehicle is supplied by auxiliary batteries, you must also disconnect the negative terminals on these batteries! Short circuits can cause fires, battery explosions and damages to other electronic systems. Please note that when you disconnect the battery, all volatile electronic memories lose their input values and must be reprogrammed.
- If working on gasoline boat motors, let the motor compartment fan run before beginning work.
- Pay attention to how lines and cable harnesses are laid so that you do not drill or saw through them!
- Do not install the product in the mechanical and electrical airbag area!
- Do not drill holes or ports in load-bearing or stabilizing stays or tie bars!
- When working underneath the vehicle, secure it according to the specifications from the vehicle manufacturer.
- Note the necessary clearance behind the drill hole or port at the installation location. Required mounting depth: 65 mm.

## **SAFETY INFORMATION**

- Drill small ports; enlarge and complete them, if necessary, using taper milling tools, saber saws, keyhole saws or files. Deburr edges. Follow the safety instructions of the tool manufacturer.
- Use only insulated tools, if work is necessary on live parts.
- Use only the multimeter or diode test lamps provided, to measure voltages and currents in the vehicle/machine or boat. Use of conventional test lamps can cause damage to control units or other electronic systems.
- The electrical indicator outputs and cables connected to them must be protected from direct contact and damage. The cables in use must have enough insulation and electric strength and the contact points must be safe from touch.
- Use appropriate measures to also protect the electrically conductive parts on the connected consumer from direct contact. Laying metallic, uninsulated cables and contacts is prohibited.

## **SAFETY AFTER INSTALLATION**

- Connect the ground cable tightly to the negative terminal of the battery.
- Reenter/reprogram the volatile electronic memory values.
- Check all functions.
- Use only clean water to clean the components. Note the Ingress Protection (IP) ratings (IEC 60529).

## **ELECTRICAL CONNECTION**

- Note cable cross-sectional area!
- Reducing the cable cross-sectional area leads to higher current density, which can cause the cable cross-sectional area in question to heat up!
- When installing electrical cables, use the provided cable ducts and harnesses; however, do not run cables parallel to ignition cables or to cables that lead to large electricity consumers.
- Fasten cables with cable ties or adhesive tape. Do not run cables over moving parts. Do not attach cables to the steering column!
- Ensure that cables are not subject to tensile, compressive or shearing forces.
- If cables are run through drill holes, protect them using rubber sleeves or the like.
- Use only one cable stripper to strip the cable. Adjust the stripper so that stranded wires are not damaged or separated.
- Use only a soft soldering process or commercially available crimp connector to solder new cable connections!
- Make crimp connections with cable crimping pliers only. Follow the safety instructions of the tool manufacturer.
- Insulate exposed stranded wires to prevent short circuits.
- Caution: Risk of short circuit if junctions are faulty or cables are damaged.
- Short circuits in the vehicle network can cause fires, battery explosions and damages to other electronic systems. Consequently, all power supply cable connections must be provided with weldable connectors and be sufficiently insulated.
- Ensure ground connections are sound.
- Faulty connections can cause short circuits. Only connect cables according to the electrical wiring diagram.
- If operating the instrument on power supply units, note that the power supply unit must be stabilized and it must comply with the following standard: DIN EN 61000, Parts 6-1 to 6-4.

# INSTALLATION

## ⚠ WARNING

Before starting work, disconnect the negative terminal of the battery to avoid the risk of a short circuit. If the vehicle is equipped with additional batteries, the negative terminal of all batteries must also be disconnected if necessary. Short circuits can burn cables, explode batteries and cause damage to other electronic systems. Remember that by disconnecting the battery, all data entered in the temporary electronic memory will be lost and will have to be reprogrammed.

## BEFORE THE ASSEMBLY

1. Before starting work, switch off the ignition and remove the ignition key. If necessary, remove the main power switch.
2. Disconnect the negative terminal of the battery. Do not allow the battery to be reconnected by mistake.
3. When mounting the device in the vicinity of a magnetic compass, maintain a protective distance from the compass.
4. If required for the system, purchase an NMEA 2000 drop cable with five-pin M12 connector (max drop cable length 6 m) and a video cable with a compatible four-pin M12 connector (A2C1845710001). These are not included.

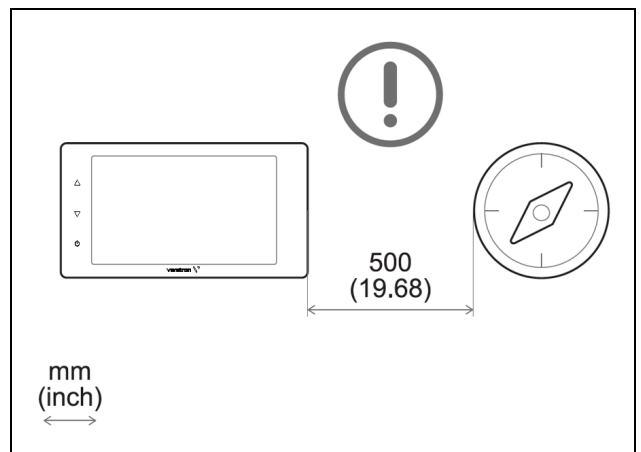
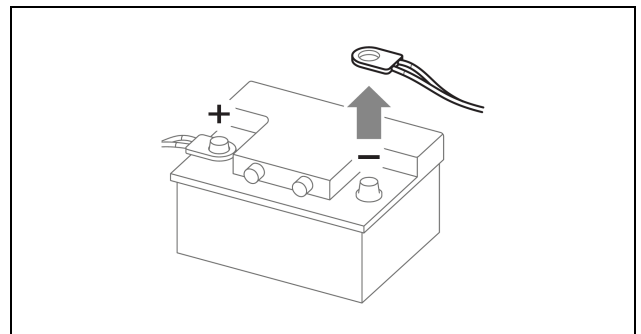
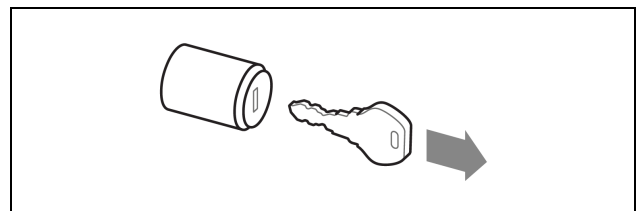



PANEL MOUNTING

**⚠ WARNING**

- Do not drill holes or installation openings in supporting or stabilizing beams!
- The mounting location must have sufficient clearance behind the mounting holes or openings.

1. Make a rectangular hole in the panel using the drilling template (see next page of this document) and considering the device dimensions [A].
2. Turn in the four grub screws of the installation kit on the backside of the device
3. Thread the cables through the hole and connect the connectors.

**NOTE:** screw in M12 connectors with care. If they screw with difficulty, remove and screw them back in.

4. Insert the device from the front and tighten the four nuts on top of the plastic clamps to pull the display towards the panel [B].
5. Remove the protection film from the display and make sure it is clean and dry.
6. Install the sun cover in front of the display by placing it onto it and pressing it on the lateral sides with your fingers to clamp it.

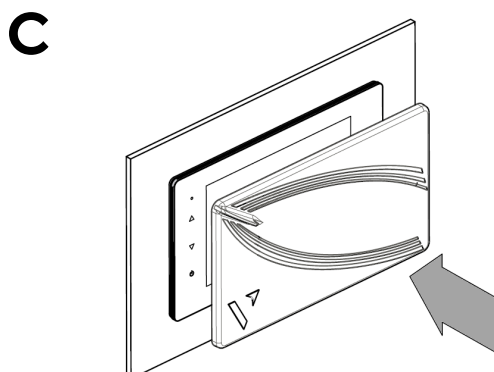
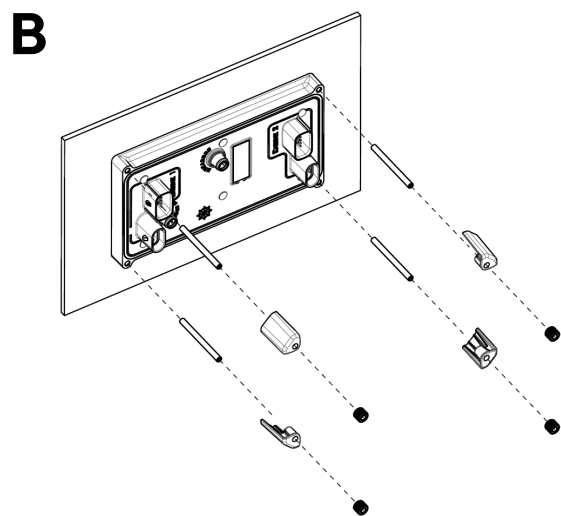
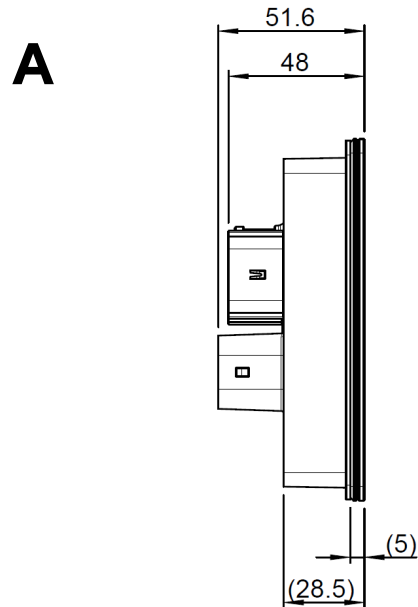

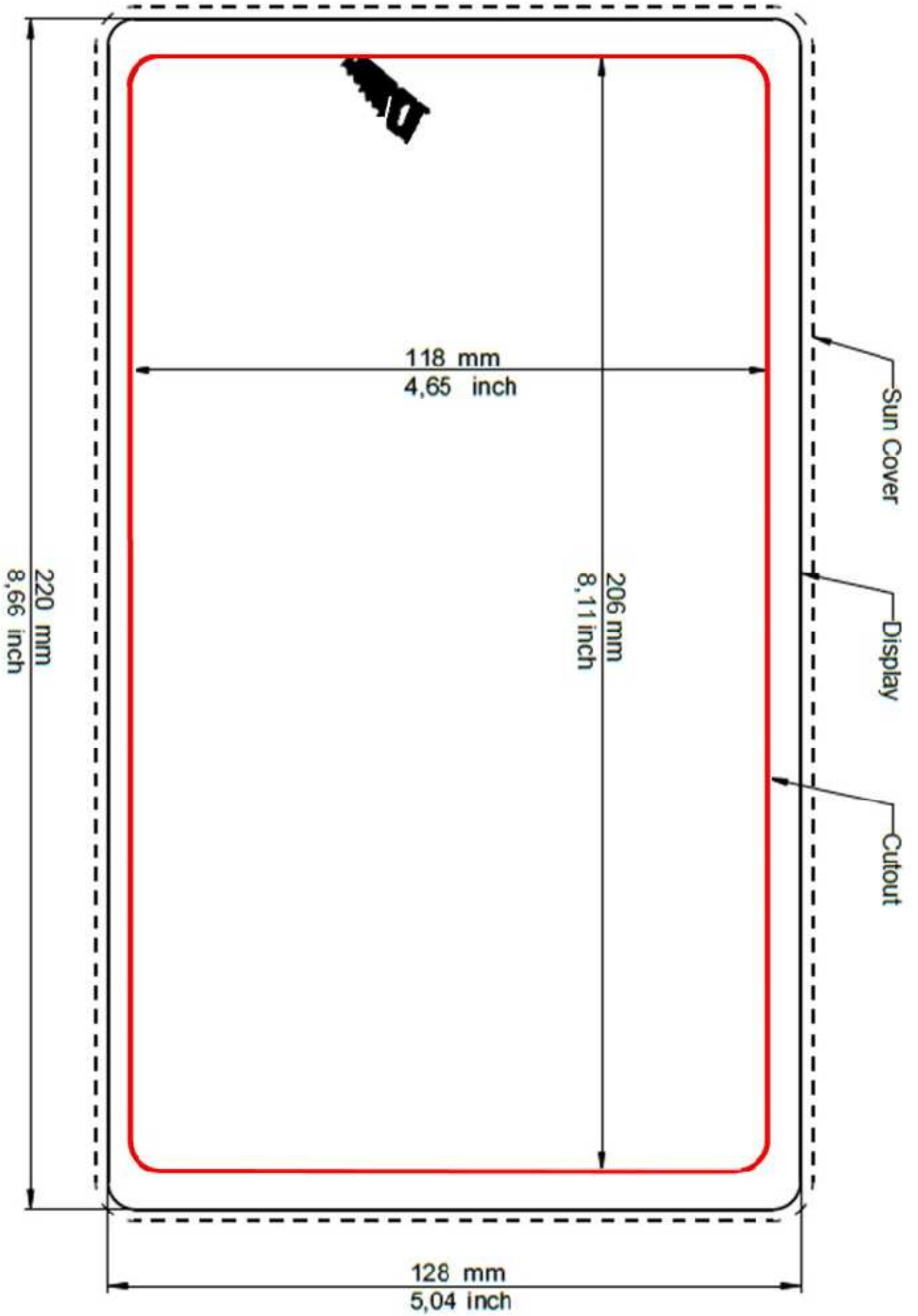

# ELECTRICAL CONNECTIONS

## ⚠ WARNING

- Refer to the safety rules described in the electrical connections section of the safety information chapter of this document!

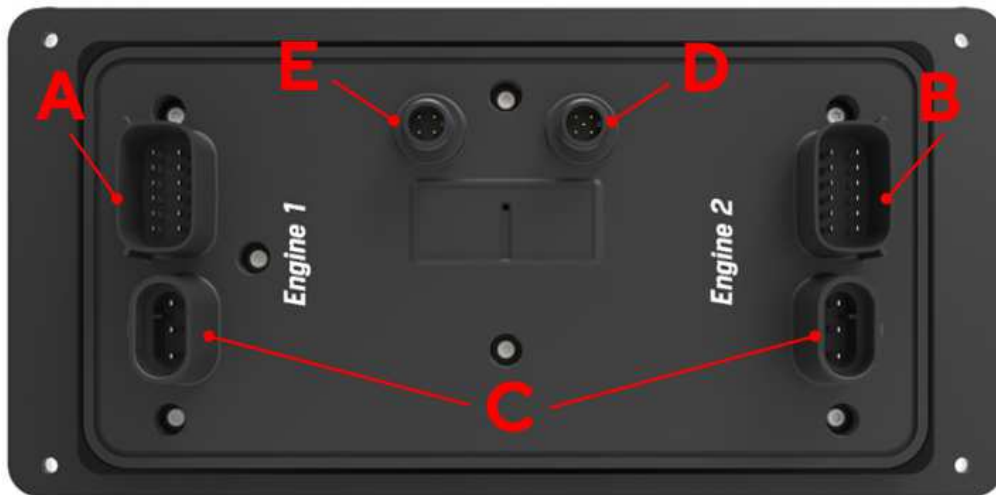

### ENGINE 1 CONNECTOR [A]

| Pin No. | Wire color   | Description                      |
|---------|--------------|----------------------------------|
| 1       | Red          | KL. 30 - Battery power 12 / 24 V |
| 2       | Black        | KL. 31 - Ground                  |
| 3       | White        | Alarm output                     |
| 4       | Green        | Frequency sensor signal - RPM    |
| 5       | Blue         | SAE J1939 - CAN Low              |
| 6       | Blue / White | SAE J1939 - CAN High             |
| 7       | Yellow       | KL. 15 - Ignition positive       |
| 8       | Grey         | Resistive sensor input           |
| 9       | Brown        | Resistive sensor input           |
| 10      | Orange       | 0-5 V sensor input               |
| 11      | Light Blue   | 4-20 mA sensor input             |
| 12      | Violet       | 4-20 mA sensor input             |

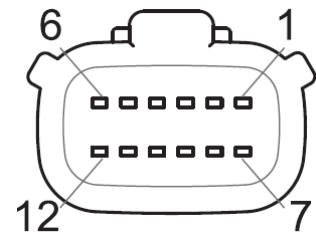

Molex MX150 12-poles connector, cable view and wire harness A2C1507870001 (included)

**ENGINE 2 CONNECTOR [B]**

| Pin No. | Wire color   | Description                   |
|---------|--------------|-------------------------------|
| 1       | Pink         | Configurable alarm input      |
| 2       | Black        | KL. 31 - Ground               |
| 3       | White        | Alarm output                  |
| 4       | Green        | Frequency sensor signal - RPM |
| 5       | Blue         | SAE J1939 - CAN Low           |
| 6       | Blue / White | SAE J1939 - CAN High          |
| 7       | Yellow       | 0-5 V sensor input            |
| 8       | Grey         | Resistive sensor input        |
| 9       | Brown        | Resistive sensor input        |
| 10      | Orange       | 0-5 V sensor input            |
| 11      | Light Blue   | Resistive sensor input        |
| 12      | Violet       | Resistive sensor input        |

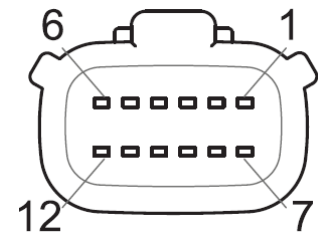

Molex MX150 12-poles connector, cable view and wire harness A2C1507870001 (included)

**EASYLINK CONNECTORS [C]**

| Pin No. | Description   |
|---------|---------------|
| 1       | +12V Power    |
| 2       | GND           |
| 3       | EasyLink Data |

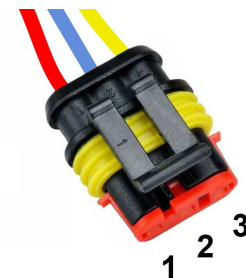

AMP SuperSeal 1.5 3 poles plug female, cable view

The EasyLink interface is meant for connecting VMH 14 satellites.

It is possible to connect up to 16 gauges per channel (daisy-chain) as shown in the picture on the right.

Each channel can display the data from one engine. The engine displayed can be configured in [SYSTEM CONFIGURATIONS] > [EASYLINK].

OceanLink satellites are not supported.

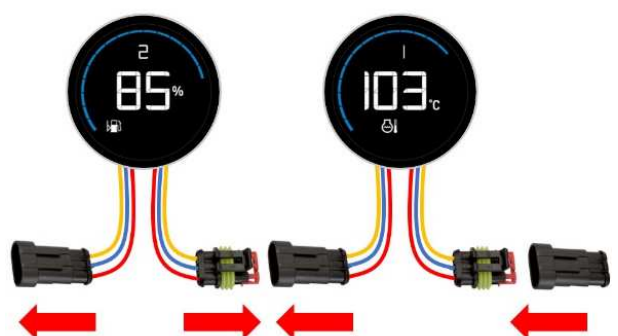

**ELECTRICAL CONNECTIONS**

**NMEA 2000® CONNECTOR [D]**

| Pin No. | Description      |
|---------|------------------|
| 1       | Shield           |
| 2       | NET-S (V+)       |
| 3       | NET-C (V-)       |
| 4       | NET-H (CAN High) |
| 5       | NET-L (CAN Low)  |

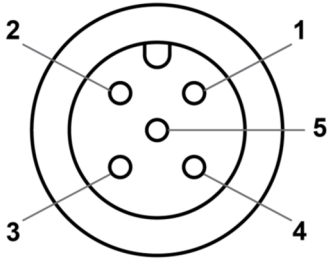

Micro-C M12 5 poles plug male, cable view

Once the installation is complete, you can interface the device to the NMEA 2000® network through the dedicated connector [D].

Be sure to tighten the M12 connector by screwing it onto its counterpart in order to preserve its watertightness.

An accessory drop cable is required. (Not included)

Note that NMEA 2000® does not allow drop cables longer than 6 meters.

Refer to the NMEA 2000® standard for proper network design.



**VIDEO INPUT CONNECTOR [E]**

| Pin No. | Description   |
|---------|---------------|
| 1       | Video input 2 |
| 2       | Video input 1 |
| 3       | GND 2         |
| 4       | GND 1         |

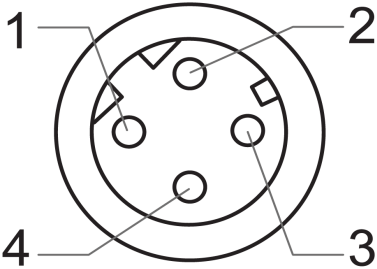

M12 4 poles plug female, cable view

ELECTRICAL SCHEMATIC

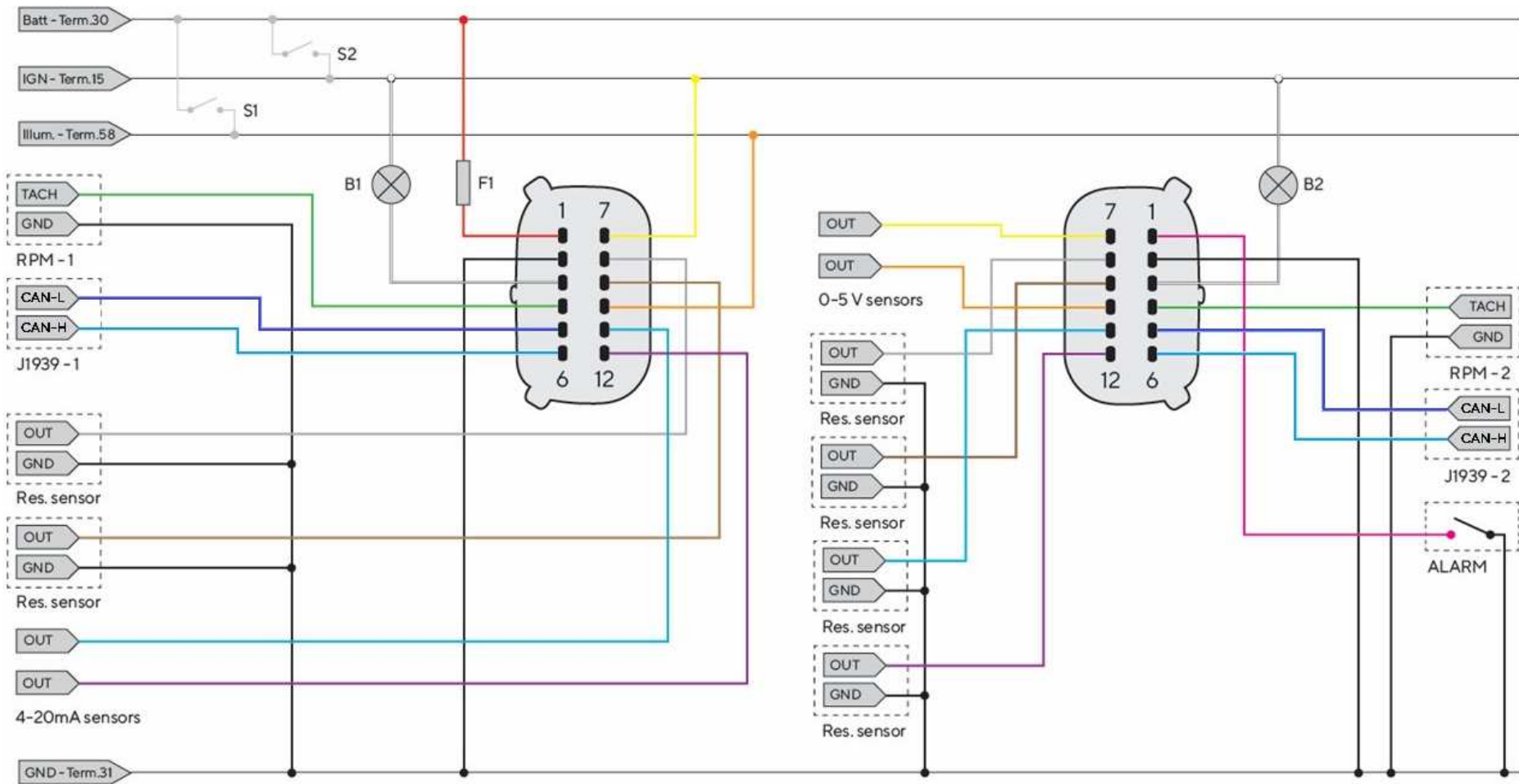

Designations in the circuit diagram

**Batt** - Term.30 - Battery Power 12/24 V  
**IGN** - Term. 15 - Ignition positive  
**GND** - Term. 31 - Ground  
**Illum.** - Term.58 - Illumination positive

**S1** - Day/Night mode switch (not included)  
**S2** - Ignition key  
**F1** - 3A fuse (not included)  
**B1/B2** - External acoustic alarm (not included)

**RES** - Resistive inputs  
**RPM** - Frequency inputs  
**ALARM** - External digital alarm  
**J1939** - SAE J1939 CAN ports

RPM SENSOR CONNECTION

The engine RPM signal can be obtained from different sources, respectively the alternator “W” terminal, the ignition coil terminal “1”, or from dedicated sensors such as a generator or an inductive sensor.

It is advisable to use sensors with isolated ground, and it is necessary to ensure that the sensor ground is connected to the display ground to avoid incorrect readings.

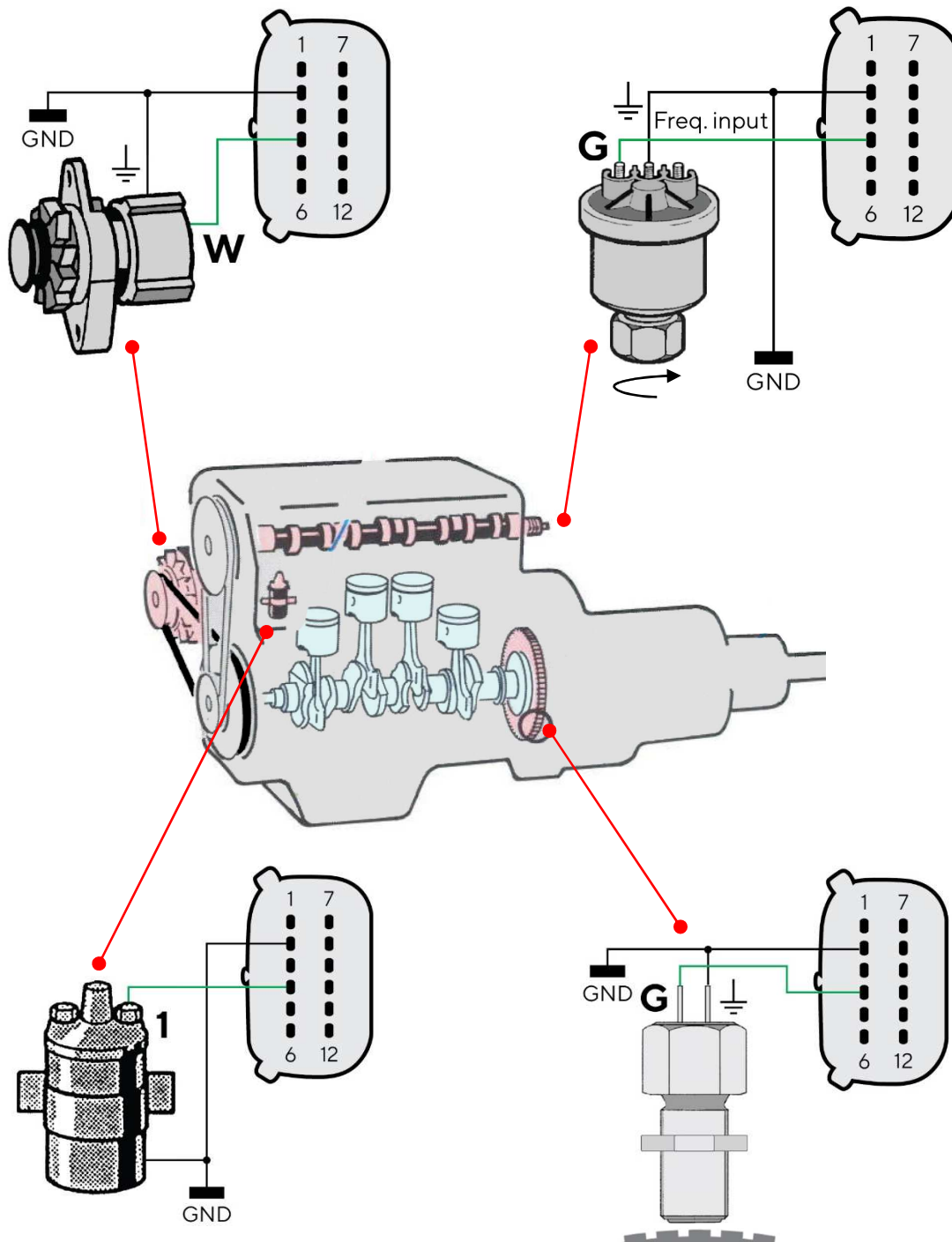

### RESISTIVE SENSOR CONNECTION

Any sensor connected to a resistive input of the display must be connected as shown in the figure. It is advisable to use sensors with isolated ground, and it is necessary to ensure that the sensor ground is connected to the display ground to avoid incorrect readings.

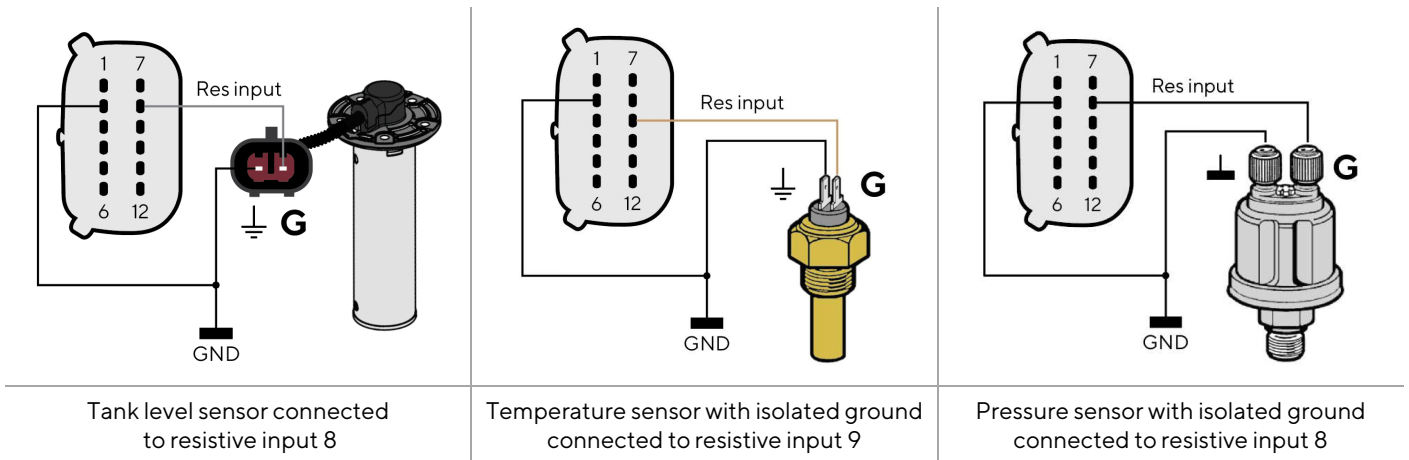

### EXTERNAL BUZZER CONNECTION (B1)

The display supports the connection of two external alarms (B1/B2) via the dedicated alarm outputs.

This buzzer/lamp can be powered at different voltages (consult the buzzer manufacturer's manual), as the alarm output is connected to ground inside the display. (Open collector output)

It is important to note that the maximum current supported is 500mA.

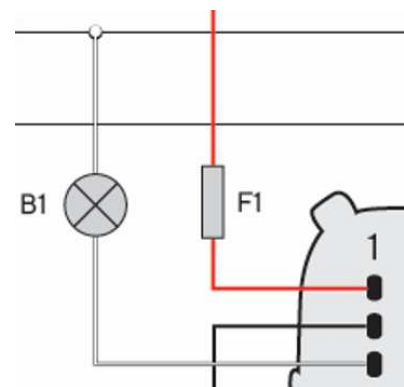

### DAY / NIGHT MODE SELECTOR SWITCH (S1)

The display allows you to set two display illumination levels, one for day and night.

It is possible to switch between day and night mode by means of a switch external to the display (S1) connected to the power supply (KL.30), or by connecting to the lights signal onboard KL.58, if present.

Every 0-5V input of the display can be configured for this purpose (see "Sensors' configuration").

To set the desired mode, act on the selected illumination input pin on the MX150 connector as follows:

| To set the mode... | Then...                                      |
|--------------------|--|
| day                | move the pin switch to <b>GND/OPEN</b> .     |
| night              | move the pin switch to <b>BATTERY PLUS</b> . |

In the sensor settings the function of the according voltage input must be defined as illumination input.



**PRIORITY OF RECIEVED SIGNALS**

If the same data is available from more than one source for the same engine, the received signal priority is the following:

- Analog input
- SAE J1939
- NMEA 2000

# GETTING STARTED

## OPERATIONAL CONCEPT

During normal operation the display shows one out of the up to ten customizable data pages. Swipe the touchscreen to the left or right to scroll through these pages.

To access the VMH 70 menu, press the field MENU in the screens lower left corner. This button leads to the main menu from where there are four sub-menus:



- **System Configuration**  
Change the system parameters like brightness, units or time.
- **Screen Configuration**  
Delete pages, add new ones or personalize the data to be displayed on the current ones.
- **Alarms**  
See the active alarms and define the settings for when an alarm should be displayed, sent out or trigger the external buzzer.
- **Sensor Configuration**  
Define all the settings for the analog inputs.

For more information on these menus refer to the respective chapters of this document.

The display brightness can be changed at any time by pushing the arrow buttons on the left side of the device.

## STANDBY MODE

The VMH 70 display supports a standby mode, where the display is simply shut off to either reduce the current consumption or just to turn off the illuminated display in dark conditions when not needed.

Please note that during standby mode the unit is totally operative, and it can be instantly turned back on.

To activate the standby mode, just press the touch button with the power symbol.



## SWITCHING ON AND OFF

The on/off mode depends on the ignition signal on terminal 15 (connected to Engine1 connector, pin 7 - yellow wire).



At power up, logo and software version followed by a security message appear followed by the last data page viewed before turned off.

While the VMH 70 is turned on, it can be put into standby mode as described above.

You can customize the loading image displayed at power up using the Veratron Configuration Tool. Contact your Veratron dealer for more information.



## MENU BUTTON FUNCTIONS

When operating the menu these buttons will be displayed on the right edge of the display. Use them to navigate through the menu. It is not possible to scroll the menu by swiping the list.

| Button  | Name       | Function   |
|---|------------|--|
|  | BACK       | <ul style="list-style-type: none"> <li>Return to the previous menu</li> </ul>                    |
|  | UP<br>DOWN | <ul style="list-style-type: none"> <li>Scroll options</li> </ul>                                 |
|  | ENTER      | <ul style="list-style-type: none"> <li>Open a sub-menu</li> <li>Confirm the selection</li> </ul> |

## TOUCH BUTTON FUNCTIONS

The following touch buttons are incorporated into the glass on the left of the screen. While the data screens are displayed the buttons serve the following functions:

| Button  | Name       | Function  |
|---|------------|---|
|   | UP<br>DOWN | <ul style="list-style-type: none"> <li>Change illumination brightness</li> </ul>  |
|  | STANDBY    | <ul style="list-style-type: none"> <li>Push this button to bring the display in the standby mode or to start it up after being in standby.<br/>(Only works if the ignition signal is turned on as well.)</li> </ul> |

## CALIBRATION WIZARD

The Calibration wizard appears when first turned on after reset and every time turned on until sensors are calibrated.

The display prompts you to configure your sensors.

Choose [Yes], to open menu SENSOR CONFIG.

Choose [No], to display the first default data page and configure the sensors later.

## SET THE DAY/NIGHT MODE

There are three ways to steer the display to be in day- or night mode:

- **Illumination input**  
Define one of the 0-5Volt analog inputs to be an illumination input and connect it to an external switch or to the vessel's illumination signal. For more information on the installation see chapter "Day / Night Mode Selector Switch (S1)" in the section "Electrical Connections".
- **Light sensor**  
Enable the built-in light sensor in [SYSTEM CONFIGURATION]>[DISPLAY]>[Auto Day/Night Switch] so the display automatically toggles between day and night mode depending on the surroundings brightness.
- **Manually through menu**  
To manually switch between the different modes, make a selection in the menu [SYSTEM CONFIGURATION]>[DISPLAY]>[ILLUMINATION MODE].

## STARTUP CHECKLIST

Following are the steps for initial configuration:

1. Connect any sensors to analog inputs.
2. When turned on, read the security message, then select [Yes] to open the menu SENSOR CONFIGURATION and define the sensors parameters (see "Sensor configuration").
3. Set up general device operations (see "System settings").
4. Add/remove data pages selecting the best layout and data to be viewed (see "Data page configuration").
5. If a page layout with bar graphs is used, customize the minimum and maximum intervals (Bar graph settings, see "System settings").
6. Enable/disable local, NMEA 2000 and J1939 alarms (see "Alarm management").

## UPLOAD A CUSTOM SPLASH LOGO

A custom splash logo can be loaded from a PC using the Veratron Configuration Tool. That logo will be displayed each time during the startup process.

For more information, please refer to the Veratron Configuration Tool user manual or contact your Veratron reseller.

# DATA SCREENS

Data screens show the data received from the various sources. The display can store up to 10 data screens. By default, five screens are displayed [Dual Engine, NavDash, Quad Data, Battery Screen, Video]. The alarms page appears at the end of the data pages if there are any active alarms.

## SCREENS SCROLLING

To scroll pages, swipe the touch screen horizontally with your finger. See "Data page configuration" to find out more about adding, deleting or editing pages.

## SCREEN LAYOUTS

Every screen contains some common elements, which are always displayed independently of the screen layout which is chosen.

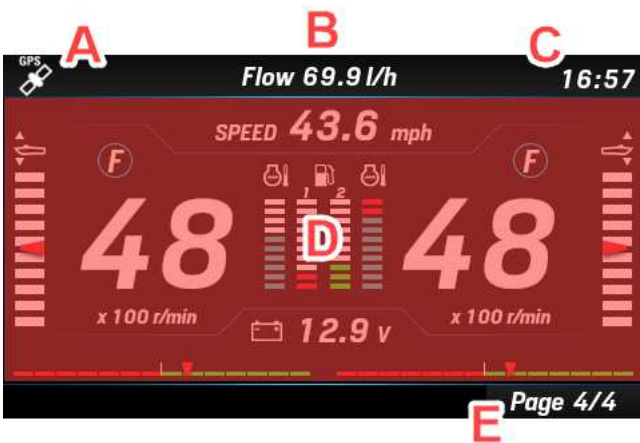

| Part | Description                                   |
|------|---|
| A    | GPS signal availability (GPS not included)    |
| B    | Screen title or additional data field (fixed) |
| C    | GPS time (if received)                        |
| D    | Screen content                                |
| E    | Page number                                   |

The screen content [D] depends on the screen configuration that the user has selected for a specific screen (see "Screen Configuration").

Each screen can be customized with one of the following available layouts:

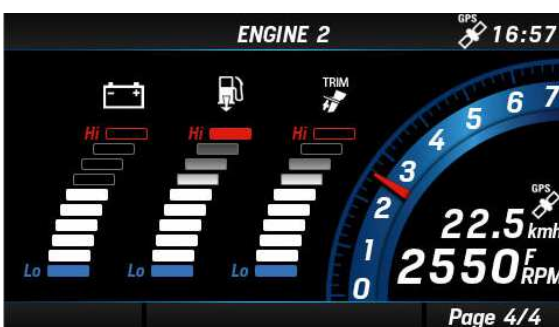

### SINGLE ENGINE LAYOUT

gauge for engine revolutions and speed to ground with three bar graphs for data selected from Boost pressure, Trim, Engine coolant temperature, Battery voltage, Fuel consumption.

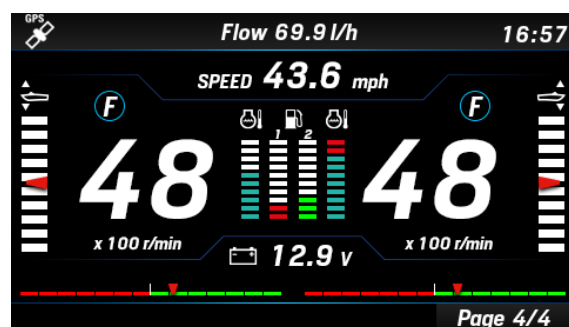

### DUAL ENGINE LAYOUT

with three bar graphs for the three defined data: trim, engine coolant temperature, fuel level. Also the rudder angle, the engine speed, the battery voltage, the speed and the gear are displayed.

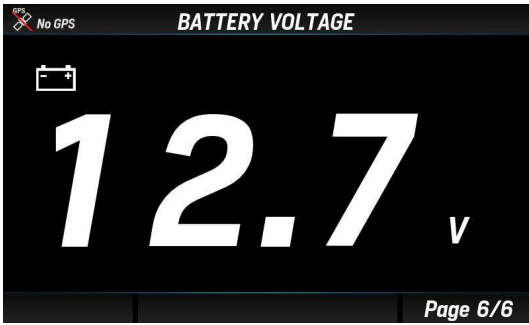

**SINGLE DATA LAYOUT**

Single data display. The data value is numeric or displayed by a gauge.



**TRIPLE DATA LAYOUT**

Three boxes, from three data to nine data.

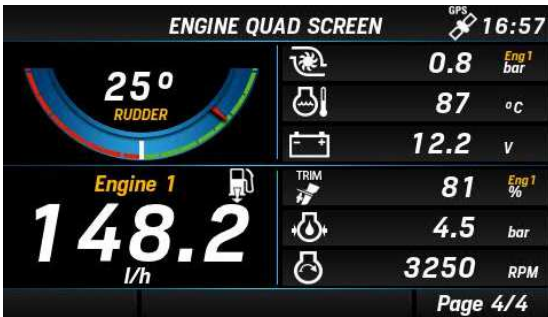

**QUAD DATA LAYOUT**

Four boxes, from four data to twelve data.

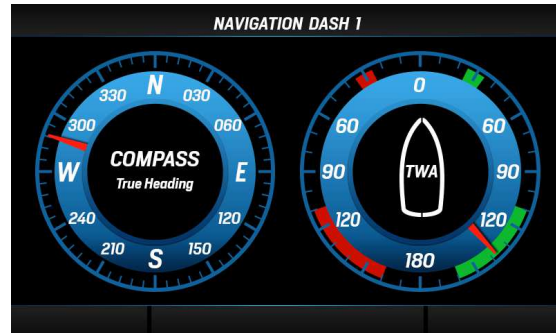

**NAV DASH SCREENS**

This layout allows to display data in an analog fashion. Three NavDash layouts are available with two, three, or eight gauges into the screen.

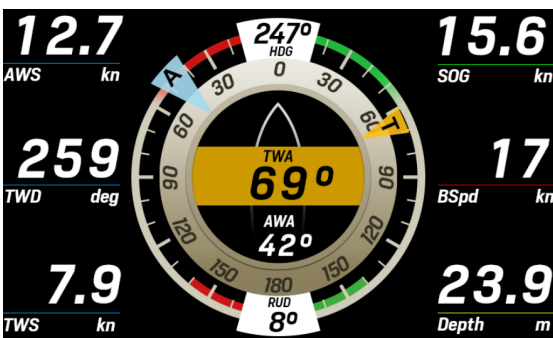

**WIND SCREEN**

Dedicated screen layout for navigation with graphical representation of both apparent and true wind data. Six customizable data fields are designed aside.

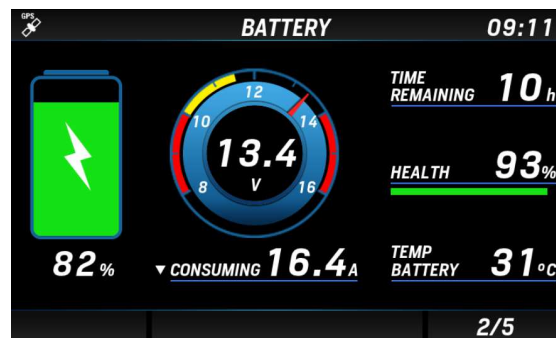

**INTELLIGENT BATTERY MONITOR SCREEN**

Dedicated screen for battery monitoring including extensive battery information coming from the Intelligent Battery Sensor (IBS).

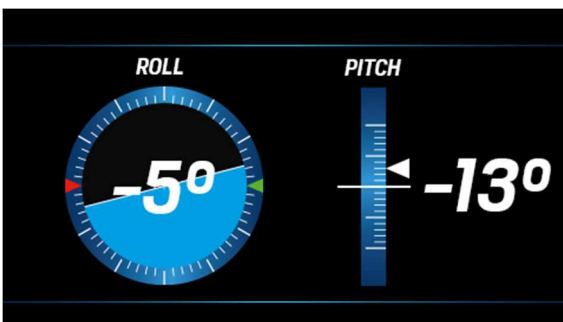

**PITCH AND ROLL SCREEN**



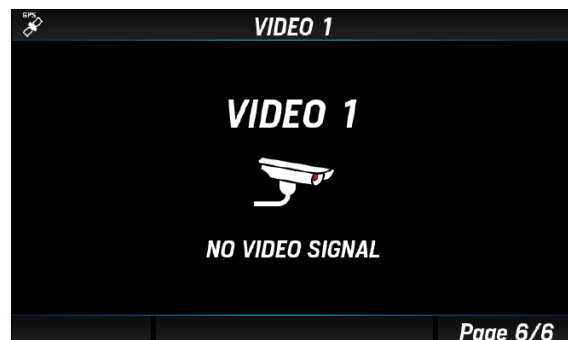



















Monitors your boat inclination, with the information retrieved from a connected NavSensor, for example.









**VIDEO SCREEN**

Displays the video received from the external video camera.

## SUPPORTED DATA

| Icon  | Data                          | Input     |           |                         | Output    | Unit            |
|---|-------------------------------|-----------|-----------|-------------------------|-----------|-----------------|
|   |                               | NMEA 2000 | SAE J1939 | Analogue                | NMEA 2000 |                 |
|    | Engine rpm                    | x         | x         | x                       | x         | rpm             |
|    | Engine trim                   | x         | -         | x                       | x         | %               |
|    | Engine boost pressure         | x         | x         | x                       | x         | bar , psi , kPa |
|    | Engine coolant temp           | x         | x         | x                       | x         | °C , °F         |
|    | Battery voltage               | x         | -         | x                       | -         | V               |
|    | Fuel rate                     | x         | -         | -                       | -         | gal/h , L/h     |
|    | Fuel pressure (PGN 127489)    | x         | x         | -                       | -         | bar, psi        |
|    | Air Intake Temperature        | -         | x         | -                       | -         | °C , °F         |
| <b>LOAD</b>   | Engine load                   | x         | x         | -                       | -         | %               |
|    | Exhaust temperature           | x         | x         | -                       | -         | °C , °F         |
|   | Engine oil temperature        | x         | x         | x                       | x         | °C , °F         |
|  | Engine oil pressure           | x         | x         | x                       | x         | bar , psi , kPa |
|  | Transmission oil temperature  | x         | x         | x<br>(PC Tool required) | x         | °C , °F         |
|  | Transmission oil pressure     | x         | x         | x                       | x         | bar , psi , kPa |
|  | Engine hours                  | x         | x         | x                       | x         | h               |
|  | Rudder angle                  | x         | -         | x                       | x         | °               |
|  | Depth                         | x         | -         | -                       | -         | m , ft          |
|  | Fuel level (Tank: 1-4)        | x         | x         | x                       | x         | %               |
|  | Fresh water level (Tank: 1-4) | x         | -         | x                       | x         | %               |
|  | Waste water level (Tank: 1-4) | x         | -         | x                       | x         | %               |
|  | Sea water temperature         | x         | -         | -                       | -         | °C , °F         |
| -   | Air temperature               | x         | -         | -                       | -         | °C , °F         |
| <b>BARO</b>   | Atmospheric pressure          | x         | -         | -                       | -         | hPa             |
|  | Course over ground (COG)      | x         | -         | -                       | -         | °               |
|  | True heading                  | x         | -         | -                       | x         | °               |
| <b>AWA</b>  | Apparent wind angle (AWA)     | x         | -         | -                       | x         | °               |
|  | Apparent wind speed (AWS)     | x         | -         | -                       | x         | km/h            |
| <b>TWA</b>  | True wind angle (TWA)         | x         | -         | -                       | -         | km/h            |

## DATA SCREENS

| Icon  | Data                      | Input     |           |          | Output    | Unit          |
|---|---------------------------|-----------|-----------|----------|-----------|---------------|
|   |                           | NMEA 2000 | SAE J1939 | Analogue | NMEA 2000 |               |
|  | True wind speed (TWS)     | x         | -         | -        | x         | km/h          |
|  | True wind direction (TWD) | x         | -         | -        | x         | °             |
|  | Speed through water (STW) | x         | -         | -        | -         | mph, kn, km/h |
|  | Trip distance             | -         | -         | -        | -         | km, mi, nm    |
|  | Trip time                 | -         | -         | -        | -         | h             |
|  | Trip fuel                 | -         | x         | -        | -         | L, gal        |
|  | GPS speed                 | x         | -         | -        | -         | mph, kn, km/h |
| -   | Roll                      | x         | -         | -        | -         | °             |
| -   | Pitch                     | x         | -         | -        | -         | °             |
| -   | Position                  | x         | -         | -        | -         | °             |
| <b>SOC</b>  | Battery Charge            | x         | -         | -        | -         | %             |
| -   | Battery Current           | x         | -         | -        | -         | A             |
| -   | Battery Autonomy          | x         | -         | -        | -         | h, d          |
| <b>SOH</b>  | Battery Health            | x         | -         | -        | -         | %             |
| -   | Battery Temperature       | x         | -         | -        | -         | °C, °F        |

## ENGINE HOURS

In the absence of data received from the NMEA 2000 network, the indicator considers the internally counted value. The time is counted as engine hours when the engine speed is more than 300 RPM. In the presence of data from the NMEA 2000 network, the indicator considers the data received from the network only if higher than the internal data.

## DISTANCE TRAVELED

The indicator internally calculates the distance travelled based on the speed while taking in account the correction factor set in [SENSOR CONFIGURATIONS] > [SPEED].



## NAVDASH LAYOUT

The NavDash layout is available in three different configurations with respectively two, three, and eight round gauges displayed.

Every layout is displayed in blue or amber color palette, and in day or night mode depending on the current display setup.

The slots of these configurations can be customized with different gauges, selectable among the following:

- Engine revolutions
- Depth
- Rudder angle
- Apparent wind angle (AWA)
- Apparent wind speed (AWS)
- True heading
- Speed through water (STW)
- Speed over ground (SOG)
- Fuel level
- Fresh water level
- Waste water level
- Trim
- Battery voltage
- Engine- and transmission oil pressure
- Engine- and transmission oil temperature
- Coolant temperature

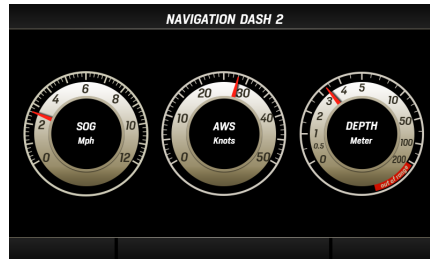
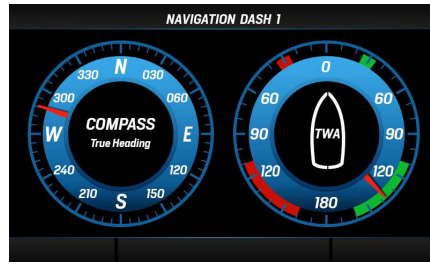

# SCREENS CONFIGURATION

To access the screens configuration settings, enter the HOME screen by pressing the MENU button and select [SCREENS CONFIGURATION] to enter the settings.



1. Access the HOME screen by pressing [MENU] and select [SCREENS CONFIGURATION] to enter the screens' configuration.

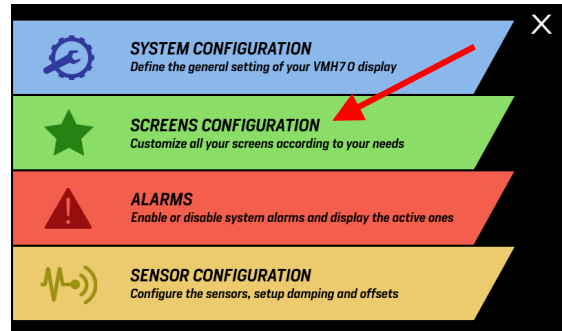

2. Scroll the favorite screens until the one to be customized (or deleted) is displayed and press [ENTER] to confirm.

To add a new screen at the end of the favorites, just scroll until an empty screen slot is selected.

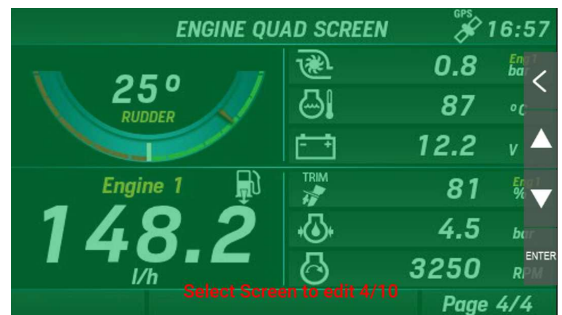

3. Choose the screen layout for the new screen among the ones described in "Screens layouts".

To delete the selected screen, select [REMOVE PAGE.]

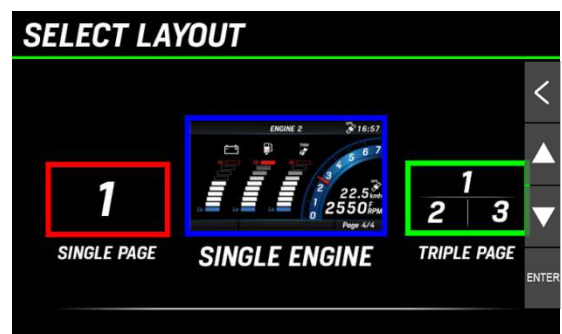

4. Depending on the chosen layout it is possible to customize some parts of the screen like data fields or bar graphs.

The currently selected item is highlighted in green color.

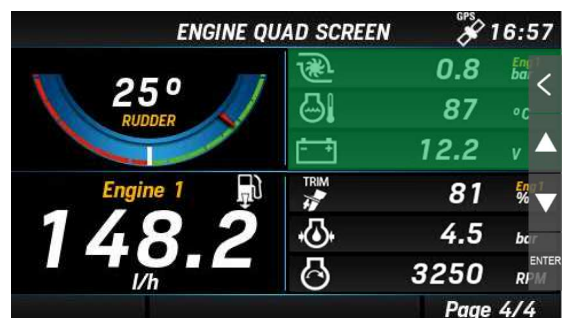

Press ▲ or ▼ to select the next field

## SCREENS CONFIGURATION

Scroll through the customizable items by pressing the UP and DOWN buttons.

Press [ENTER] to select the item to be customized.

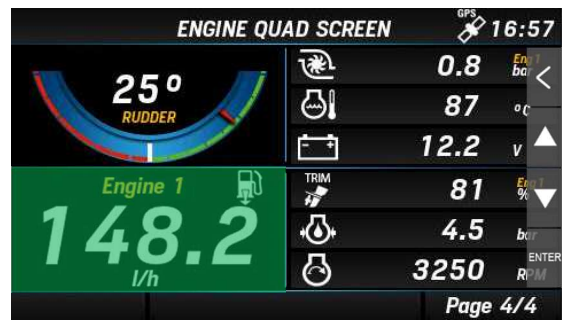

5. Once an item is selected it will be highlighted in red color.

Press the UP/DOWN buttons to modify the data displayed on that item.

See the chapter "Supported Data" for the complete list of available data.

Once the displayed data is found, press [ENTER] to confirm the selection and the item is highlighted in green color again.

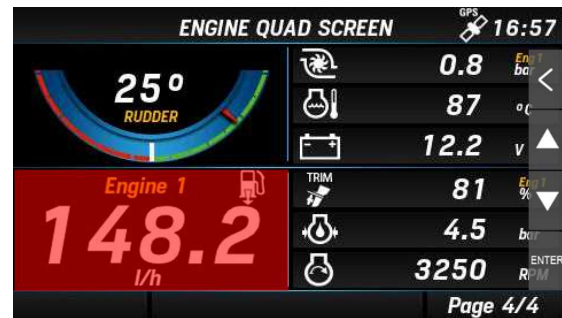

Press ▲ or ▼ to change the data

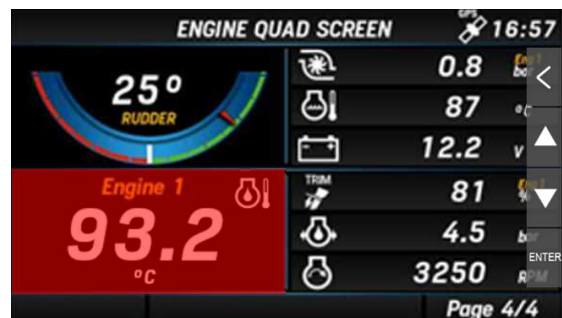

6. To customize another screen, press [BACK] several times until you're back to the screen selection described at point 2.

To quit the settings and return to normal operation, also press [BACK] several times.

# SYSTEM CONFIGURATION

To access the system settings, enter the HOME screen by pushing [MENU] and selecting [SYSTEM CONFIGURATION] to enter the screens' configuration.



## MENU STRUCTURE

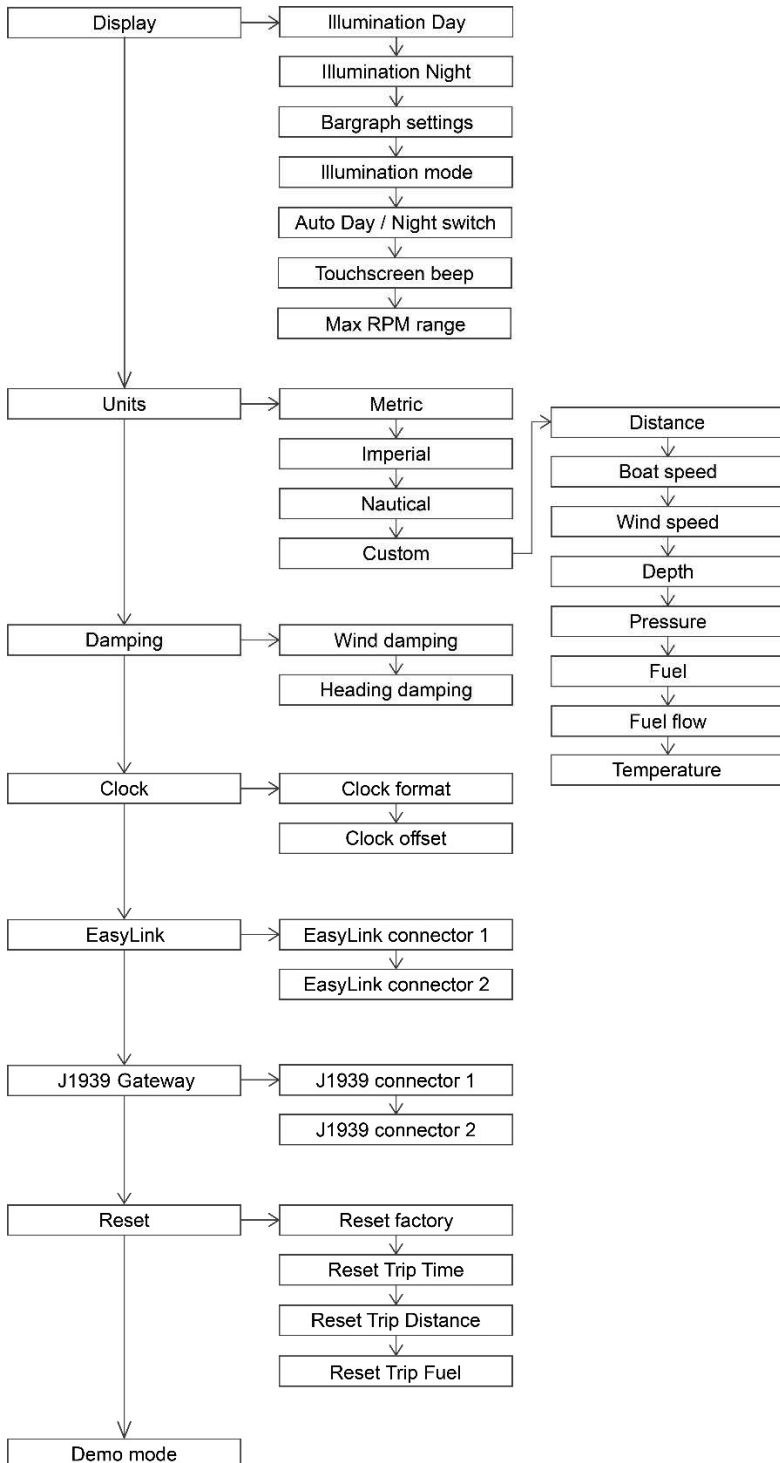

OPERATING THE SYSTEM CONFIG MENU

NOTE: the underlined value/command is the factory default one.

| Setting                         | Description   | Possible values / commands   |
|---------------------------------|---|--|
| Display > Illumination Day      | Brightness of the display for the day mode.<br><i>NOTE: this setup affects all the EasyLink gauges too.</i>   | 0-7, <u>Auto</u>   |
| Display > Illumination Night    | Brightness of the display for the night mode.<br><i>NOTE: this setup affects all the EasyLink gauges too.</i>   | <u>0-7</u>   |
| Display > Bargraph settings     | Bar graphs minimum and maximum setup.   | <ul style="list-style-type: none"> <li>• Boost press: 0-13 bar (default = 0-1)</li> <li>• Oil Press: 0-13 bar (default = 0-1)</li> <li>• Engine temp 0-300 °C (default = 0-200)</li> <li>• Battery voltage 8-32 V (default = 10-16)</li> <li>• Fuel flow 0-800 L/h (default = 0-150)</li> </ul>  |
| Display > Illumination mode     | Color palette and brightness profile selection.   | <ul style="list-style-type: none"> <li>• <b>Blue day:</b> blue dials, white numbers, Illumination: <u>Z</u></li> <li>• <b>Blue night:</b> blue dials, red numbers, Illumination: <u>2</u></li> <li>• <b>Amber day:</b> amber dials, white numbers, Illumination: <u>Z</u></li> <li>• <b>Amber night:</b> amber dials, red numbers, Illumination: <u>2</u></li> </ul> |
| Display > Auto Day/Night Switch | Enable the built-in light sensor to automatically change between day and night mode and sets at which level of brightness the display should toggle.<br><i>NOTE: This is only possible if the Illumination input (term. 58) is disabled in the sensor configurations.</i> | <ul style="list-style-type: none"> <li>• <u>OFF</u></li> <li>• Bright</li> <li>• Medium</li> <li>• Dark</li> </ul>   |
| Display > Touchscreen Beep      | Enable or disable the sound feedback for the touchscreen interactions.  | <ul style="list-style-type: none"> <li>• <u>ON</u></li> <li>• OFF</li> </ul>   |
| Display > Max RPM Range         | Select the measurement range for the engine speed. The dials in the different layouts will adapt to this maximum value.   | <ul style="list-style-type: none"> <li>• 3000, <u>4000</u>, 7000</li> </ul>  |
| Units                           | Unit of measure for the displayed data.   | <ul style="list-style-type: none"> <li>• <u>Metric</u></li> <li>• Imperial</li> <li>• Nautical</li> <li>• Custom</li> </ul>  |

**SYSTEM CONFIGURATION**

| Setting   | Description  | Possible values / commands  |
|---|--|---|
| Damping ><br>Wind damping/<br>Heading damping                   | Damping for wind and heading displayed data.   | <ul style="list-style-type: none"> <li>• No</li> <li>• <u>Low</u></li> <li>• Medium</li> <li>• High</li> </ul>  |
| Clock ><br>Clock format   | Clock format.  | <ul style="list-style-type: none"> <li>• <u>12h</u></li> <li>• 24 h</li> </ul>  |
| Clock ><br>Clock offset   | Time zone setup.   | From -12h to +12 h ( <u>0h</u> )  |
| EasyLink ><br>EasyLink connector<br>1 / EasyLink<br>connector 2 | <p>Which engine's data to be displayed on the VMH 14 EasyLink satellites.<br/>Setting always applies for the whole daisy chain on that connector</p> <p><i>NOTE: OceanLink satellites are not supported.</i></p> | <ul style="list-style-type: none"> <li>• Show engine data from:<br/>Engine 1-4</li> <li>• Show fuel level data from:<br/>Tank 1-4</li> </ul>  |
| J1939 ><br>Connector1 /<br>Connector 2                          | <p>Configuration for the SAE J1939 to NMEA 2000 gateway.</p> <p>All the data received from the J1939 bus will be sent on NMEA 2000 with the instance specified here.</p>   | <p>Send to NMEA 2000 As:</p> <ul style="list-style-type: none"> <li>• <u>Auto</u>: the display keeps the J1939 engine identifier also for the NMEA 2000 network.</li> <li>• Engine 1-4</li> </ul> |
| Reset ><br>Reset factory  | Reset the display to factory default.  | <ul style="list-style-type: none"> <li>• Yes</li> <li>• <u>No</u></li> </ul>  |
| Reset ><br>Reset Trip time                                      |  | <ul style="list-style-type: none"> <li>• Yes</li> <li>• <u>No</u></li> </ul>  |
| Reset ><br>Reset Trip Distance                                  |  | <ul style="list-style-type: none"> <li>• Yes</li> <li>• <u>No</u></li> </ul>  |
| Reset ><br>Reset Trip Fuel                                      |  | <ul style="list-style-type: none"> <li>• Yes</li> <li>• <u>No</u></li> </ul>  |
| Demo mode   | <p>Demo mode activation.<br/>Simulated data are NOT sent on NMEA 2000.</p> <p><i>Note: the demo mode will remain active after the unit is restarted.</i></p>   | <ul style="list-style-type: none"> <li>• On: display data are simulated. The simulation is sent on EasyLink satellites too.</li> <li>• <u>Off</u>: demo mode is off.</li> </ul>                   |

UNITS

| Setting     | Metric | Imperial | Nautical | Custom             |
|-------------|--------|----------|----------|--------------------|
| Distance    | km     | mi       | nm       | km, mi, nm         |
| Boat speed  | km/h   | mph      | kn       | km/h, mph, kn      |
| Wind speed  | km/h   | kn       | kn       | km/h, kn, m/s, bft |
| Depth       | m      | ft       | ft       | m, ft              |
| Pressure    | bar    | psi      | psi      | bar, psi, kPa      |
| Fuel        | L      | gal      | gal      | L, gal             |
| Fuel flow   | L/h    | gph      | gph      | L/h, gph           |
| Temperature | °C     | °F       | °F       | °C, °F             |

SAE J1939 GATEWAY

The VMH display is equipped with two independent SAE J1939 ports to connect your CAN engines to the display and read the digital data coming from them.

Make sure to properly setup the J1939 gateway so that all the engine data are transmitted on NMEA 2000 with the correct instance.

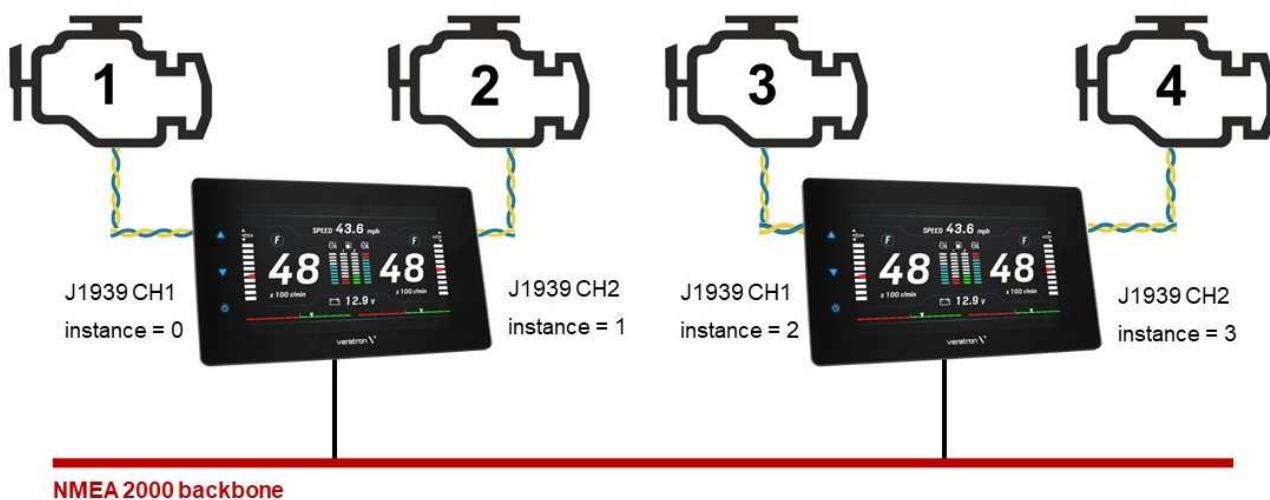

# SENSOR CONFIGURATION

To access the sensors' settings, enter the HOME screen by pressing the MENU button and select [SENSOR CONFIGURATION] to access it.



## MENU STRUCTURE

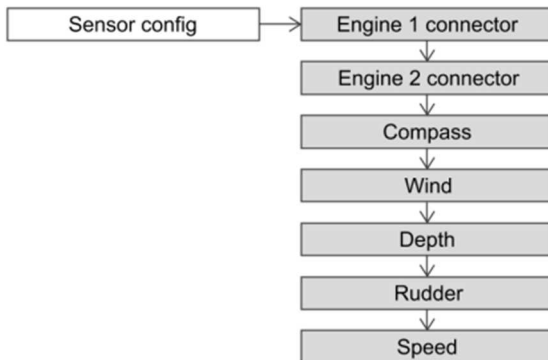

| Setting                         | Description  | Possible values                |
|---------------------------------|--|--------------------------------|
| Engine 1 connector              | Configure the sensors connected to the display through the analogue inputs of the Engine 1 connector (see "Electrical Connections"). | -                              |
| Engine 2 connector              | Configure the sensors connected to the display through the analogue inputs of the Engine 2 connector (see "Electrical Connections"). | -                              |
| Compass > Heading offset        | Angular offset between the compass and the bow of the boat.  | $\pm Q - 180^\circ$            |
| Compass > Variation             | Magnetic variation offset (polar difference between Magnetic North and True North)   | $\pm Q - 180^\circ$            |
| Compass > Send True Heading     | Activate to let the display transmit the calculated True Heading over NMEA 2000.   | Yes / <u>No</u>                |
| Wind > Wind direction offset    | Angular offset between the wind sensor 0° position and the longitudinal boat axis.   | $\pm Q - 180^\circ$            |
| Wind > Send True Wind           | Activate to let the display transmit the internally calculated True Wind data (TWA and TWS) over NMEA 2000.                          | Yes / <u>No</u>                |
| Depth                           | Depth offset setup. Positive for depth below waterline, negative for depth below keel.   | $\pm 0 - 9.9m$<br>(default 2m) |
| Rudder                          | Rudder offset setup.   | $\pm Q - 120^\circ$            |
| Speed > Speed correction factor | Correction for the boat speed data received via NMEA 2000. See "Calculate the speed offset".   | 0 - 199.99<br>(default: 1.00)  |



CONFIGURE A SENSOR CONNECTED TO THE DISPLAY

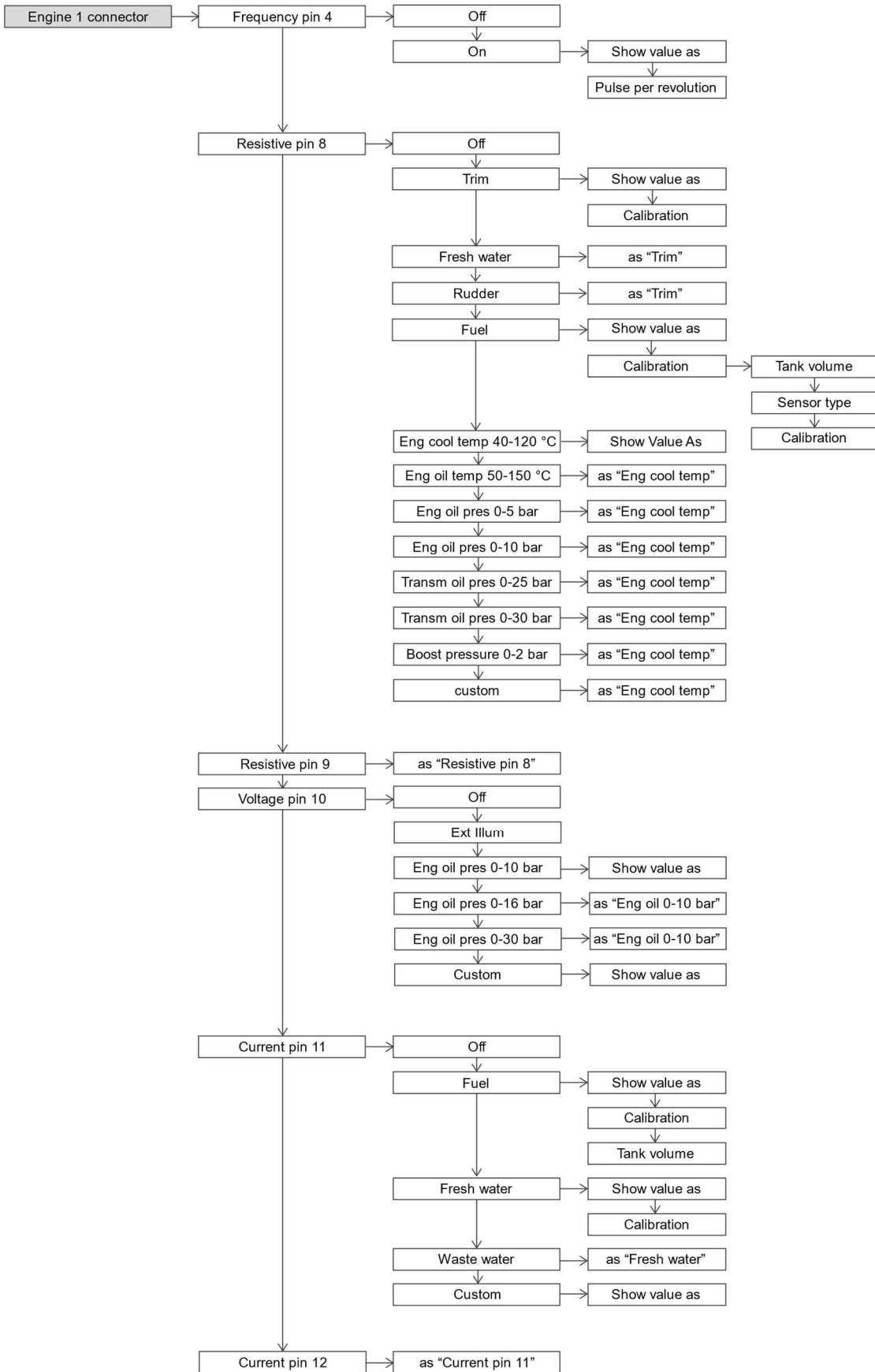

1. **INPUT SELECTION**

Once in the SENSOR CONFIG menu, select “Engine 1 connector” or “Engine 2 connector” depending on which connector the sensor is electrically connected to.

Then select the analogue input (on that connector) where the sensor output is wired.

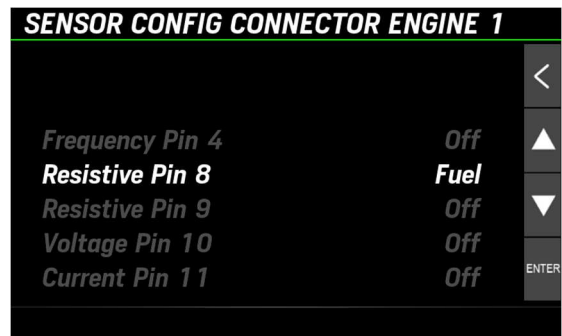

2. **CHOOSE THE SENSOR TYPE**

Select what kind of sensor is connected to that input.

See the menu diagram for the complete list of supported sensors.

Select “Custom” for importing the complete input configuration from the PC Veratron Configuration Tool.

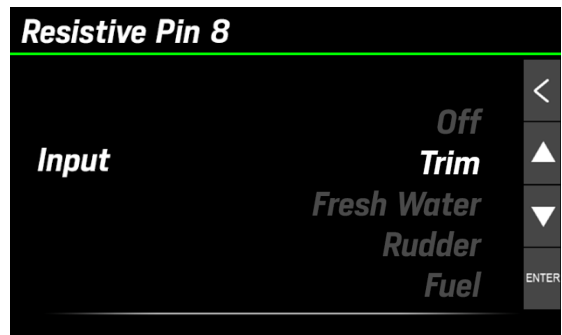

3. **CONFIGURE THE NMEA 2000 OUTPUT**

The measured value for the configured analog sensor is also transmitted over NMEA 2000, so the VMH display will act as a source for that data.

Use the menu item “Show Value As” to modify the NMEA 2000 instance for that sensor.

If a configuration conflict is detected in the setup (like when two sensors with same instance are configured on different analog ports), the display will show a warning.

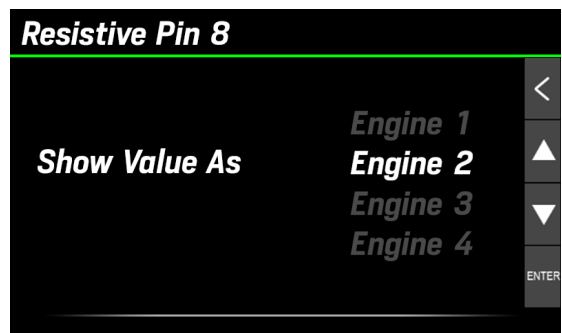

4. **CALIBRATE THE SENSOR**

Every sensor type has a standard calibration (see “Default supported calibrations”). Veratron sensors are by default supported.

It is however possible, for some sensors, to calibrate the sensor through a calibration wizard (see next chapters).

Every sensor type can be always calibrated via the PC-based Veratron Configuration Tool (see “Sensor calibration with Veratron Configuration Tool”).



**FUEL LEVEL SENSOR CALIBRATION**

1. In the input configuration menu described before, select "Calibration" to open the sensor's calibration options.
2. Select **Tank volume** to set the tank's capacity (not mandatory).
3. Select **Sensor type**, then select the sensor type among the proposed standard ones.
4. Select **Calibration**, then select the one or three-point calibration procedure (**Do 1 point cal/Do 3-point cal**). Calibration instructions and the ohmic value read in real-time from the sensor [A] appear.
5. Empty the tank and wait for the read value to stabilize. Then confirm by pressing [ENTER].
6. For three-point calibration, follow the on-screen instructions.
7. Return to the data pages by pressing [<]

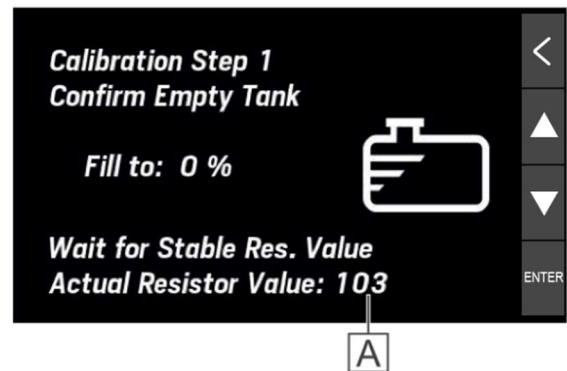
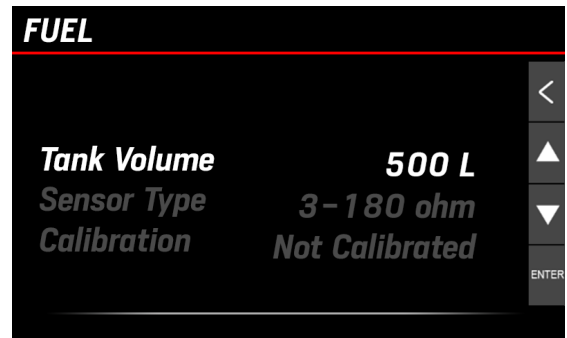

**OTHER SENSORS' CALIBRATION**

1. In the input configuration menu described before, select **Calibration** to open the sensor's calibration options.
2. Then select the three-point calibration procedure by accessing **Do 3-point cal**. Calibration instructions and the ohmic value read in real-time from the sensor appear.
3. For fresh and waste water sensors the tanks must be drained, then wait for the read value to stabilize. Confirm the reading by pressing [ENTER].
4. Proceed with all calibration points following the wizard.
5. Return to the data pages by pressing [<] several times.

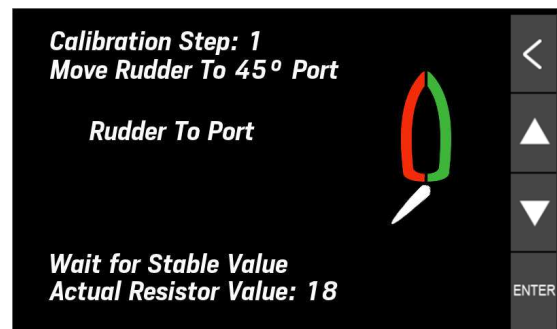
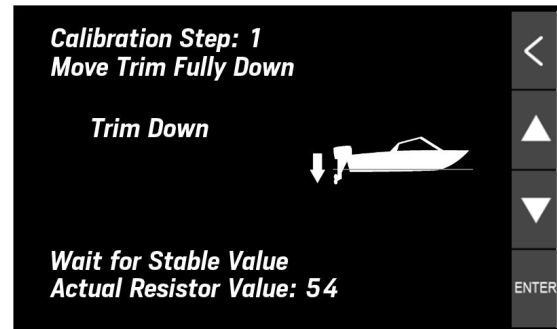

**CUSTOM SENSORS CONFIGURATION**

In the bottom part of the Sensor Configuration panel, it is possible to fully customize the configuration of every analog port of your VMH display.

*NOTE: this operation still requires you to perform some setting on the display itself (set the input to "Custom" and select the data instance).*

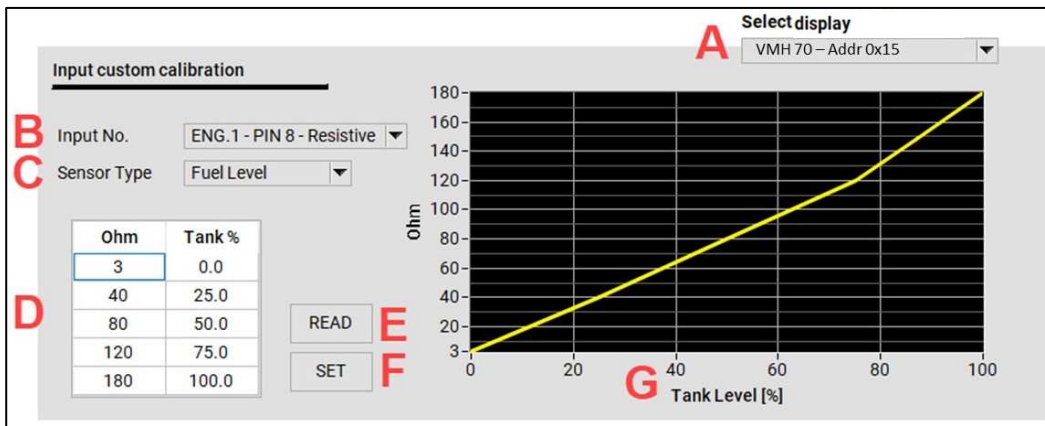

- 1 **Select the display** to be programmed from the drop-down list [A].  
If more VMH displays are on the network, they will all be visible in this list.

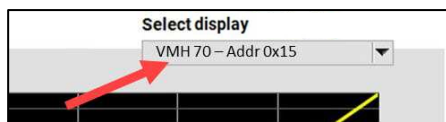

- 2 **IN THE DISPLAY MENU** set the pin configuration to **"CUSTOM"**.  
*Sensor Config → Choose the port to be configured → Input → Custom*

This setup is required on the display to allow the local pin configuration to be overwritten.

When CUSTOM is selected, the configuration must come from the Tool.

- 3 Back on the PC Tool, **select the input to configure [B]**.  
This selection must match the pin configured as CUSTOM on the display in the step before.

- 4 **Select the Sensor type** from the drop-down list [C].

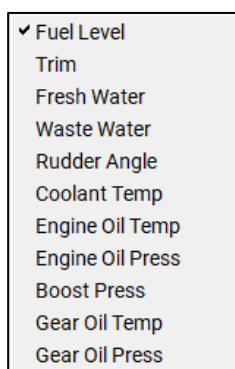

- 5 Manually set the 5-points calibration** into the table [D] for the selected sensor.  
The graph [G] will display the calibration being set.

| Ohm | Tank % |
|-----|--------|
| 3   | 0.0    |
| 45  | 25.0   |
| 90  | 50.0   |
| 135 | 75.0   |
| 180 | 100.0  |

*The example above is for a standard 3-180Ω fuel level sensor.*

- 6 Upload the configuration** to the display.  
Press the SET button [F] to write the configuration for the specific pin.  
A pop-up will appear as a safety confirmation.
- Press the READ button [E] to read back from the display the configuration for the pin defined in [A].

## DEFAULT CALIBRATIONS

| Sensor Type      | Calibration                |
|------------------|----------------------------|
| Fuel             | 240-33 Ω                   |
|                  | 3-180 Ω                    |
|                  | 2-90 Ω                     |
| Fresh Water      | 3-180 Ω (resistive inputs) |
|                  | 4-20mA (capacitive inputs) |
| Waste Water      | 3-180 Ω (resistive inputs) |
|                  | 4-20mA (capacitive inputs) |
| Trim             | 10-167 Ω                   |
| Rudder           | 10-180 Ω                   |
| Eng Coolant Temp | 291-22 Ω                   |
| Eng Oil Temp     | 197-11 Ω                   |
| Eng Oil Pressure | 10-184 Ω                   |
| Boost Press      | 10-184 Ω                   |

## ADJUSTING THE SPEED CORRECTION FACTOR

The speed correction factor lets you align the speed through water (STW) to the actual speed. If the measured speed differs from the real boat speed for more than 0.5 kn, this factor can be adjusted. Increasing the offset factor reduces the displayed speed through water (STW).

# ALARMS

The VMH display can show active alarms coming from either NMEA 2000, SAE J1939, or from the analogue sensors directly connected to it. Engine alarms concern all engines on the network.



## MENU STRUCTURE

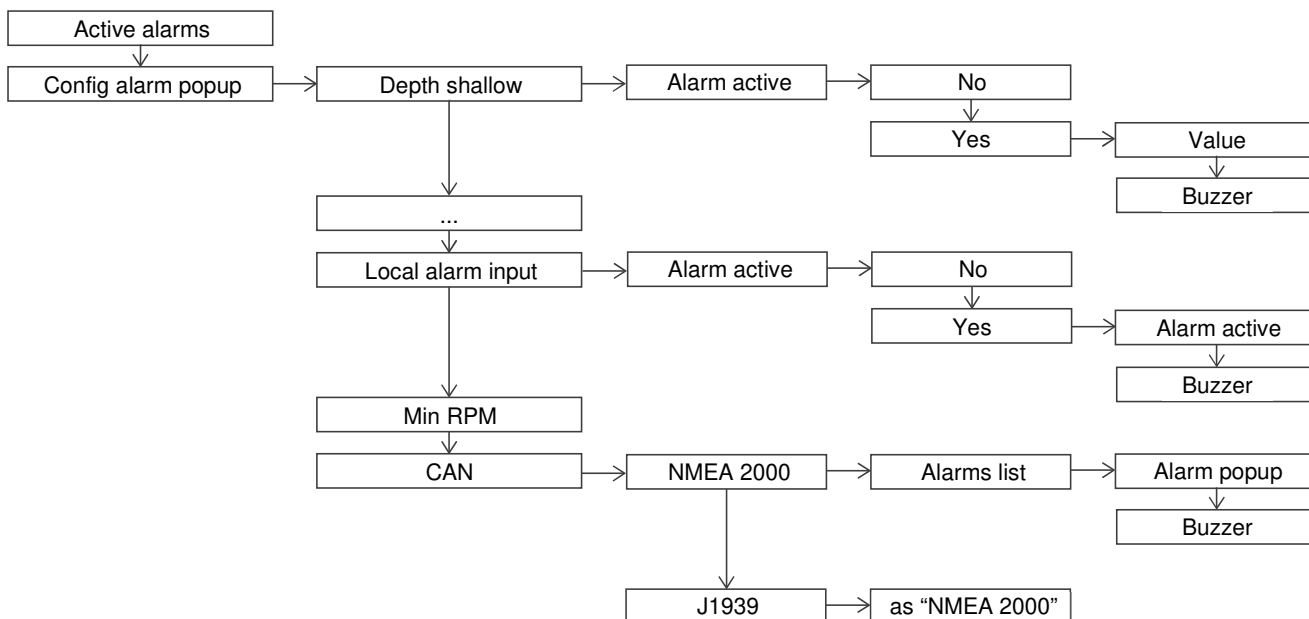

## ALARMS NOTIFICATION

In the event of an alarm, the following appears on the display:

- The alarm pop-up appears
- The buzzer gets activated, if connected and configured to do so
- The active alarm, including additional information, is visible in the Active alarms screen
- If supported, the local alarm is transmitted to the NMEA 2000 network



## ACKNOWLEDGE AN ALARM

When an alarm is triggered, the Alarm notification pop-up appears and the buzzer sounds (if connected and configured).

To acknowledge the alarm and mute the buzzer, press the touchscreen: the pop-up notification is closed, and the alarm is saved in the Active alarms screen.





The alarm remains displayed in the Active alarms screen as long as it remains active, and a warning icon is displayed in the bottom side of every screen to remind you that an alarm is currently active.

## ACTIVE ALARMS

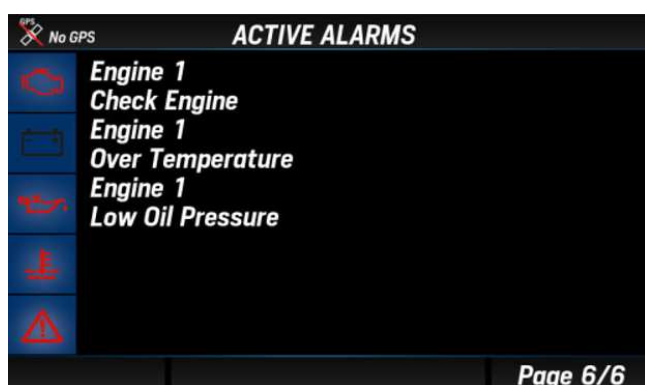
If at least one alarm is active, an "Active alarm" screen will appear after the last screen. The same screen can be accessed via [ALARMS] > [Active alarms].

All the currently active alarms are listed here, together with some warning symbols.



| Symbol  | Description              |
|---|--------------------------|
|  | Engine alarms            |
|  | Battery alarms           |
|  | Oil alarms               |
|  | Engine temperature alarm |
|  | Generic alarm            |

**CONFIGURE A LOCAL ALARM**

1. Press the MENU button and select [ALARMS] > [Setup]
2. Select one of the supported alarms
3. Activate it by selecting [Active] > [Yes], the alarm parameters will appear
4. Then select and edit the threshold(s) and enable/disable the buzzer

| Setting             | Description   | Possible values             | NMEA 2000 output |
|---------------------|---|-----------------------------|------------------|
| Depth shallow       | Shallow water alarm.  | 0 – 9.9 m (2m)              | No               |
| Depth navigation    | Depth navigation alarms.<br>Deep water alarm (e.g., a value near the maximum value measurable by the sensor) and safety depth minimum threshold.  | 0 – 99.9 m<br>(50m, 5m)     | No               |
| Wind                | High wind speed.  | 0 – 99.9 km/h<br>(39.9km/h) | No               |
| Battery voltage     | Low battery voltage.  | 0 – 32.9 V (10.8V)          | Yes              |
| Battery Temperature | High battery temperature.   | 0 – 99 °C (50°C)            | No               |
| Battery Charge      | Low battery state of charge.  | 0 – 99 % (50%)              | No               |
| Engine water temp   | High engine coolant temperature.  | 0 – 139 °C (110°C)          | Yes              |
| Engine oil temp     | High engine oil temperature.  | 0 – 149 °C (120°C)          | Yes              |
| Engine oil pressure | Low engine oil pressure.  | 0 – 9.9 bar (0.5bar)        | Yes              |
| Exhaust Gas Temp    | High EGT.   | 0 – 899 °C<br>(500°C)       | Yes              |
| Fuel                | Low fuel level.   | 0 – 99 % (20%)              | No               |
| Fresh water         | Low fresh water level.  | 0 – 99 % (20%)              | No               |
| Waste water         | High waste water level.   | 0 – 99 % (80%)              | No               |
| Local alarm input   | External digital switch (low active alarm).<br>Refer to “Connections’ diagram”.<br><br>The name of the alarm triggered can be configured in the Veratron Configuration Tool.<br>Contact your dealer for more information. | -                           | No               |
| Min RPM             | Engine related alarms are only triggered when the engine speed exceeds this threshold.  | 0 – 990 RPM<br>(300RPM)     | -                |



## CONFIGURE A CAN ALARM

1. Press the MENU button and select [ALARMS] > [Setup]
2. Select [CAN] and then the [NMEA 2000] or [SAE J1939]
3. Choose the alarm to activate and select [Active] > [Yes], the alarm parameters will appear
4. If necessary, enable/disable the buzzer

| <b>NMEA 2000 alarms</b><br>Engine (PGN 127489)  | <b>NMEA 2000 alarms</b><br>Transmission (PGN 127493)   | <b>SAE J1939 alarms</b><br>(DM1)  |
|---|--|---|
| Check engine<br>Over temperature<br>Low oil pressure<br>Low oil level<br>Low fuel pressure<br>Low system voltage<br>Low coolant level<br>Water flow<br>Water in fuel<br>Charge indicator<br>Preheat indicator<br>High boost pressure<br>Rev limit exceeded<br>EGR system<br>Throttle position sensor<br>Engine emergency stop<br>Warning level 1<br>Warning level 2<br>Power reduction<br>Maintenance needed<br>Eng com error<br>Sub or secondary throttle<br>Neutral start protect<br>Engine shutting down | Check transmission<br>Transm. over temp<br>Transm. low oil pressure<br>Transm. low oil level<br>Transm. sail drive | Engine speed<br>Boost pressure<br>Exhaust gas temperature<br>Engine oil pressure<br>Engine coolant pressure<br>Engine coolant temp<br>Engine oil temp<br>Transmission oil press<br>Transmission oil temp<br>Fuel Level<br>Water in fuel |

# TROUBLESHOOTING

| Problem   | Root cause  | Solution   |
|---|---|--|
| The values displayed are not as expected.   | Incorrect sensor configuration.   | Check the configuration in the Sensors menu.   |
|   | Sensor connected incorrectly.   | Check the connection, refer to the Installation Instructions.  |
|   | The NMEA 2000 network backbone has not been created correctly.                                | Check the connections and that there is a termination at both the beginning and end of the backbone. |
| "--" is displayed for a certain data or the pointer blinks in the NavDash layout. | The data is not available on the network.   | Check that the device sending this information is functioning correctly.                             |
|   | Sensor not connected.   | Connect the sensor, refer to the Installation Instructions.  |
|   | The NMEA 2000 network backbone has not been created correctly.                                | Check the connections and that there is a termination at both the beginning and end of the backbone. |
| The same data is displayed with two different alternating values.                 | Incorrect sensor configuration. Two different sources are sending the same data on NMEA 2000. | Check the engine/tank IDs (Show value as) in the sensor configuration.                               |

# TECHNICAL DATA

## GENERAL FEATURE

|  |  |
|--|--|
| <b>Material</b>  | Aluminum case<br>PC-FR back cover<br>Mineral glass front screen  |
| <b>Display</b>   | IPS TFT 7" – 800x480 – Transmissive touch screen<br>Full 24 bit / 16 mio. colors   |
| <b>Connectors</b>  | <ul style="list-style-type: none"> <li>• 2x Molex MX150 12 pin</li> <li>• 1x NMEA 2000 Micro-C M12 5 pin</li> <li>• 2x AMP SuperSeal 1.5 Series (EasyLink)</li> <li>• 1x M12 4 pins "D" coding (Video)</li> </ul>  |
| <b>Input data</b>  | <ul style="list-style-type: none"> <li>• CAN (NMEA 2000 and SAE J1939)</li> <li>• 6x resistive inputs (0-400 <math>\Omega</math>)</li> <li>• 2x capacitive inputs (4-20mA)</li> <li>• 2x frequency inputs (0-4 kHz)</li> <li>• 3x voltage inputs (0-5V)</li> <li>• 1x digital alarm input</li> </ul> |
| <b>Output data</b>                                       | <ul style="list-style-type: none"> <li>• NMEA 2000</li> <li>• 2x EasyLink</li> <li>• 2x Alarm outputs (500mA max)</li> </ul>   |
| <b>Degree of protection<br/>(according to IEC 60529)</b> | IPX7   |

## ENVIRONMENTAL FEATURES

|                              |                    |
|------------------------------|--------------------|
| <b>Operating temperature</b> | From -25 to +70 °C |
| <b>Storage temperature</b>   | From -40 to +85 °C |

## ELECTRICAL FEATURES

|                            |   |
|----------------------------|---|
| <b>Rated voltage</b>       | 12/24 V   |
| <b>Operating voltage</b>   | 9–32 V  |
| <b>Current consumption</b> | < 900 mA @ 12 V (display only)<br>100mA for each EasyLink satellite gauge |
| <b>Absorption (LEN)</b>    | 2   |

**COMPLIANCE**

|                            |  |
|----------------------------|--|
| <b>Compliance</b>          | CE, UKCA, Reach, RoHS, UL94  |
| <b>Directives</b>          | 2014/30/EU (Electromagnetic compatibility)<br>2011/65/EU (Hazardous substances in electrical and electronic equipment) |
| <b>Reference standards</b> | IEC 60945: 2002-08 (environmental class: exposed)  |

**SUPPORTED NMEA 2000 MESSAGES**

| Description                                 | PGN    | Description                             | PGN                |
|---|--------|---|--------------------|
| J1939 Generator Average Basic AC Quantities | 65030  | Water depth                             | 128267             |
| J1939 Diagnostic Message #1                 | 65226  | Position: Rapid update                  | 129025             |
| J1939 Diagnostic Message #2                 | 65227  | COG and SOG: Rapid update               | 129026             |
| J1939 Diagnostic Message #3                 | 65228  | GNSS position data                      | 129029             |
| J1939 Diagnostic Message #4                 | 65229  | Local Time Offset                       | 129033             |
| J1939 Diagnostic Message #5                 | 65230  | Datum                                   | 129044             |
| J1939 Diagnostic Message #6                 | 65231  | Cross track error                       | 129283             |
| J1939 Diagnostic Message #8                 | 65232  | Navigation data                         | 129284             |
| J1939 Diagnostic Message #10                | 65234  | Navigation route and waypoint info      | 129285             |
| J1939 Diagnostic Message #11                | 65235  | GNSS dilution of precision (DOP)        | 129539             |
| J1939 Diagnostic Message #12                | 65236  | GNSS satellites in view                 | 129540             |
| System time                                 | 126992 | Wind data                               | 130306             |
| Rudder                                      | 127245 | Environmental parameters                | 130310             |
| Vessel heading                              | 127250 | Environmental parameters                | 130311             |
| Rate of Turn                                | 127251 | Temperature                             | 130316<br>(130312) |
| Attitude                                    | 127257 | Humidity                                | 130313             |
| Temperature (Old Version)                   | 127258 | Actual Pressure                         | 130314             |
| Engine Parameters, Rapid Update             | 127488 | Entertainment - Current File and Status | 130569             |
| Engine Parameters, Dynamic                  | 127489 | Entertainment - Data File               | 130570             |
| Transmission Parameters, Dynamic            | 127493 | Entertainment - Data Group              | 130571             |
| Engine Parameters, Static                   | 127498 | Entertainment - Data Search             | 130572             |
| Fluid level                                 | 127505 | Entertainment - Supported Source Data   | 130573             |
| DC Detailed Status                          | 127506 | Entertainment - Supported Zone Data     | 130574             |
| Battery status                              | 127508 | Small Craft Status                      | 130576             |
| Speed: Water referenced                     | 128259 |   |                    |

**DISPOSAL RESPONSIBILITY**



Dispose of by separate collection through government or local government designated collection facilities.

Proper disposal and recycling will help prevent potentially negative consequences for the environment and people.

# SPARE PARTS AND ACCESSORIES

## SPARE PARTS

| Product                         | Part Number   |
|---------------------------------|---------------|
| Power and data cable - Engine 1 | A2C1507870001 |
| Data cable - Engine 2           | A2C1992110001 |
| EasyLink extension cable        | A2C59500139   |
| Video input cable 0.3m          | A2C1845710001 |
| Sun cover                       | B00134401     |
| Mounting kit                    | B00067201     |

## ACCESSORIES

| Product                       | Part Number   |
|-------------------------------|---------------|
| VMH 14                        | B00109901     |
| NMEA 2000 Power Cable         | A2C3931290001 |
| NMEA 2000 T-splitter          | A2C3931270002 |
| NMEA 2000 drop cable - 0.5m   | A2C9624370001 |
| NMEA 2000 drop cable - 2m     | A2C9624380001 |
| NMEA 2000 drop cable - 6m     | A2C9624400001 |
| NMEA 2000 terminator - Male   | A2C3931100001 |
| NMEA 2000 terminator - Female | A2C3931060001 |

For all available accessories, visit [www.Veratron.com](http://www.Veratron.com).



**Veratron AG**  
Industriestrasse 18  
9464 Rüthi, Switzerland

T +41 71 7679 111  
info@Veratron.com  
Veratron.com

---

Any distribution, translation, or reproduction of this document, in whole or in part, is strictly prohibited without the prior written permission of Veratron AG, except as noted below:

- Print the document in its original format, in whole or in part.
- Copy of contents without modification and declaration of Veratron AG as copyright owner.

Veratron AG reserves the right to make changes or improvements to this documentation without notice.

Requests for permission, additional copies of this manual, or technical information about this manual should be directed to Veratron AG.

# VMH 70 MARINE ANZEIGE

BEDIENUNGSANLEITUNG  
rev. AD

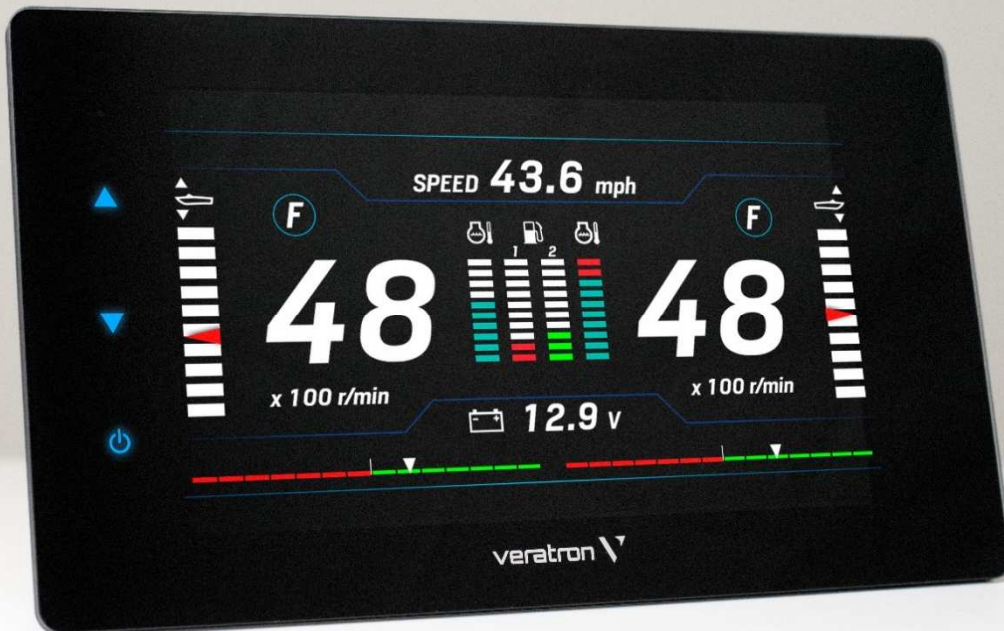

EN

DE

IT

FR

ES

# INHALTSVERZEICHNIS

|   |           |   |           |
|---|-----------|---|-----------|
| <b>EINFÜHRUNG .....</b>                     | <b>3</b>  | Motorstunden .....                            | 24        |
| Architektur .....                           | 3         | Zurückgelegte Entfernung .....                | 24        |
| <b>SICHERHEITSHINWEISE .....</b>            | <b>4</b>  | NavDash Layout.....                           | 24        |
| Während des Einbaus beachten .....          | 4         | <b>BILDSCHIRMKONFIGURATION.....</b>           | <b>25</b> |
| Nach dem Einbau beachten .....              | 5         | <b>SYSTEMEINSTELLUNGEN .....</b>              | <b>27</b> |
| Elektrischer Anschluss.....                 | 5         | Menüstruktur.....                             | 27        |
| <b>INSTALLATION .....</b>                   | <b>7</b>  | System Configurations Menü-Bedienung.....     | 28        |
| Vor der Installation .....                  | 7         | Einheiten.....                                | 30        |
| Panel-Montage.....                          | 8         | SAE J1939-Gateway.....                        | 30        |
| <b>ELEKTRISCHE ANSCHLÜSSE .....</b>         | <b>10</b> | <b>SENSOR-KONFIGURATIONEN .....</b>           | <b>31</b> |
| Motor Stecker 1 [A].....                    | 10        | Menüstruktur.....                             | 31        |
| Motor Stecker 2 [B].....                    | 11        | Konfigurieren eines an das Display            |           |
| EasyLink-Steckverbinder [C].....            | 11        | angeschlossenen Sensors .....                 | 32        |
| NMEA 2000®-Anschluss [D].....               | 12        | Kalibrierung des Kraftstoffstandssensors..... | 34        |
| Video-Eingang-Anschluss [E] .....           | 12        | Kalibrierung anderer Sensoren .....           | 34        |
| Elektrischer Schaltplan.....                | 13        | Benutzerdefinierte Sensorkonfiguration .....  | 35        |
| Anschluss des Drehzahlsensors.....          | 14        | Standard-Kalibrierungen.....                  | 36        |
| Resistiver Sensoranschluss.....             | 15        | Einstellen des                                |           |
| Anschluss für externen Buzzer (B1) .....    | 15        | Geschwindigkeitskorrekturfaktors .....        | 37        |
| Wahlschalter für Tag/Nacht-Modus (S1) ..... | 15        | <b>ALARME .....</b>                           | <b>38</b> |
| Priorität von Datenquellen .....            | 16        | Menüstruktur.....                             | 38        |
| <b>ERSTE SCHRITTE.....</b>                  | <b>17</b> | Alarmer Benachrichtigung .....                | 38        |
| Konzept Bedienung.....                      | 17        | Einen Alarm quittieren.....                   | 39        |
| Standby-Modus.....                          | 17        | Aktive Alarmer .....                          | 39        |
| Einschalten und Ausschalten.....            | 17        | Einen lokalen Alarm konfigurieren.....        | 40        |
| Funktionen der Menütasten.....              | 18        | Konfigurieren eines CAN-Alarms.....           | 41        |
| Touch-Button-Funktionen .....               | 18        | <b>FEHLERSUCHE.....</b>                       | <b>42</b> |
| Kalibrierungs-Assistent.....                | 18        | <b>TECHNISCHE DATEN.....</b>                  | <b>43</b> |
| Einstellen des Tag/Nacht-Modus.....         | 19        | Allgemeines.....                              | 43        |
| Checkliste für die Inbetriebnahme.....      | 19        | Umwelt .....                                  | 43        |
| Hochladen eines benutzerdefinierten Splash- |           | Elektrisches .....                            | 43        |
| Logos.....                                  | 19        | Konformität .....                             | 44        |
| <b>DATENSEITEN.....</b>                     | <b>20</b> | Unterstützte NMEA 2000-Nachrichten.....       | 44        |
| Bildschirme blättern .....                  | 20        | Entsorgungsverantwortung.....                 | 44        |
| Bildschirmlayouts.....                      | 20        | <b>ERSATZTEILE UND ZUBEHÖR.....</b>           | <b>45</b> |
| Unterstützte Daten.....                     | 22        |   |           |



# EINFÜHRUNG

Das VMH 70 ist ein multifunktionales Display, das für die Anzeige von Motorendaten auf Booten und zur Navigationshilfe entwickelt wurde.

Bis zu vier Motoren können mit einem einzigen Display überwacht werden.

Mit dem integrierten NMEA 2000-Gateway können Motordaten auch über analoge Sensoren oder SAE J1939 erfasst werden, um die Informationen dann zu konvertieren und über das NMEA 2000-Netzwerk weiterzuleiten.

Das Display verwaltet bis zu sechs Widerstandssensoren, drei Spannungssensoren zwei stromabhängige Eingänge und einen digitalen Alarminput.

Alle Daten werden auch auf zwei EasyLink-Kanälen mit maximal 16 VMH 14 Messgeräten pro Kanal verteilt. Mit der NMEA 2000-Anbindung können Sie Navigationsdaten von anderen Geräten im Netzwerk anzeigen, wie z. B. Wind, Kompass, GPS, Geschwindigkeit und Tiefendaten.



## ARCHITEKTUR

Es folgt ein Beispiel für eine Anwendung mit einem VMH 70-Display, das als Gateway und als NMEA 2000-Monitor verwendet wird.

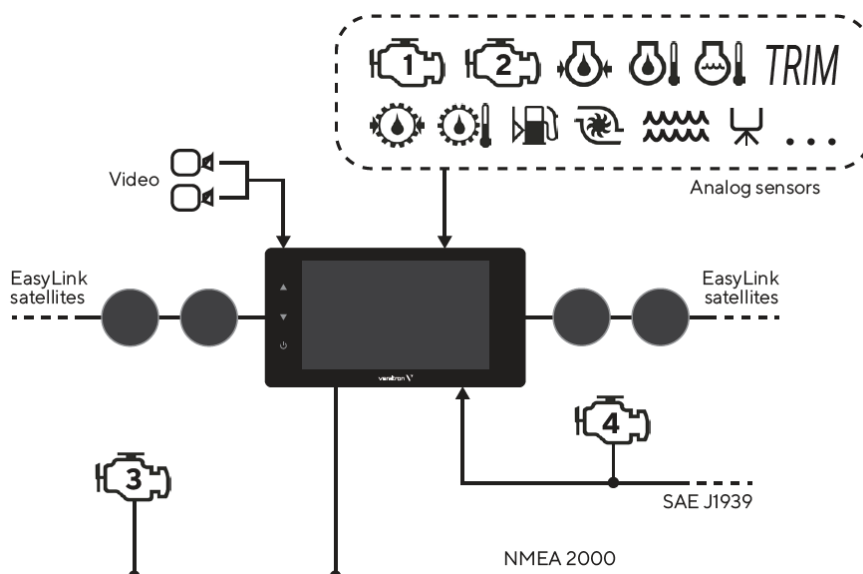

# SICHERHEITSHINWEISE

## WARNUNG

- Nicht rauchen! Kein offenes Feuer oder Wärmequellen!
- Das Produkt wurde unter Beachtung der grundlegenden Sicherheitsanforderungen der EG-Richtlinien und dem anerkannten Stand der Technik entwickelt, gefertigt und geprüft.
- Das Gerät ist für den Einsatz in der Sportschiffahrt konzipiert.
- Das Gerät ist für den Einsatz in erdgebundenen Fahrzeugen und Maschinen sowie den Einsatz in der Sportschiffahrt, inklusive der nicht klassifizierten Berufsschiffahrt bestimmt.
- Setzen Sie unser Produkt nur bestimmungsgemäss ein. Die Folgen einer nicht bestimmungsgemässen Verwendung des Produktes können Personenschäden sowie Sachschäden oder Umweltschäden sein. Informieren Sie sich vor dem Einbau anhand der Fahrzeug-Papiere über den Fahrzeugtyp und über eventuelle Besonderheiten!
- Informieren Sie sich anhand von Bauplänen über die Lage von Kraftstoff- /Hydraulik- /Druckluft und elektrischen Leitungen!
- Beachten Sie eventuelle Veränderungen am Fahrzeug, die beim Einbau zu berücksichtigen sind!
- Für den Einbau sind Grundkenntnisse der Kfz/Schiffbau-Elektrik und -Mechanik erforderlich, um Personenschäden, Sachschäden oder Umweltschäden zu vermeiden.
- Stellen Sie sicher, dass kein unbeabsichtigter Motorstart während des Einbaus ausgeführt werden kann!
- Veränderungen oder Manipulationen am Veratronprodukt können die Sicherheit beeinflussen. Es darf deshalb nicht verändert oder manipuliert werden!
- Beim Aus-/Einbau von Sitzen, Abdeckungen o. ä. darauf achten, dass Sie keine Leitungen beschädigen oder Steckverbindungen lösen!
- Alle Daten von anderen installierten Geräten mit flüchtigen elektronischen Speichern notieren.

## WÄHREND DES EINBAUS BEACHTEN

- Achten Sie beim Einbau darauf, dass die Komponenten des Produkts die Fahrzeugfunktionen nicht beeinflussen oder behindern und selbst nicht beschädigt werden!
- Bauen Sie nur unbeschädigte Teile in ein Fahrzeug ein!
- Achten Sie beim Einbau darauf, dass durch das Produkt der Sichtbereich nicht beeinträchtigt wird und das Produkt nicht im Kopfaufschlagbereich des Fahrers und Beifahrers positioniert wird!
- Den Einbau des Produktes sollten Sie von einem darauf spezialisierten Fachmann ausführen lassen. Wenn Sie den Einbau selbst vornehmen, tragen Sie geeignete Arbeitskleidung. Tragen Sie keine weite Kleidung. Sie kann von beweglichen Teilen erfasst werden. Tragen Sie bei langen Haaren ein Haarnetz. Bei Arbeiten an der Bordelektrik keinen metallischen oder leitfähigen Schmuck wie Ketten, Armbänder, Ringe etc. tragen.
- Falls notwendige Arbeiten am laufenden Motor erforderlich sind, besondere Vorsicht walten lassen. Tragen Sie nur entsprechende Arbeitskleidung, da Verletzungsgefahr durch Quetschungen und Verbrennungen besteht. Vor Beginn der Arbeiten ist der Minuspol der Batterie abzuklemmen, da sonst Kurzschlussgefahr besteht. Wenn das Fahrzeug über Zusatzbatterien verfügt, müssen ggf. auch die Minuspole dieser Batterien abgeklemmt werden! Kurzschlüsse können Kabelbrände, Batterieexplosionen und Beschädigungen von anderen elektronischen Systemen verursachen. Bitte beachten Sie, dass beim Abklemmen der Batterie alle flüchtigen elektronischen Speicher ihre

## SICHERHEITSHINWEISE

- eingegebenen Werte verlieren und neu programmiert werden müssen.
- Lassen Sie bei Bootsmotoren vor Beginn der Arbeiten im Motorraum bei Benzinmotoren den Motorraumlüfter laufen.
- Achten Sie auf den Verlauf von Leitungen oder Kabelsträngen, um diese bei Bohr- und Sägearbeiten nicht zu beschädigen!
- Den Einbauort nicht im mechanischen und elektrischen Airbag-Bereich wählen!
- Bohrungen und Einbauöffnungen nicht in tragende oder stabilisierende Streben oder Holme anbringen!
- Bei Arbeiten unter dem Fahrzeug, dieses nach Vorschrift des Fahrzeugherstellers sichern.
- Beim Einbauort auf den nötigen Freiraum hinter den Bohrungen oder der Einbauöffnung achten. Notwendige Einbautiefe 65 mm.
- Einbauöffnungen klein vorbohren, mit Konusfräser, Loch-, Stichsäge oder Feile gegebenenfalls vergrößern und fertig stellen. Kanten entgraten. Unbedingt die Sicherheitshinweise der Handwerkzeughersteller beachten.

## NACH DEM EINBAU BEACHTEN

- Massekabel an den Minuspol der Batterie fest anklemmen.
- Werte der flüchtigen elektronischen Speicher neu eingeben/programmieren.

## ELEKTRISCHER ANSCHLUSS

- Kabelquerschnitt beachten!
- Eine Verringerung des Kabelquerschnitts führt zu einer höheren Stromdichte. Dies kann zu einer Erhitzung des betreffenden Kabelabschnitts führen!
- Bei der elektrischen Kabelverlegung benutzen Sie vorhandene Kabelkanäle und Kabelstränge, führen Sie die Kabel jedoch nicht parallel zu Zündkabeln oder parallel zu Kabeln, die zu grossen Stromverbrauchern führen.
- Fixieren Sie die Kabel mit Kabelbindern oder Klebeband. Führen Sie die Kabel nicht über bewegliche Teile. Kabel nicht an der Lenksäule befestigen!
- Achten Sie darauf, dass die Kabel keinen Zug-, Druck- oder Scherkräften ausgesetzt sind.

- Bei notwendigen Arbeiten ohne Spannungsunterbrechung darf nur mit isoliertem Werkzeug gearbeitet werden.
- Benutzen Sie zum Messen von Spannungen und Strömen im Fahrzeug/ Maschine bzw. Schiff nur dafür vorgesehene Multimeter oder Diodenprüflampen. Die Benutzung herkömmlicher Prüflampen kann die Beschädigung von Steuergeräten oder anderer elektronischer Systeme zur Folge haben.
- Die elektrischen Ausgänge des Anzeigergerätes und daran angeschlossene Kabel müssen vor direkter Berührung und Beschädigung geschützt werden. Dazu müssen die verwendeten Kabel eine ausreichende Isolation bzw. Spannungsfestigkeit besitzen und die Kontaktstellen berührungssicher sein.
- Auch die elektrisch leitenden Teile der angeschlossenen Verbraucher sind durch entsprechende Massnahmen vor direkter Berührung zu schützen. Das Verlegen metallisch blanker Kabel und Kontakte ist nicht zulässig.

- Prüfen Sie alle Funktionen.
- Zur Reinigung der Komponenten nur klares Wasser verwenden. IP-Schutzarten (IEC 60529) beachten.

- Wenn die Kabel durch Bohrungen geführt werden, schützen Sie die Kabel mittels Gummitüllen oder ähnlichem.
- Benutzen Sie zum Abisolieren der Kabel nur eine Abisolierzange. Stellen Sie die Zange so ein, dass keine Litzen beschädigt oder abgetrennt werden.
- Verlöten Sie neu zu schaffende Kabelverbindungen nur im Weichlötverfahren oder verwenden Sie handelsübliche Quetschverbinder!
- Nehmen Sie Quetschverbindungen nur mit einer Kabelquetschzange vor. Achten Sie auf die Sicherheitshinweise der Handwerkzeughersteller.
- Isolieren Sie freigelegte Litzen so, dass keine Kurzschlüsse entstehen können.

## **SICHERHEITSHINWEISE**

- **Achtung:** Kurzschlussgefahr durch fehlerhafte Verbindungsstellen oder beschädigte Kabel.
  - Kurzschlüsse im Bordnetz können Kabelbrände, Batterieexplosionen und Beschädigungen anderer elektronischer Systeme verursachen. Deshalb müssen alle Verbindungen der Spannungsversorgung mit verschweisbaren Stossverbindern versehen und ausreichend isoliert sein.
- Achten Sie besonders auf einwandfreie Masseverbindungen.
  - Falschanschlüsse können zu Kurzschlüssen führen. Schliessen Sie die Kabel nur entsprechend dem elektrischen Anschlussplan an.
  - Bei Betrieb des Gerätes an Netzteilen beachten Sie, dass das Netzteil stabilisiert sein muss und den folgenden Normen entsprechen muss: DIN EN 61000- Teil 6-1 bis 6-4.

# INSTALLATION

## ⚠️ WARNUNG

Vor Beginn der Arbeiten ist der Minuspol der Batterie abzuklemmen, da sonst Kurzschlussgefahr besteht. Wenn das Fahrzeug über Zusatzbatterien verfügt, müssen ggf. auch die Minuspole dieser Batterien abgeklemmt werden! Kurzschlüsse können Kabelbrände, Batterieexplosionen und Beschädigungen von anderen elektronischen Systemen verursachen. Bitte beachten Sie, dass beim Abklemmen der Batterie alle flüchtigen elektronischen Speicher ihre eingegebenen Werte verlieren und neu programmiert werden müssen.

## VOR DER INSTALLATION

1. Vor Beginn der Arbeiten die Zündung ausschalten und den Zündschlüssel abziehen. Ggf. den Hauptstromschalter unterbrechen.

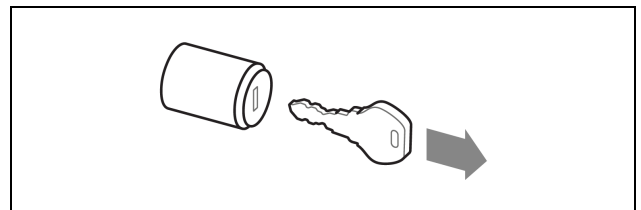

2. Den Minuspol der Batterie abklemmen und gegen versehentliches Wiederverbinden schützen.

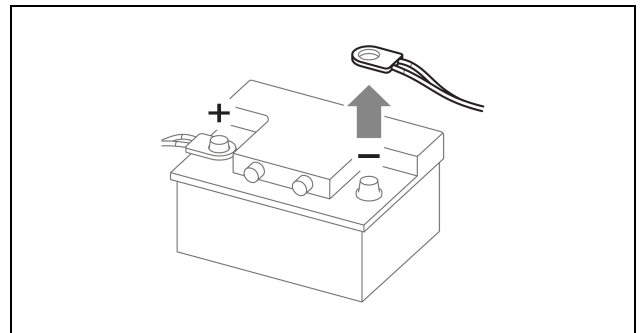

3. Den magnetischen Schutzabstand von mindestens 300mm zu nächstem Magnetkompass beachten.

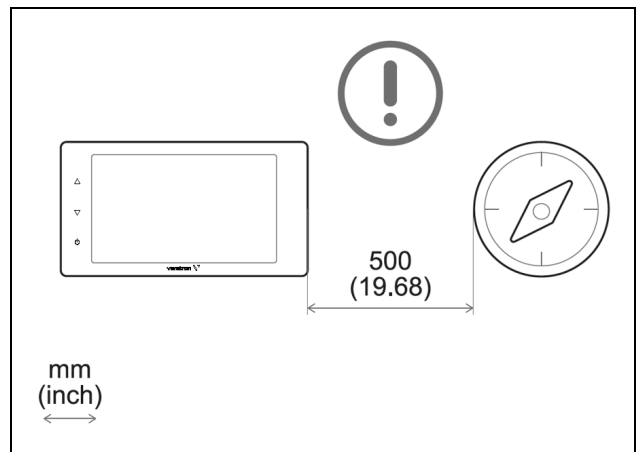

4. Falls für Ihr System benötigt, kaufen Sie ein NMEA2000-Drop-Kabel mit fünfpoligem M12-Stecker (maximale Länge des Drop-Kabels 6 m) und ein Videokabel mit einem kompatiblen vierpoligen M12-Stecker (A2C1845710001). Diese sind nicht im Paket enthalten.

## PANEL-MONTAGE

**! WARNUNG**

- Bohren Sie keine Löcher oder Montageöffnungen in tragende oder stabilisierende Elemente!
- Der Montageort muss einen ausreichenden Freiraum hinter den Montagebohrungen aufweisen.

1. Mit Hilfe der Schablone (siehe nächste Seite) und unter Berücksichtigung der Geräteabmessungen [A] ein rechteckiges Loch in die Platte einarbeiten.
2. Die vier Madenschrauben in die Rückseite des Displays drehen.
3. Führen Sie die Kabel von hinten durch das Loch und schliessen Sie die Stecker an.

**HINWEIS:** Schrauben Sie die M12-Steckverbinder mit Sorgfalt ein. Wenn sie sich nur schwer einschrauben lassen, entfernen Sie sie und schrauben Sie sie erneut ein.

4. Setzen Sie das Gerät von vorne ein und ziehen Sie die vier Muttern an der Oberseite der Kunststoffklammern fest, um das Display zur Platte hinzuziehen.
5. Entfernen Sie die Schutzfolie vom Display und stellen Sie sicher, dass es sauber und trocken ist.

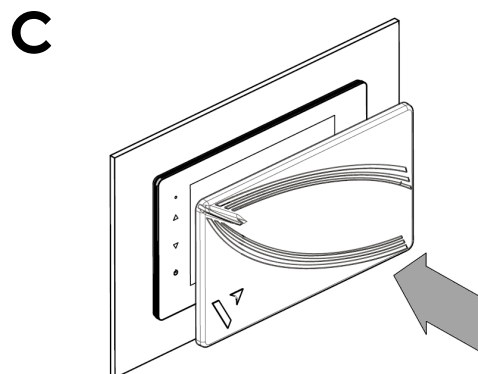
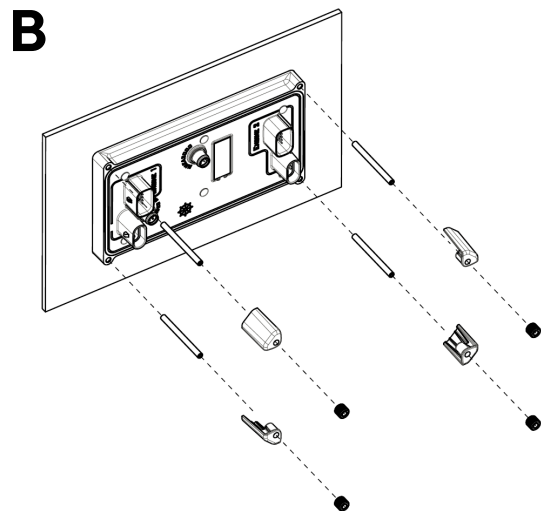
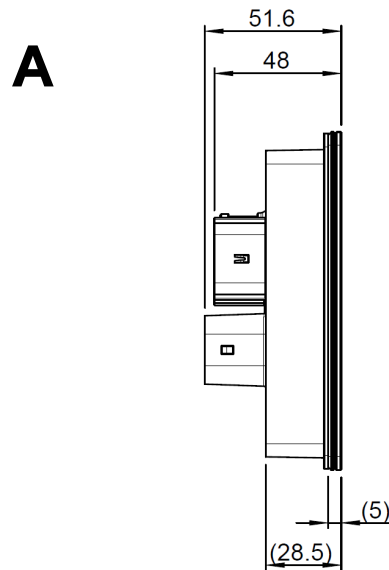

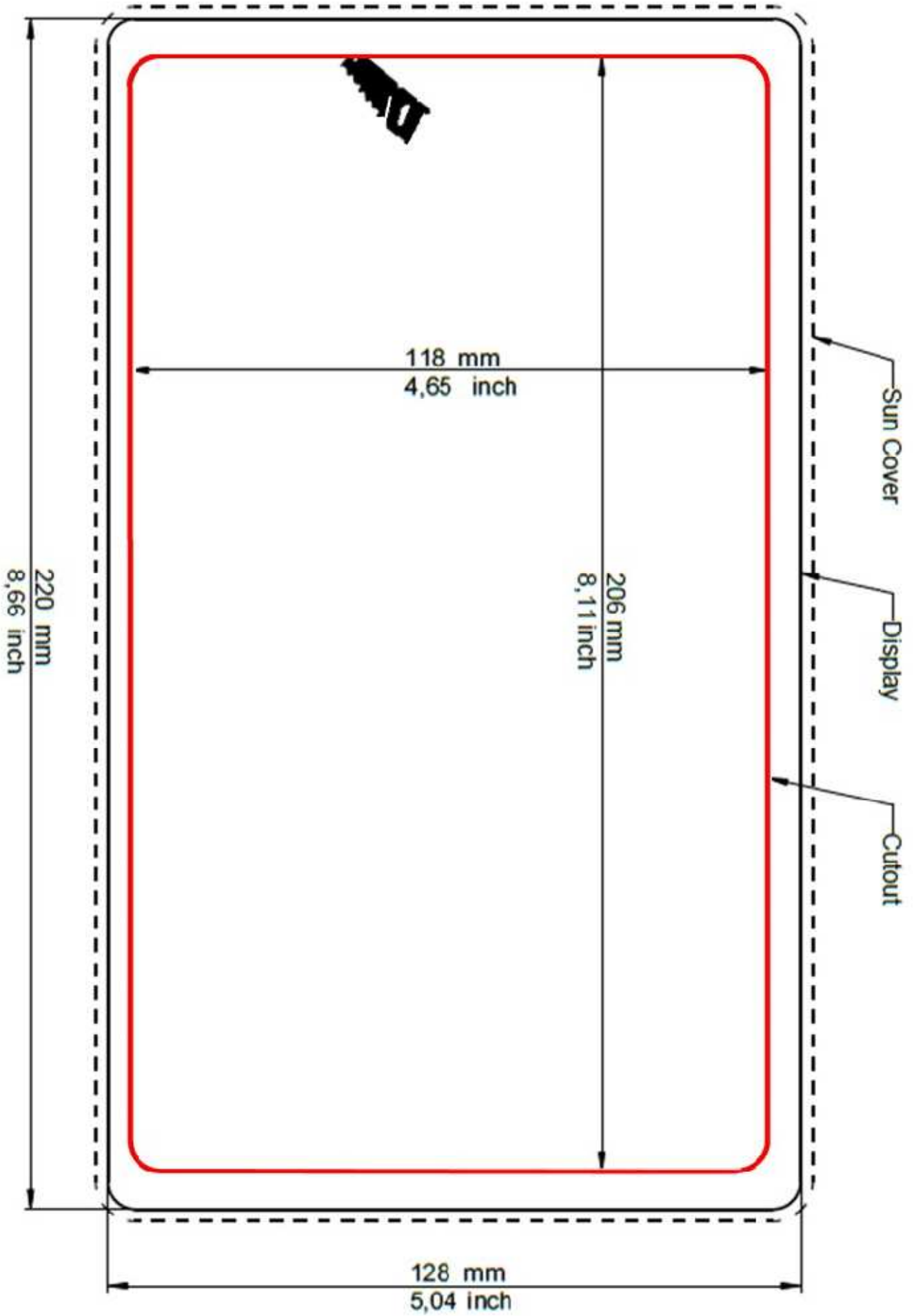

# ELEKTRISCHE ANSCHLÜSSE

## ⚠️ WARNUNG

- Beachten Sie die Sicherheitsvorschriften, die im Abschnitt "Elektrische Anschlüsse" des Kapitels "Sicherheitshinweise" in diesem Dokument beschrieben sind!

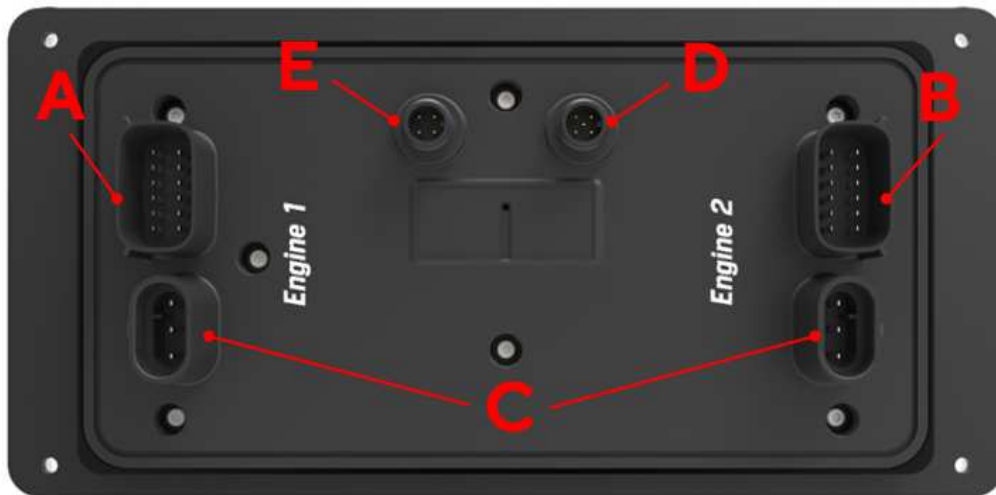

### MOTOR STECKER 1 [A]

| Pin Nr. | Kabelfarbe   | Beschreibung                     |
|---------|--------------|----------------------------------|
| 1       | Rot          | KL. 30 - Batterie Plus 12 / 24 V |
| 2       | Schwarz      | KL. 31 - Masse                   |
| 3       | Weiss        | Alarm-Ausgang                    |
| 4       | Grün         | Frequenzsensor-Signal - Drehzahl |
| 5       | Blau         | SAE J1939 - CAN Low              |
| 6       | Blau / Weiss | SAE J1939 - CAN High             |
| 7       | Gelb         | KL. 15 - Zündung Plus            |
| 8       | Grau         | Resistiver Sensoreingang         |
| 9       | Braun        | Resistiver Sensoreingang         |
| 10      | Orange       | 0-5 V Sensoreingang              |
| 11      | Hellblau     | 4-20 mA Sensor-Eingang           |
| 12      | Violett      | 4-20 mA Sensor-Eingang           |

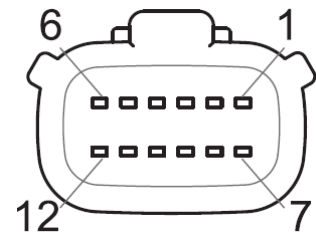

Molex MX150 12-poliger Steckverbinder,  
Kabelansicht  
und Kabelbaum A2C1507870001 (im  
Lieferumfang enthalten)



**MOTOR STECKER 2 [B]**

| Pin Nr. | Kabelfarbe   | Beschreibung                    |
|---------|--------------|---------------------------------|
| 1       | Rosa         | Personalisierbarer Alarmeingang |
| 2       | Schwarz      | KL. 31 - Masse                  |
| 3       | Weiss        | Alarm-Ausgang                   |
| 4       | Grün         | Frequenzsensor-Signal - RPM     |
| 5       | Blau         | SAE J1939 - CAN Low             |
| 6       | Blau / Weiss | SAE J1939 - CAN High            |
| 7       | Gelb         | 0-5 V Sensoreingang             |
| 8       | Grau         | Resistiver Sensoreingang        |
| 9       | Braun        | Resistiver Sensoreingang        |
| 10      | Orange       | 0-5 V Sensoreingang             |
| 11      | Hellblau     | Resistiver Sensoreingang        |
| 12      | Violett      | Resistiver Sensoreingang        |

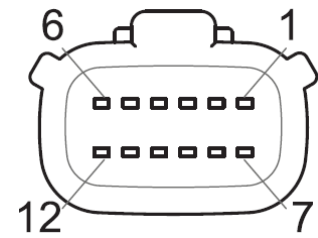

Molex MX150 12-poliger Steckverbinder, Kabelansicht und Kabelbaum A2C1507870001 (im Lieferumfang enthalten)

**EASYLINK-STECKVERBINDER [C]**

| Pin Nr. | Beschreibung   |
|---------|----------------|
| 1       | +12V           |
| 2       | Masse          |
| 3       | EasyLink-Daten |

Die EasyLink-Schnittstelle ist für den Anschluss von VMH 14-Satelliten vorgesehen.

Es ist möglich, pro Kanal bis zu 16 Anzeigen anzuschliessen, wie in der Abbildung rechts dargestellt. (Daisy-Chain).

Jeder Kanal kann die Daten von einem Motor ausgeben. Der angezeigte Motor kann unter [SYSTEM CONFIGURATIONEN] > [EASYLINK] konfiguriert werden.

OceanLink-Satelliten werden nicht unterstützt.

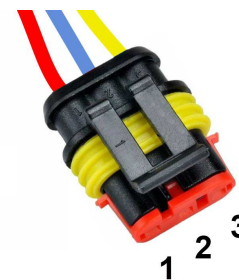

AMP SuperSeal 1.5 3-poliger Stecker Buchse

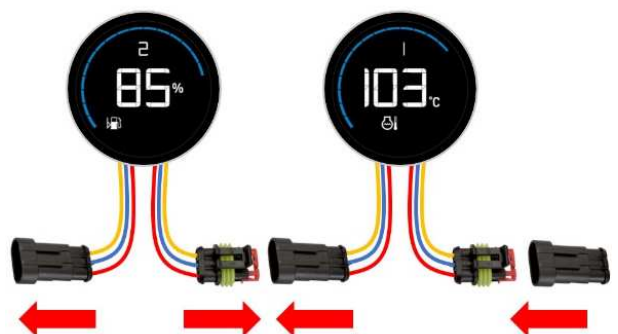

## ELEKTRISCHE ANSCHLÜSSE

### NMEA 2000®-ANSCHLUSS [D]

| Pin Nr. | Beschreibung     |
|---------|------------------|
| 1       | Abschirmung      |
| 2       | NET-S (V+)       |
| 3       | NET-C (V-)       |
| 4       | NET-H (CAN High) |
| 5       | NET-L (CAN Low)  |

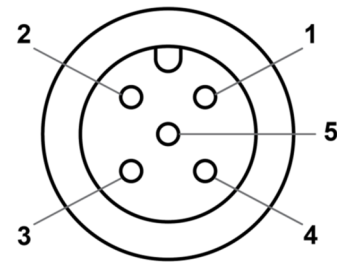

Micro-C M12 5-poliger Stecker  
Stecker, Kabelansicht

Sobald die Installation abgeschlossen ist, können Sie das Gerät über den entsprechenden Anschluss [D] mit dem NMEA 2000® -Netzwerk verbinden.

Achten Sie darauf, dass der M12-Steckverbinder fest auf sein Gegenstück geschraubt wird, um die Wasserdichtigkeit zu gewährleisten.

Ein zusätzliches Drop-Kabel ist erforderlich. (Nicht enthalten)

Bitte beachten Sie, dass NMEA 2000® keine Drop-Kabel von mehr als 6 Metern Länge zulässt.

Beachten Sie den NMEA 2000®-Standard für einen korrekten Netzwerkaufbau.



### VIDEO-EINGANG-ANSCHLUSS [E]

| Pin Nr. | Beschreibung    |
|---------|-----------------|
| 1       | Video-Eingang 2 |
| 2       | Video-Eingang 1 |
| 3       | Masse 2         |
| 4       | Masse 1         |

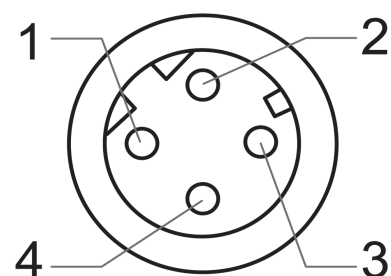

M12 Stecker 4-polig  
Buchse, Kabelansicht

## ELEKTRISCHER SCHALTPLAN

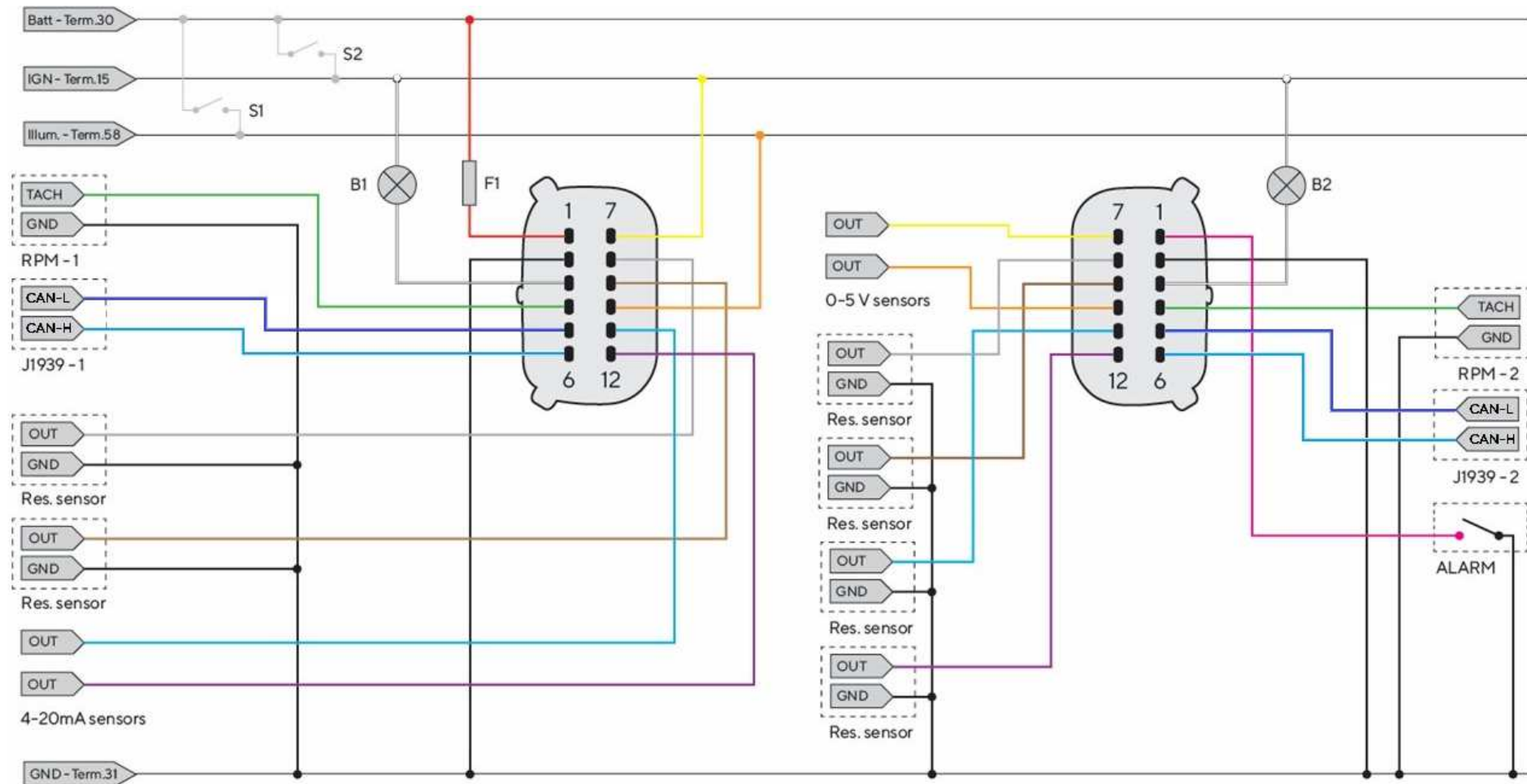

## Bezeichnungen im Schaltplan

**Batt** - KL.30 - Batterie Plus 12/24 V  
**IGN** - KL. 15 - Zündung Plus  
**GND** - KL. 31 - Masse  
**Illum.** - KL.58 - Beleuchtungsstärke positiv

**S1** - Tag/Nacht-Schalter (nicht enthalten)  
**S2** - Zündschloss  
**F1** - 3A-Sicherung (nicht enthalten)  
**B1/B2** - Externer akustischer Alarm (nicht enthalten)

**RES** - Widerstandsabhängige Eingänge  
**RPM** - Frequenzabhängige Eingänge  
**ALARM** - Externer digitaler Alarm  
**J1939** - SAE J1939 CAN-Anschlüsse

## ANSCHLUSS DES DREHZAHLSSENSORS

Das Motordrehzahlsignal kann von verschiedenen Quellen stammen, z. B. von der Klemme "W" der Lichtmaschine, der Klemme "1" der Zündspule oder von spezifischen Sensoren wie einem Drehgeber oder einem induktiven Sensor.

Es ist ratsam, Sensoren mit isolierter Masse zu verwenden, und es muss sichergestellt werden, dass die Sensormasse mit der Anzeigemasse verbunden ist, um falsche Messwerte zu vermeiden.

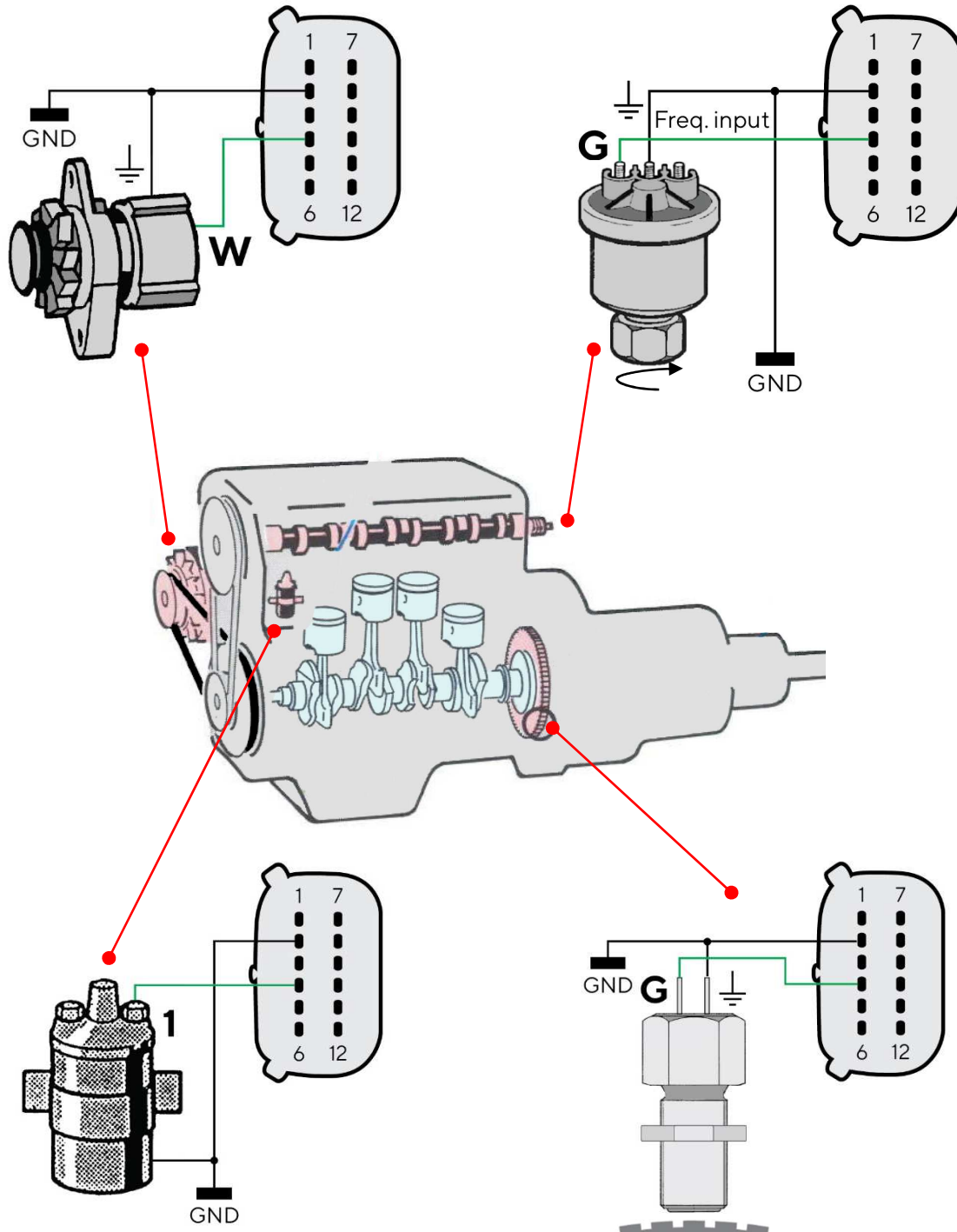

## RESISTIVER SENSORANSCHLUSS

Jeder Sensor, der an einen resistiven Eingang des Displays angeschlossen wird, muss wie in der Abbildung gezeigt angeschlossen sein.

Es ist ratsam, Sensoren mit isolierter Masse zu verwenden, und es muss sichergestellt werden, dass die Sensormasse mit der Anzeigemasse verbunden ist, um falsche Messwerte zu vermeiden.

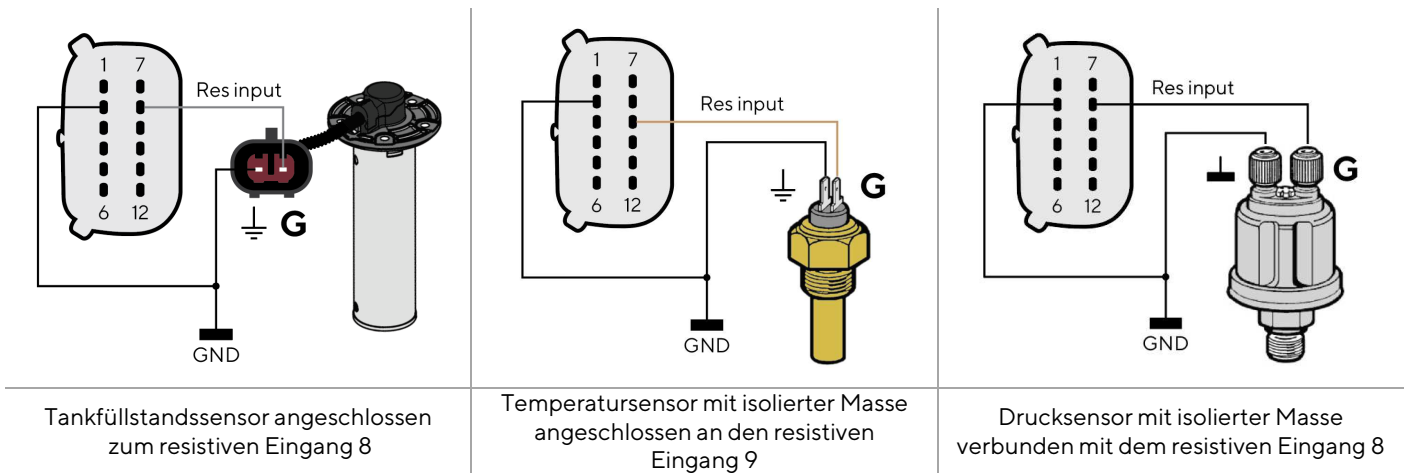

Tankfüllstandsensor angeschlossen zum resistiven Eingang 8

Temperatursensor mit isolierter Masse angeschlossen an den resistiven Eingang 9

Drucksensor mit isolierter Masse verbunden mit dem resistiven Eingang 8

## ANSCHLUSS FÜR EXTERNEN BUZZER (B1)

Das Display unterstützt den Anschluss von zwei externen Alarmen (B1/B2) über die entsprechenden Alarmausgänge.

Dieser Buzzer/Warnleuchte kann mit verschiedenen Spannungen betrieben werden (siehe Anleitung des Buzzer-Herstellers), da der Alarmausgang im Display intern gegen Masse geschaltet wird. (Open-Collector-Ausgang)

**Achtung:** Maximalen Strom vom 500mA nicht überschreiten!

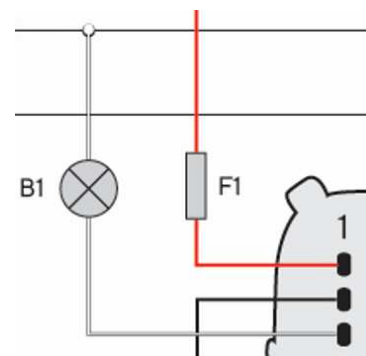

## WAHLSCHALTER FÜR TAG/NACHT-MODUS (S1)

Auf dem Display können Sie zwei Helligkeitsstufen für die Bildschirmbeleuchtung auswählen; eine für Tag und eine für Nacht.

Die Umschaltung zwischen Tag- und Nachtbetrieb kann über einen externen Schalter (S1) gemacht werden, der den Eingang gegen die Stromversorgung (KL.30) schaltet. Oder, falls vorhanden, durch Anschluss an das Lichtsignal an Bord KL.58

Jeder 0-5V-Eingang der Anzeige kann zu diesem Zweck konfiguriert werden (siehe "Konfiguration der Sensoren").

Um den gewünschten Modus einzustellen, betätigen Sie den ausgewählten Beleuchtungseingangsstift am MX150-Anschluss wie folgt:

| Zum Einstellen des Modus... | Dann...  |
|-----------------------------|--|
| Tag                         | stellen Sie den Stiftschalter auf <b>GND/OPEN</b> .      |
| Nacht                       | stellen Sie den Stiftschalter auf <b>BATTERIE PLUS</b> . |

In den Sensoreinstellungen muss die Funktion des entsprechenden Spannungseingangs als Beleuchtungseingang definiert werden.

### **PRIORITÄT VON DATENQUELLEN**

Wenn die gleichen Daten von mehr als einer Quelle für denselben Motor verfügbar sind, wird die Priorität des empfangenen Signals folgendermassen gewertet:

- Analoger Eingang
- SAE J1939
- NMEA 2000

# ERSTE SCHRITTE

## KONZEPT BEDIENUNG

Im Normalbetrieb zeigt das Display eine von bis zu zehn personalisierbaren Datenseiten an. Wischen Sie auf dem Touchscreen nach links oder rechts, um durch diese Datenseiten zu blättern.

Um das Menü des VMH 70 zu öffnen, drücken Sie auf das Feld MENU in der unteren linken Ecke des Bildschirms. Diese Taste führt zum Hauptmenü, welches die folgenden vier Untermenüs enthält:



- **System Configuration**  
Ändern Sie Systemeinstellungen wie Helligkeit, verwendete Masseinheiten oder die Uhrzeit.
- **Screen Configuration**  
Löschen Sie Datenseiten, fügen Sie neue hinzu oder personalisieren Sie die Daten, die auf den aktuellen Seiten angezeigt werden sollen.
- **Alarms**  
Sehen Sie die aktiven Alarmer und definieren Sie die Einstellungen, wann ein Alarm angezeigt, gesendet, oder der externe Buzzer ausgelöst werden soll.
- **Sensor Configuration**  
Definieren Sie alle Einstellungen für die analogen Eingänge.

Weitere Informationen zu diesen Menüs finden Sie in den entsprechenden Kapiteln in diesem Dokument.

Die Helligkeit des Displays kann jederzeit durch Drücken der Pfeiltasten auf der linken Seite des Geräts geändert werden.

## STANDBY-MODUS

Das VMH 70-Display bietet einen Standby-Modus. Dabei wird bloss der Bildschirm ausgeschaltet, um entweder den Stromverbrauch zu senken oder um in Dunkelheit die Beleuchtung abzuschalten, wenn das Gerät nicht benötigt wird.

Das Gerät ist im Standby-Modus voll funktionsfähig und kann sofort wieder eingeschaltet werden.

Um den Standby-Modus zu aktivieren, drücken Sie einfach die Taste mit dem Power-Symbol.



## EINSCHALTEN UND AUSSCHALTEN

Der Ein/Aus-Modus hängt vom Zündungssignal an Klemme 15 ab (Stecker Motor 1, Pin 7 - gelbes Kabel). Beim Einschalten erscheinen das Logo und die Softwareversion, gefolgt von einer Sicherheitswarnung und der zuletzt vor dem Ausschalten angezeigten Datenseite.



Während das VMH 70 eingeschaltet ist, kann es wie oben beschrieben, in den Standby-Modus versetzt werden.

Sie können den Ladebildschirm, der beim Aufstarten des Geräts angezeigt wird, mit dem Veratron Configuration Tool anpassen.

Wenden Sie sich für weitere Informationen an Ihren Veratron-Händler.



## FUNKTIONEN DER MENÜTASTEN

Wenn Sie das Menü bedienen, werden diese Tasten am rechten Rand des Displays angezeigt. Benutzen Sie sie, um durch das Menü zu navigieren. Es ist nicht möglich, das Menü durch Hoch- und Runterwischen der Liste zu bedienen.

| Schaltfläche  | Name      | Funktion  |
|---|-----------|---|
|  | ZURÜCK    | <ul style="list-style-type: none"> <li>Zurück zum vorherigen Menü</li> </ul>  |
|  | AUF<br>AB | <ul style="list-style-type: none"> <li>Bewegung im Menü</li> </ul>  |
|  | ENTER     | <ul style="list-style-type: none"> <li>Öffnen eines Untermenüs</li> <li>Bestätigen der aktuellen Auswahl</li> </ul> |

## TOUCH-BUTTON-FUNKTIONEN

Die folgenden Touch-Buttons sind in das Glas auf der linken Seite des Bildschirms eingearbeitet. Während die Datenbildschirme angezeigt werden, haben die Tasten die folgenden Funktionen:

| Schaltfläche  | Name      | Funktion  |
|---|-----------|---|
|  | AUF<br>AB | <ul style="list-style-type: none"> <li>Helligkeit des Bildschirms ändern</li> </ul>   |
|  | STANDBY   | <ul style="list-style-type: none"> <li>Drücken Sie diese Taste, um das Display in den Standby-Modus zu bringen oder um es aus dem Standby-Modus heraus, wieder aufzustarten. (Funktioniert nur, wenn auch das Zündsignal eingeschaltet ist).</li> </ul> |

## KALIBRIERUNGS-ASSISTENT

Der Kalibrierungsassistent erscheint beim ersten Einschalten nach einem Factory Reset und bei jedem weiteren Einschalten, bis die Sensoren kalibriert wurden.

Das Display fordert Sie auf, Ihre Sensoren zu konfigurieren.

Wählen Sie [Yes], um das Menü SENSOR CONFIG zu öffnen.

Wählen Sie [No], um die erste Standarddatenseite anzuzeigen und die Sensoren später zu konfigurieren.



## EINSTELLEN DES TAG/NACHT-MODUS

Es gibt drei Möglichkeiten, das Display in den Tag- oder Nachtmodus zu versetzen:

- **Beleuchtungseingang**  
Definieren Sie einen der 0-5-Volt-Analogeingänge als Beleuchtungseingang und schliessen Sie ihn an einen externen Schalter oder an das Beleuchtungssignal des Schiffes an. Weitere Informationen zur Installation finden Sie im Kapitel "Tag-/Nachtmodus-Wahlschalter (S1)" im Abschnitt "Elektrische Anschlüsse".
- **Lichtsensord**  
Aktivieren Sie den eingebauten Lichtsensor unter [SYSTEM CONFIGURATION] > [DISPLAY] > [Auto Day-/Night Mode], damit das Display abhängig von der Helligkeit der Umgebung automatisch zwischen Tag- und Nachtmodus umschaltet.
- **Manuell über das Menü**  
Um manuell zwischen den verschiedenen Modi zu wechseln, treffen Sie eine Auswahl im Menü [SYSTEM CONFIGURATION] > [DISPLAY] > [ILLUMINATION].

## CHECKLISTE FÜR DIE INBETRIEBNAHME

Im Folgenden werden die Schritte für die Erstkonfiguration beschrieben:

1. Schliessen Sie die Sensoren an die analogen Eingänge an.
2. Lesen Sie nach dem Einschalten die Sicherheitsmeldung und wählen Sie dann [Yes], um das Menü SENSOR CONFIGURATION zu öffnen und die Parameter der Sensoren zu definieren (siehe "Sensorkonfiguration").
3. Richten Sie die allgemeinen Gerätefunktionen ein (siehe "Systemeinstellungen").
4. Hinzufügen/Entfernen von Datenseiten durch Auswahl der passenden Layouts und der anzuzeigenden Daten (siehe "Konfiguration der Datenseiten").
5. Wenn ein Seitenlayout mit Balkendiagrammen verwendet wird, passen Sie die minimalen und maximalen Intervalle an (Balkendiagrammeinstellungen, siehe "Systemeinstellungen").
6. Aktivieren/Deaktivieren von lokalen, NMEA 2000- und J1939-Alarmen (siehe "Alarmverwaltung").

## HOCHLADEN EINES BENUTZERDEFINIERTEN SPLASH-LOGOS

Ein benutzerdefiniertes Splash-Logo kann mit dem Veratron Configuration Tool von einem PC geladen werden. Dieses Logo wird jedes Mal während des Startvorgangs angezeigt.

Weitere Informationen finden Sie im Benutzerhandbuch zum Veratron Configuration Tool oder bei Ihrem Veratron-Händler.

# DATENSEITEN

Die Datenbildschirme zeigen die von den verschiedenen Quellen empfangenen Daten an. Das Display kann bis zu 10 Datenbildschirme speichern.

Standardmässig werden fünf Bildschirme angezeigt [Dual Engine, NavDash, Quad Data, Battery Screen, Video].

Falls es aktive Alarmer gibt, wird die Alarmseite nach der letzten Datenseite angezeigt.

## BILDSCHIRME BLÄTTERN

Streichen Sie mit dem Finger horizontal über den Touchscreen, um durch die Seiten zu blättern. Unter "Konfiguration der Datenseiten" erfahren Sie mehr über das Hinzufügen, Löschen oder Bearbeiten von Seiten.

## BILDSCHIRMLAYOUTS

Jeder Bildschirm enthält einige gemeinsame Elemente, die unabhängig von der gewählten Bildschirmaufteilung immer angezeigt werden.

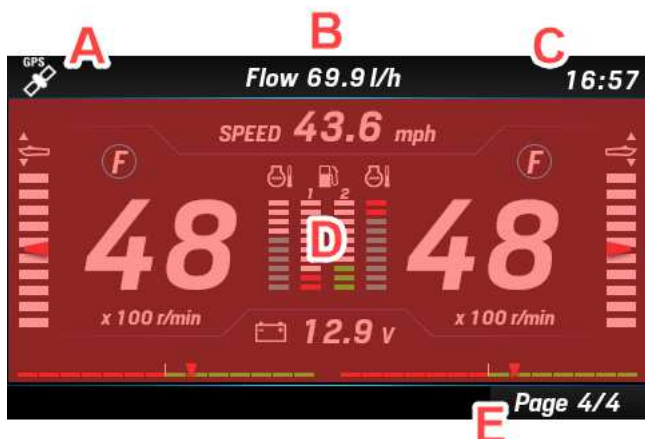

| Teil | Beschreibung                                  |
|------|---|
| A    | GPS-Signalverfügbarkeit (GPS nicht enthalten) |
| B    | Bildtitel oder zusätzliches Datenfeld (fest)  |
| C    | GPS-Zeit (falls empfangen)                    |
| D    | Inhalt des Bildschirms                        |
| E    | Seitenzahl                                    |

Der Bildschirminhalt [D] hängt von der Bildschirmkonfiguration ab, die der Benutzer für einen bestimmten Bildschirm ausgewählt hat (siehe "Bildschirmkonfiguration").

Jeder Bildschirm kann mit einem der folgenden verfügbaren Layouts angepasst werden:

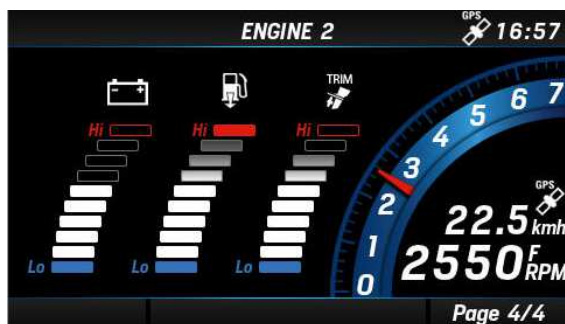

### SINGLE ENGINE-LAYOUT

Anzeige für Drehzahl, Geschwindigkeit und drei Balkendiagramme für drei ausgewählten Daten aus:

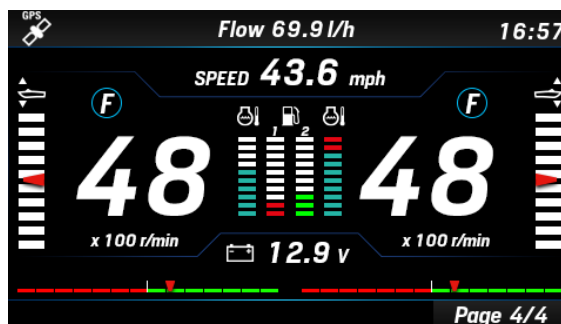

### DUAL ENGINE-LAYOUT

mit drei bestimmten Balkendiagrammen für die Daten: Trimmung, Motorkühlmitteltemperatur und Kraftstofffüllstand. Dazu werden die

Ladedruck, Trimmung, Motorkühlmitteltemperatur, Batteriespannung, Kraftstoffverbrauch.

Motordrehzahlen, die Batteriespannung, die Ruderlage, sowie die Geschwindigkeit und der eingelegte Gang angezeigt.

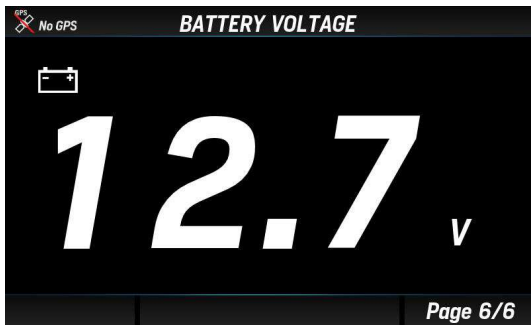

**SINGLE DATA-LAYOUT**

Einzelne Datenanzeige. Der Datenwert ist numerisch oder wird durch eine Anzeige dargestellt.



**TRIPLE DATA-LAYOUT**

Drei Felder, mit je ein oder drei Daten.

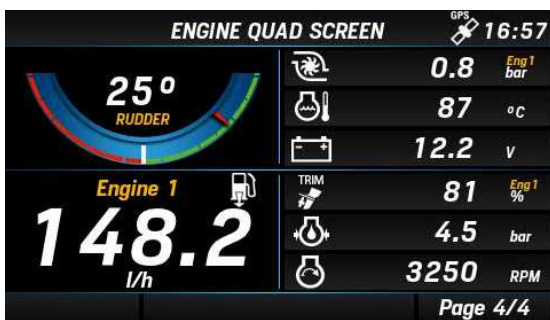

**QUAD DATA-LAYOUT**

Vier Felder, mit je ein oder drei Daten.

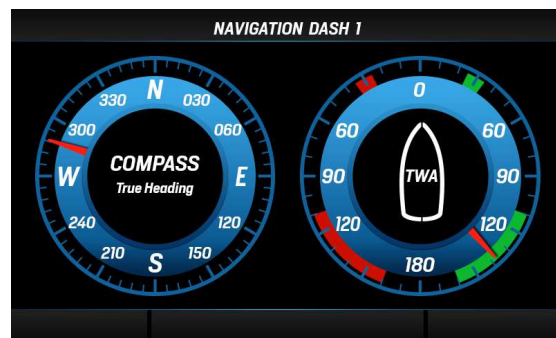

**NAV DASH-LAYOUT**

Dieses Layout ermöglicht die analoge Anzeige von Daten. Es sind drei NavDash-Layouts mit entweder zwei, drei oder acht Messgeräten auf dem Bildschirm verfügbar.

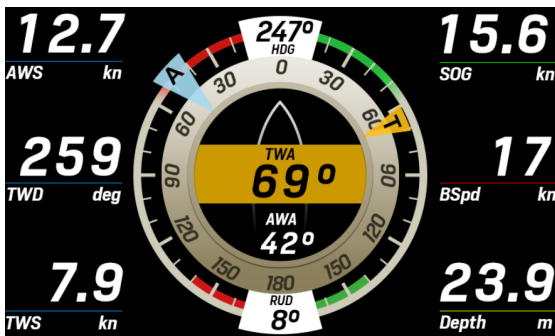

**WIND-LAYOUT**

Spezialisiertes Bildschirmlayout für die Navigation mit grafischer Darstellung der scheinbaren und reellen Winddaten.

Dafür sind sechs anpassbare Datenfelder vorgesehen.

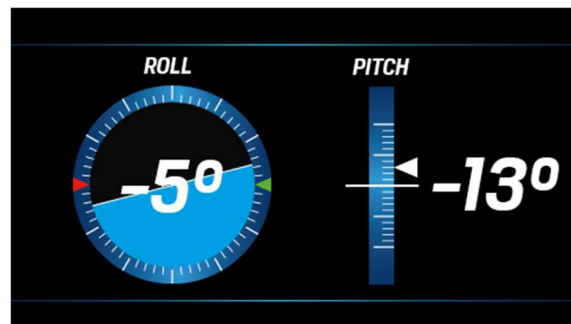

**PITCH AND ROLL LAYOUT**

Überwacht die Neigung Ihres Bootes, z.B. mit den von einem angeschlossenen NavSensor erfassten Informationen.

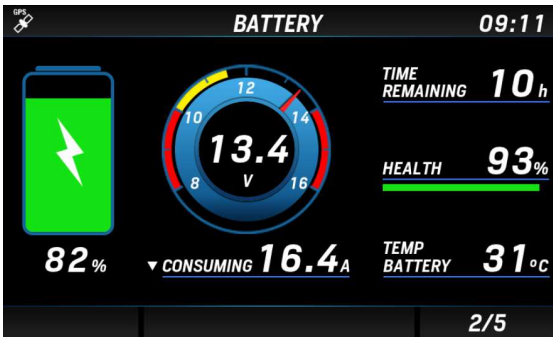

**BATTERY MONITOR LAYOUT**

Bildschirm für die Batterieüberwachung mit umfangreichen Batterieinformationen, die vom Intelligenten Batteriesensor (IBS) stammen können.

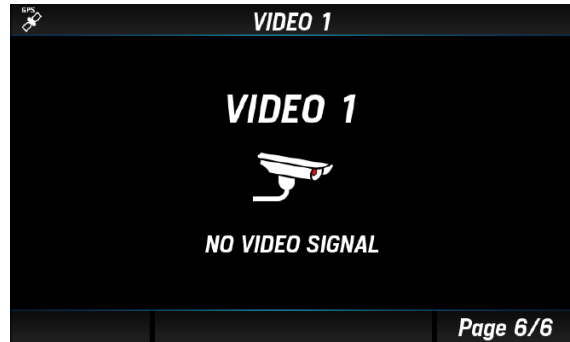











**VIDEO-BILDSCHIRM**

Zeigt das von der externen Videokamera empfangene Video an.

**UNTERSTÜTZTE DATEN**

| Icon        | Daten                           | Eingang   |           |        | Ausgang   | Einheit                |
|-------------|---------------------------------|-----------|-----------|--------|-----------|------------------------|
|             |                                 | NMEA 2000 | SAE J1939 | Analog | NMEA 2000 |                        |
|             | Motordrehzahl                   | x         | x         | x      | x         | Umdrehungen pro Minute |
|             | Trimmung                        | x         | -         | x      | x         | %                      |
|             | Ladedruck                       | x         | x         | x      | x         | bar , psi , kPa        |
|             | Kühlmitteltemperatur            | x         | x         | x      | x         | °C , °F                |
|             | Batteriespannung                | x         | x         | x      | -         | V                      |
|             | Kraftstoffverbrauch             | x         | -         | -      | -         | gal/h , L/h            |
|             | Kraftstoffdruck (127489)        | x         | x         | -      | -         | bar , psi              |
|             | Ansaugtemperatur                | -         | x         | -      | -         | °C , °F                |
| <b>LOAD</b> | Motorauslastung                 | x         | x         | -      | -         | %                      |
|             | Abgastemperatur                 | x         | x         | -      | -         | °C , °F                |
|             | Motoröltemperatur               | x         | x         | x      | x         | °C , °F                |
|             | Motoröldruck                    | x         | x         | x      | x         | bar , psi , kPa        |
|             | Getriebeöltemperatur            | x         | x         | x      | x         | °C , °F                |
|             | Getriebeöldruck                 | x         | x         | x      | x         | bar , psi , kPa        |
|             | Motorstunden                    | x         | x         | x      | x         | h                      |
|             | Ruderlage                       | x         | -         | x      | x         | °                      |
|             | Wassertiefe                     | x         | -         | -      | -         | m , ft                 |
|             | Kraftstofffüllstand (Tank: 1-4) | x         | x         | x      | x         | %                      |

| Icon   | Daten                                | Eingang   |           |        | Ausgang   | Einheit       |
|--|--------------------------------------|-----------|-----------|--------|-----------|---------------|
|  |                                      | NMEA 2000 | SAE J1939 | Analog | NMEA 2000 |               |
|         | Frischwasserstand (Tank: 1-4)        | x         | -         | x      | x         | %             |
|         | Abwasserstand (Tank: 1-4)            | x         | -         | -      | x         | %             |
|         | Wassertemperatur                     | x         | -         | -      | -         | °C, °F        |
| -  | Ausstemperatur                       | x         | -         | -      | -         | °C, °F        |
| <b>BARO</b>  | Luftdruck                            | x         | -         | -      | -         | hPa           |
|         | Kurs zu Grund (COG)                  | x         | -         | -      | -         | °             |
|         | Ausrichtung                          | x         | -         | -      | x         | °             |
| <b>AWA</b>   | Scheinbarer Windwinkel (AWA)         | x         | -         | -      | x         | °             |
|  A      | Scheinbare Windgeschwindigkeit (AWS) | x         | -         | -      | x         | km/h          |
| <b>TWA</b>   | Wahrer Windwinkel (TWA)              | x         | -         | -      | -         | km/h          |
|  T     | Wahre Windgeschwindigkeit (TWS)      | x         | -         | -      | x         | km/h          |
|       | Wahre Windrichtung (TWD)             | x         | -         | -      | x         | °             |
|       | Geschwindigkeit zu Wasser (STW)      | x         | -         | -      | -         | mph, kn, km/h |
|  A B  | Trip - Distanz                       | -         | -         | -      | -         | km, mi, nm    |
|  CA B | Trip - Reisezeit                     | -         | -         | -      | -         | h             |
|  B A  | Trip - Kraftstoffverbrauch           | -         | x         | -      | -         | L, gal        |
|       | GPS-Geschwindigkeit                  | x         | -         | -      | -         | mph, kn, km/h |
| <b>ROLL</b>  | Neigung (Roll)                       | x         | -         | -      | -         | °             |
| <b>PITCH</b>   | Neigung (Pitch)                      | x         | -         | -      | -         | °             |
| -  | Position                             | x         | -         | -      | -         | °             |
| <b>SOC</b>   | Ladestand                            | x         | -         | -      | -         | %             |
| -  | Laststrom                            | x         | -         | -      | -         | A             |
| -  | Batterie Autonomie                   | x         | -         | -      | -         | h, d          |
| <b>SOH</b>   | Gesundheitszustand der Batterie      | x         | -         | -      | -         | %             |
| -  | Batterietemperatur                   | x         | -         | -      | -         | °C, °F        |

## MOTORSTUNDEN

Wenn keine Daten aus dem NMEA-2000-Netzwerk empfangen werden, berücksichtigt das Gerät den intern gezählten Wert.

Die Zeit wird als Motorstunden gezählt, wenn die Motordrehzahl mehr als 300 RPM beträgt. Bei Vorhandensein von Daten aus dem NMEA 2000-Netzwerk berücksichtigt der Indikator die vom Netzwerk empfangenen Daten nur, wenn sie höher sind als die internen Daten.

## ZURÜCKGELEGTE ENTFERNUNG

Das Anzeigegerät berechnet intern die zurückgelegte Strecke auf der Grundlage der Geschwindigkeit und unter Berücksichtigung des unter [SENSOR CONFIGURATION] > [SPEED] eingestellten Korrekturfaktors.

## NAVDASH LAYOUT

Das NavDash-Layout ist in drei verschiedenen Konfigurationen mit zwei, drei oder acht Rundinstrumenten erhältlich.

Jedes Layout wird in einer blauen oder bernsteinfarbenen Farbpalette und je nach aktueller Display-Einstellung im Tag- oder Nachtmodus angezeigt.

Die einzelnen Ziffernblätter in diesem Layout können verschiedene Datentypen darstellen. Zur Auswahl stehen die folgenden Optionen:

- Motorumdrehungen
- Tiefe
- Ruderwinkel
- Scheinbarer Windwinkel (AWA)
- Scheinbare Windgeschwindigkeit (AWS)
- Kompass
- Geschwindigkeit durch Wasser (STW)
- Geschwindigkeit über Grund (SOG)
- Kraftstofffüllstand
- Frischwasserfüllstand
- Abwasserstand
- Trimmung
- Batteriespannung
- Motor- und Getriebeöl Druck
- Motor- und Getriebeöltemperatur
- Kühlmitteltemperatur

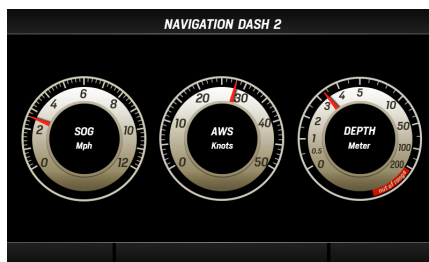
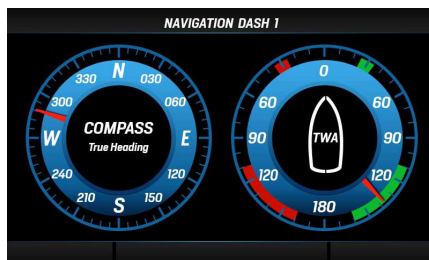

# BILDSCHIRMKONFIGURATION

Um auf die Einstellungen für die Bildschirmkonfiguration zuzugreifen, rufen Sie das Hauptmenu mit der Schaltfläche [MENU] auf, und wählen Sie [SCREEN CONFIGURATION], um die Personalisierung zu starten.



1. Rufen Sie das Hauptmenu auf, indem Sie [MENU] drücken und [SCREEN CONFIGURATION] wählen.

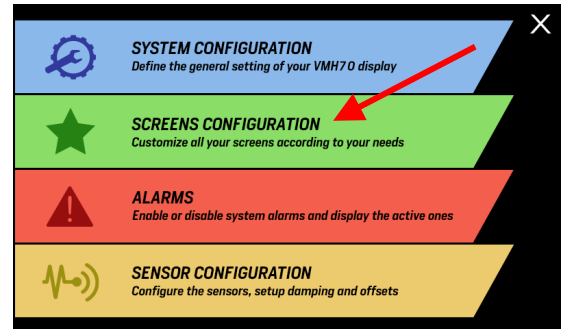

2. Blättern Sie durch die Favoritenbildschirme, bis derjenige angezeigt wird, der angepasst (oder gelöscht) werden soll, und drücken Sie zur Bestätigung [ENTER].

Um einen neuen Bildschirm am Ende der Favoriten hinzuzufügen, blättern Sie einfach, bis ein leerer Bildschirmplatz erscheint.

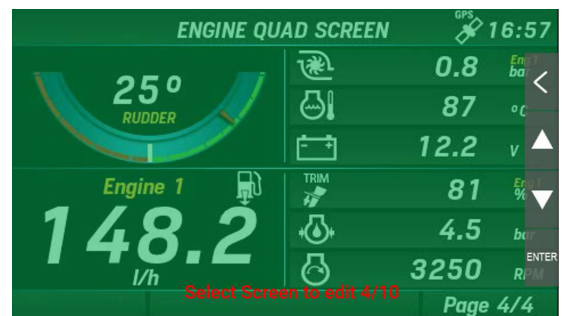

3. Wählen Sie das Bildschirmlayout für den neuen Bildschirm aus. Die möglichen Optionen sind auch im Kapitel "Bildschirmlayouts" beschrieben.

Um den ausgewählten Bildschirm zu löschen, wählen Sie [REMOVE PAGE].

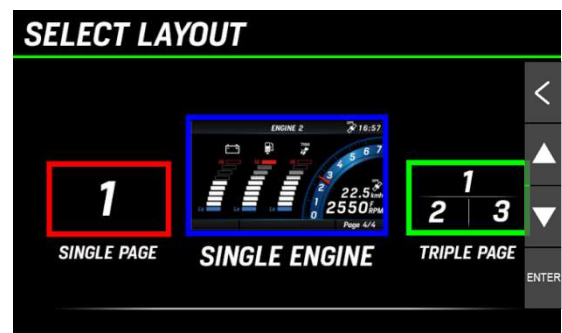

4. Je nach gewähltem Layout ist es möglich, einige Teile des Bildschirms wie Datenfelder oder Balkendiagramme individuell zu gestalten.

Das aktuell ausgewählte Element wird grün hervorgehoben.

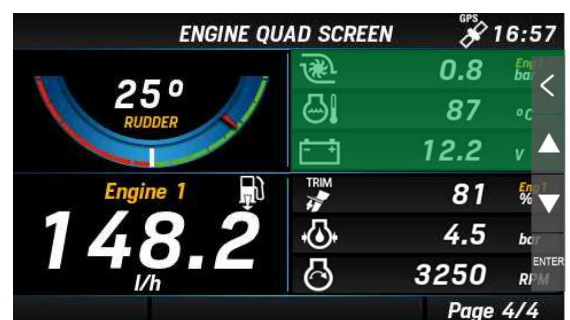

Drücken Sie ▲ oder ▼, um das nächste Feld auszuwählen.

## BILDSCHIRMKONFIGURATION

Blättern Sie durch die anpassbaren Elemente, indem Sie [AUF] und [AB] drücken.

Drücken Sie [ENTER], um das Element auszuwählen, das angepasst werden soll.

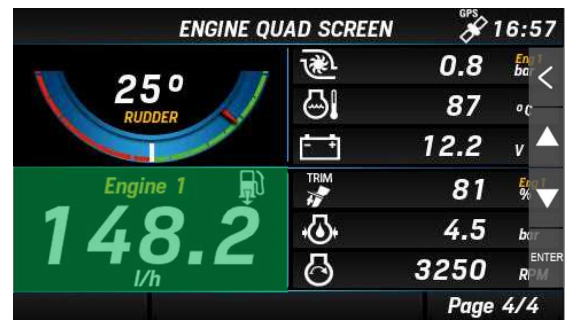

5. Sobald ein Element ausgewählt ist, wird es in roter Farbe hervorgehoben.

Drücken Sie die AUF/AB-Tasten, um die Daten zu ändern, die an dieser Stelle angezeigt werden sollen.

Im Abschnitt "Unterstützte Daten" finden Sie eine vollständige Liste der verfügbaren Daten.

Wenn die gewünschte Option gefunden wurde, drücken Sie [ENTER], um die Auswahl zu bestätigen, und das Element wird wieder grün hervorgehoben.

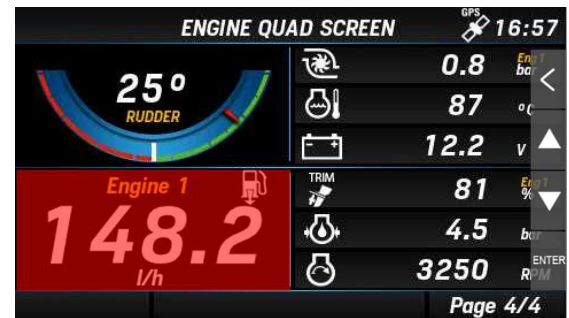

Drücken Sie ▲ oder ▼, um die Daten zu ändern.

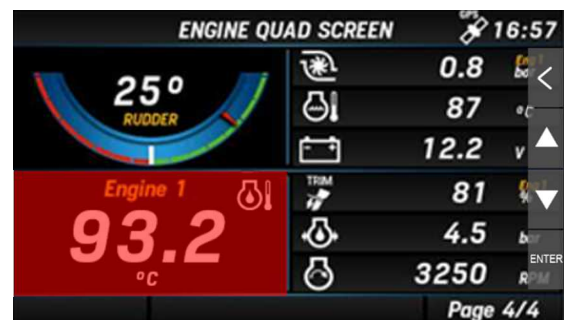

6. Um einen anderen Bildschirm einzustellen, drücken Sie mehrmals [<], bis Sie wieder zu der unter Punkt 2 beschriebenen Bildschirmauswahl gelangen.

Um die Einstellungen zu verlassen ebenfalls mehrmals auf [<] drücken.



# SYSTEMEINSTELLUNGEN

Um auf die Systemeinstellungen zuzugreifen, drücken Sie auf [MENU] und wählen Sie [SYSTEM CONFIGURATION], um die Konfiguration der Bildschirme aufzurufen.



## MENÜSTRUKTUR

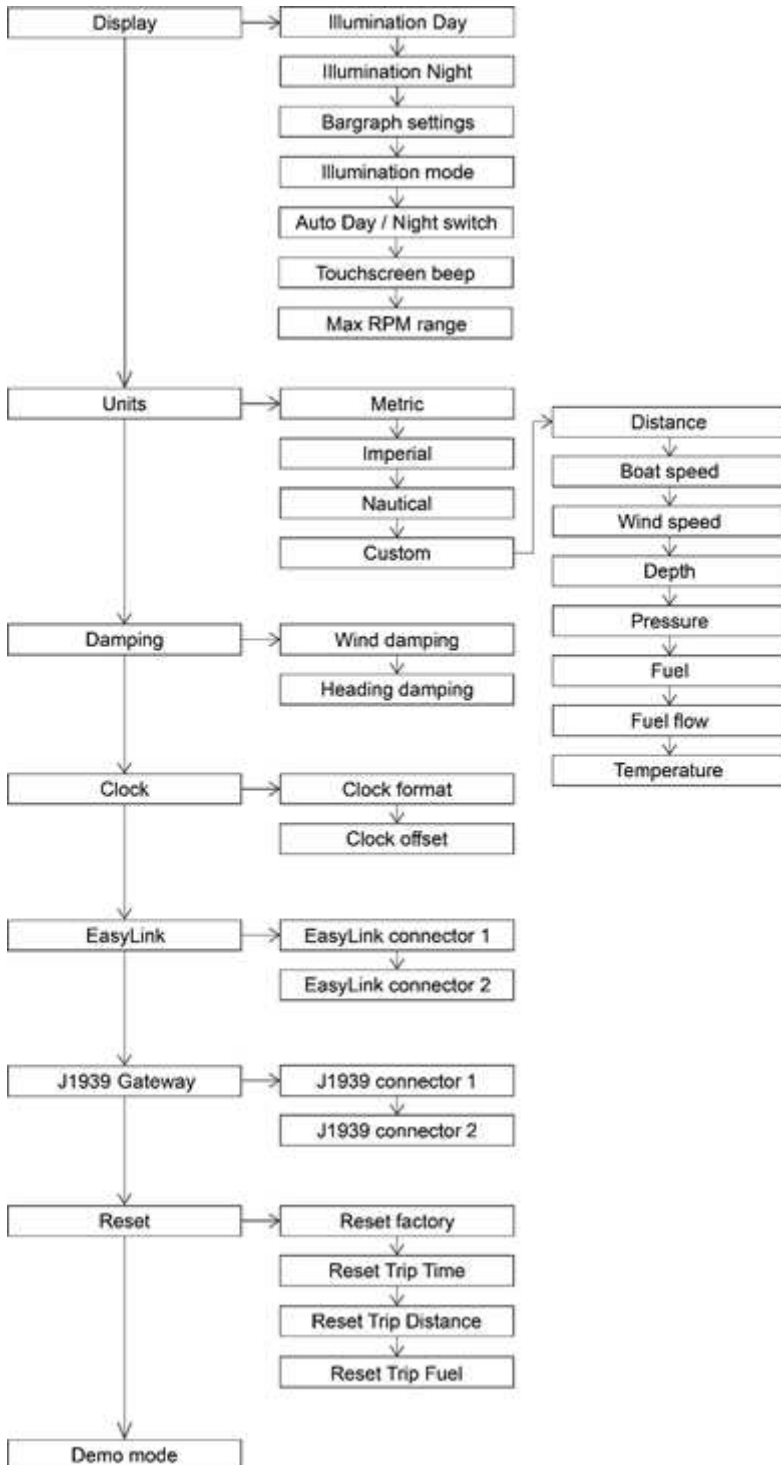

SYSTEM CONFIGURATIONS MENÜ-BEDIENUNG

HINWEIS: Der unterstrichene Wert/Befehl ist die Werkseinstellung.

| Einstellung                     | Beschreibung  | Mögliche Werte / Befehle   |
|---------------------------------|---|--|
| Display > Illumination Day      | Helligkeit des Displays für den Tagesmodus.<br><i>HINWEIS: Diese Einstellung wirkt sich auch auf alle EasyLink-Messgeräte aus.</i>  | 0-7, <u>Auto</u>   |
| Display > Illumination Night    | Helligkeit des Displays für den Nachtmodus.<br><i>HINWEIS: Diese Einstellung wirkt sich auch auf alle EasyLink-Messgeräte aus.</i>  | 0-7  |
| Display > Bargraph settings     | Einstellen der Minimal- und Maximalwerte, die auf den Balkendiagrammen darstellbar sein sollen.   | <ul style="list-style-type: none"> <li>• Ladedruck: 0-13 bar (Standard = 0-1)</li> <li>• Öldruck: 0-13 bar (Standard = 0-1)</li> <li>• Motortemperatur 0-300 °C (Standard = 0-200)</li> <li>• Batteriespannung 8-32 V (Standard = 10-16)</li> <li>• Kraftstoffdurchfluss 0-800 L/h (Standard = 0-150)</li> </ul>   |
| Display > Illumination mode     | Auswahl der Farbpalette und des Tag-/Nachtmodus.  | <ul style="list-style-type: none"> <li>• <b>Blau - Tag:</b> blaue Zifferblätter, weiße Zahlen, Beleuchtung: Z</li> <li>• <b>Blau - Nacht:</b> blaue Zifferblätter, rote Zahlen, Beleuchtung: 2</li> <li>• <b>Bernstein - Tag:</b> Bernsteinfarbene Zifferblätter, weiße Zahlen, Beleuchtung: Z</li> <li>• <b>Bernstein - Nacht:</b> Bernsteinfarbene Zifferblätter, rote Zahlen, Beleuchtung: 2</li> </ul> |
| Display > Auto Day/Night Switch | Aktivieren Sie den integrierten Lichtsensor, um automatisch zwischen Tag- und Nachtmodus zu wechseln, und legen Sie fest, bei welcher Helligkeitsstufe das Display umgeschaltet werden soll.<br><br><i>HINWEIS: Dies ist nur möglich, wenn der Beleuchtungseingang (Term. 58) in den Sensorkonfigurationen deaktiviert ist.</i> | <ul style="list-style-type: none"> <li>• <u>AUS</u></li> <li>• Hell</li> <li>• Mittel</li> <li>• Dunkel</li> </ul>   |
| Display > Touchscreen Beep      | Aktivieren oder deaktivieren Sie das akustische Feedback für die Touchscreen-Interaktionen.   | <ul style="list-style-type: none"> <li>• <u>ON</u></li> <li>• OFF</li> </ul>   |
| Display > Max RPM Range         | Wählen Sie den Messbereich für die Motordrehzahl. Die Skalen in den verschiedenen Layouts passen sich an diesen Maximalwert an.   | <ul style="list-style-type: none"> <li>• 3000, <u>4000</u>, 7000</li> </ul>  |

## SYSTEMEINSTELLUNGEN

| Einstellung   | Beschreibung  | Mögliche Werte / Befehle  |
|---|---|---|
| Units   | Masseinheit für die angezeigten Daten.  | <ul style="list-style-type: none"> <li>• <u>Metrisch</u></li> <li>• Imperial</li> <li>• Nautisch</li> <li>• Benutzerdefiniert</li> </ul>  |
| Damping ><br>Wind damping/<br>Heading damping                   | Dämpfung für Wind- und Kursdaten.   | <ul style="list-style-type: none"> <li>• Aus</li> <li>• <u>Schwach</u></li> <li>• Mittel</li> <li>• Stark</li> </ul>  |
| Clock ><br>Clock format   | Anzeigeformat der Uhr.  | <ul style="list-style-type: none"> <li>• <u>12h</u></li> <li>• 24h</li> </ul>   |
| Clock ><br>Clock offset   | Einrichtung der Zeitzone.   | Von -12h bis +12h ( <u>0h</u> )   |
| EasyLink ><br>EasyLink connector<br>1 / EasyLink<br>connector 2 | Die Daten von welchem Motor auf den VMH 14 EasyLink-Satelliten angezeigt werden sollen. Die Einstellung gilt immer für die gesamte Daisy Chain an diesem Anschluss.<br><br><i>HINWEIS: OceanLink-Satelliten werden nicht unterstützt.</i> | <ul style="list-style-type: none"> <li>• Motordaten anzeigen von: Motor 1-4</li> </ul>  |
| J1939 ><br>Connector1 /<br>Connector 2                          | Konfiguration für das SAE J1939 zu NMEA 2000 Gateway.<br><br>Alle über den J1939-Bus empfangenen Daten werden über NMEA 2000 mit der hier angegebenen Instanz gesendet.   | Senden an NMEA 2000 als: <ul style="list-style-type: none"> <li>• <u>Auto</u>: Das Display behält die J1939-Motorkennung auch für das NMEA 2000-Netzwerk bei.</li> <li>• Motor 1-4</li> </ul>             |
| Reset ><br>Reset factory  | Setzen Sie die Anzeige auf die Werkseinstellungen zurück.   | <ul style="list-style-type: none"> <li>• Ja</li> <li>• <u>Nein</u></li> </ul>   |
| Reset ><br>Reset Trip time                                      | Trip-Fahrzeit zurücksetzen  | <ul style="list-style-type: none"> <li>• Ja</li> <li>• <u>Nein</u></li> </ul>   |
| Reset ><br>Reset Trip Distance                                  | Trip-km-Zähler zurücksetzen   | <ul style="list-style-type: none"> <li>• Ja</li> <li>• <u>Nein</u></li> </ul>   |
| Reset ><br>Reset Trip Fuel                                      | Trip-Benzinverbrauch zurücksetzen   | <ul style="list-style-type: none"> <li>• Ja</li> <li>• <u>Nein</u></li> </ul>   |
| Demo mode   | Aktivierung des Demo-Modus. (Simulierte Daten werden NICHT über NMEA 2000 gesendet.)<br><br><i>Hinweis: Der Demomodus bleibt auch nach einem Neustart des Geräts aktiv.</i>   | <ul style="list-style-type: none"> <li>• Ein: Anzeigedaten werden simuliert. Die Simulation wird auch an EasyLink-Satelliten gesendet.</li> <li>• <u>Aus</u>: Der Demomodus ist ausgeschaltet.</li> </ul> |

**EINHEITEN**

| Einstellung          | Metrisch | Imperial | Nautisch | Benutzerdefiniert  |
|----------------------|----------|----------|----------|--------------------|
| Entfernungen         | km       | mi       | nm       | km, mi, nm         |
| Bootsgeschwindigkeit | km/h     | mph      | kn       | km/h, mph, kn      |
| Windgeschwindigkeit  | km/h     | kn       | kn       | km/h, kn, m/s, bft |
| Tiefe                | m        | ft       | ft       | m, ft              |
| Druck                | bar      | psi      | psi      | bar, psi, kPa      |
| Kraftstoff           | L        | gal      | gal      | L, gal             |
| Kraftstoffverbrauch  | L/h      | gph      | gph      | L/h, gph           |
| Temperaturen         | °C       | °F       | °F       | °C, °F             |

**SAE J1939-GATEWAY**

Das VMH-Display ist mit zwei individuellen SAE J1939-Anschlüssen ausgestattet, über die Sie Ihre CAN-Motoren mit dem Display verbinden und die von ihnen kommenden digitalen Daten lesen können. Stellen Sie sicher, dass das J1939-Gateway richtig eingerichtet ist, damit alle Motordaten über NMEA 2000 mit der richtigen Instanz übertragen werden.

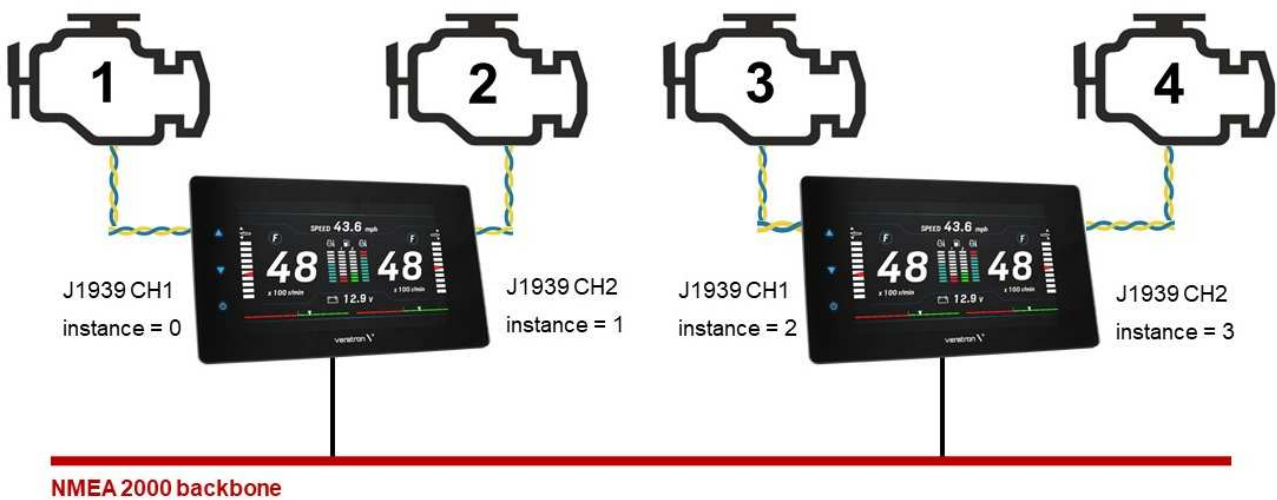

# SENSOR-KONFIGURATIONEN

Um auf die Einstellungen der Sensoren zuzugreifen, rufen Sie das Hauptmenu auf, indem Sie auf [MENU] drücken, und wählen Sie [SENSOR CONFIGURATION], um darauf zuzugreifen.



## MENÜSTRUKTUR

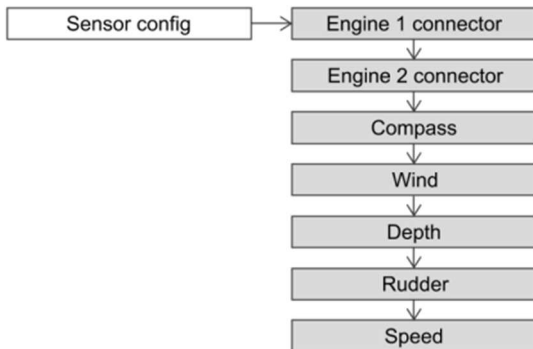

| Einstellung                     | Beschreibung   | Mögliche Werte                           |
|---------------------------------|--|--|
| Engine 1 connector              | Konfigurieren Sie die Sensoren, die über die Analogeingänge des «Motor 1-Anschlusses» mit dem Display verbunden sind (siehe "Elektrische Anschlüsse"). | -  |
| Engine 2 connector              | Konfigurieren Sie die Sensoren, die über die Analogeingänge des «Motor 2-Anschlusses» mit dem Display verbunden sind (siehe "Elektrische Anschlüsse"). | -  |
| Compass > Heading offset        | Winkelversatz zwischen dem Kompass und dem Schiff.   | $\pm Q - 180^\circ$                      |
| Compass > Variation             | Offset für magnetische Abweichung (Differenz zwischen Magnetischem und Geographischem Nordpol)   | $\pm Q - 180^\circ$                      |
| Compass > Send True Heading     | Aktivieren Sie diese Option, damit das Display den intern berechneten Wert für «True Heading» über NMEA 2000 überträgt.                                | Ja / <u>Nein</u>                         |
| Wind > Wind direction offset    | Winkelversatz zwischen der 0°-Position des Windsensors und der Längsachse des Bootes.  | $\pm Q - 180^\circ$                      |
| Wind > Send True Wind           | Aktivieren Sie diese Option, damit das Display die intern berechneten wahren Winddaten (TWA und TWS) über NMEA 2000 überträgt.                         | Ja / <u>Nein</u>                         |
| Depth                           | Einstellung eines Offsets für die Wassertiefenmessung. Positiv für Tiefe unterhalb der Wasserlinie, negativ für Tiefe unterhalb des Kiels.             | $\pm 0 - 9,9\text{ m}$<br>(default: 2 m) |
| Rudder                          | Einstellung des Ruderversatzes.  | $\pm Q - 120^\circ$                      |
| Speed > Speed correction factor | Korrektur der über NMEA 2000 empfangenen Schiffsgeschwindigkeitsdaten. Siehe "Berechnen des Geschwindigkeits-Offsets".                                 | 0 - 199.99<br>(default: 1.0)             |

KONFIGURIEREN EINES AN DAS DISPLAY ANGESCHLOSSENEN SENSORS

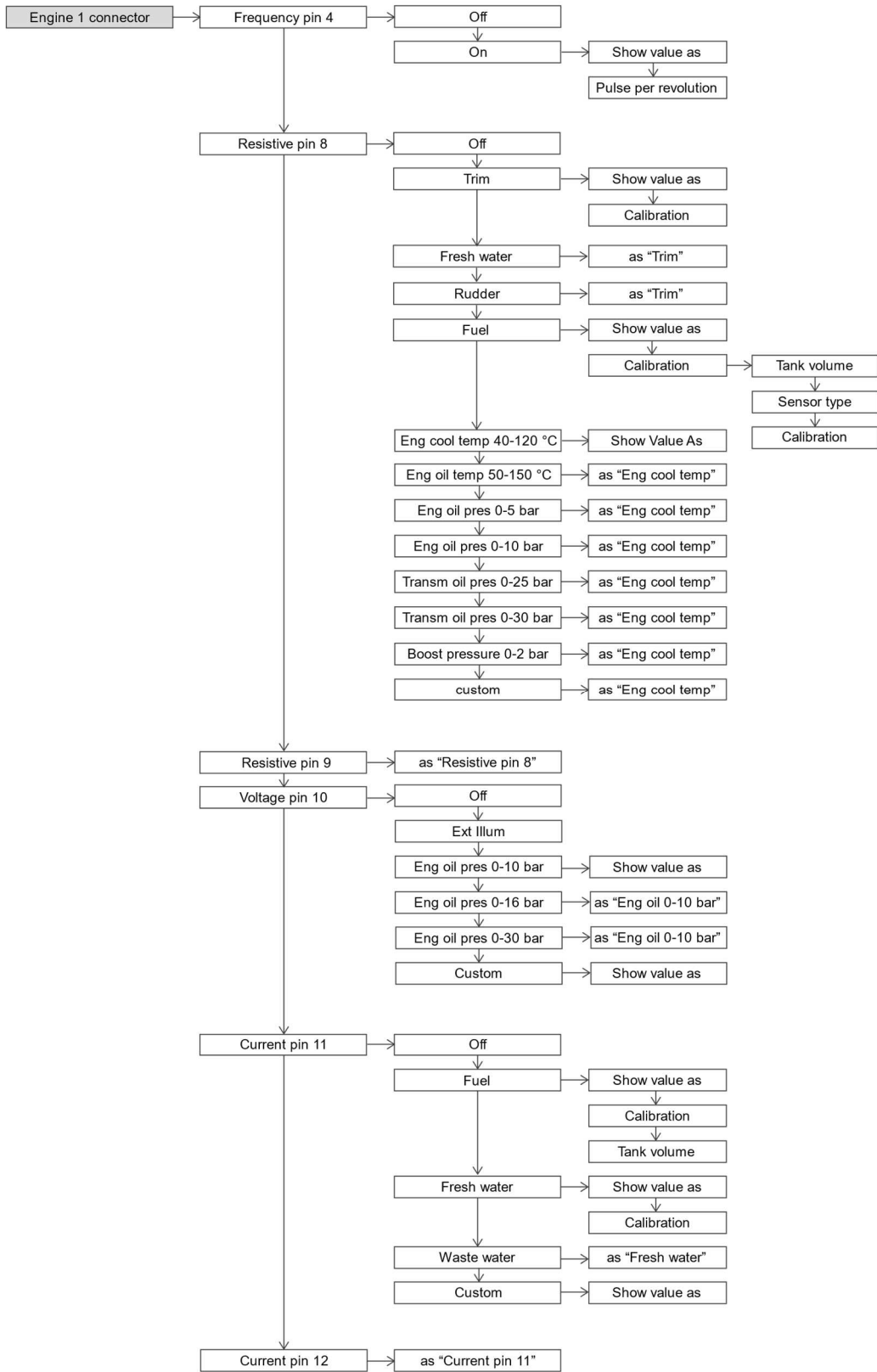

**1. AUSWAHL EINES EINGANGS**

Im Menü SENSOR CONFIGURATION wählen Sie [Engine 1 connector] oder [Engine 2 connector], je nachdem, an welchen Anschluss der Sensor verdrahtet ist.

Wählen Sie dann den passenden Analogeingang aus den Pins dieses Steckers.

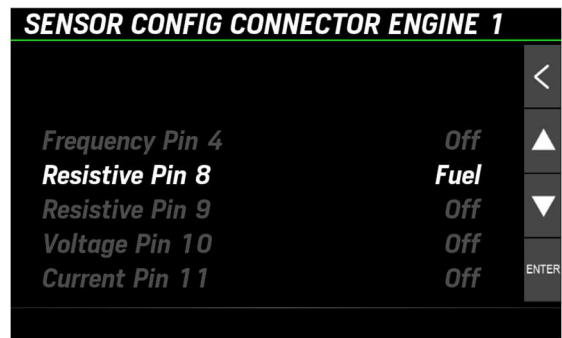

**2. WÄHLEN DES SENSORTYPS**

Wählen Sie aus, welche Art von Sensor an diesen Eingang angeschlossen ist.

Die vollständige Liste der unterstützten Sensoren für den gewählten Eingang wird im Menu dargestellt.

Wählen Sie [CUSTOM], um die komplette Eingangskonfiguration aus dem PC Veratron Configuration Tool zu importieren.

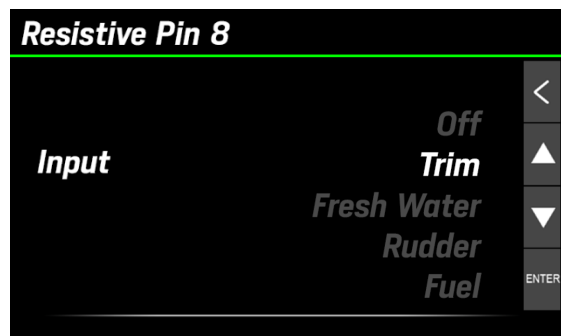

**3. DEN NMEA 2000-AUSGANG KONFIGURIEREN**

Der Messwert für den konfigurierten Analogsensor wird ebenfalls über NMEA 2000 übertragen, so dass das VMH-Display als Quelle für diese Daten dient.

Verwenden Sie den Menüpunkt "Show Value As", um die NMEA 2000-Instanz für diesen Sensor zu ändern.

Wenn bei der Einrichtung ein Konfigurationskonflikt festgestellt wird (z.B. wenn zwei Sensoren mit derselben Instanz an verschiedenen analogen Anschlüssen konfiguriert sind), wird auf dem Display eine Warnung angezeigt.

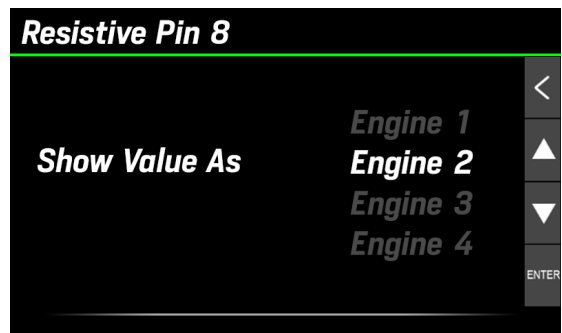

**4. DEN SENSOR KALIBRIEREN**

Für jeden Sensortyp gibt es eine Standardkalibrierung (siehe "Unterstützte Standardkalibrierungen"). Veratron-Sensoren werden standardmässig unterstützt.

Bei einigen Sensoren ist es möglich, die Sensorcurve mit Hilfe eines Assistenten zu kalibrieren (siehe nächstes Kapitel).

Jeder Sensor kann grundsätzlich über das PC-basierte Veratron Configuration Tool kalibriert werden (siehe "Sensorkalibrierung mit Veratron Configuration Tool").

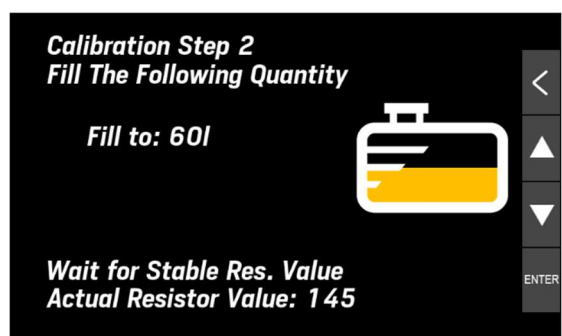

## KALIBRIERUNG DES KRAFTSTOFFSTANDSSENSORS

1. Wählen Sie im zuvor beschriebenen Eingangs-Konfigurationsmenü [Calibration], um die Kalibrierungsoptionen des Sensors zu öffnen.
2. Wählen Sie [Tank Volume], um das Fassungsvermögen des Tanks einzustellen (nicht obligatorisch).
3. Wählen Sie [Sensor Type], dann wählen Sie den Sensortyp aus den vorgeschlagenen Standardtypen.
4. Wählen Sie [Calibration] und dann das Einpunkt- oder Dreipunkt-Kalibrierverfahren (**Do 1 point cal/Do 3-point cal**). Es erscheinen Anweisungen und der in Echtzeit vom Sensor abgelesene ohmsche Wert [A].
5. Entleeren Sie den Tank und warten Sie, bis sich der abgelesene Wert stabilisiert hat. Bestätigen Sie dann mit der Taste [ENTER].
6. Für die Dreipunktkalibrierung folgen Sie den Anweisungen auf dem Bildschirm.

Kehren Sie zu den Datenseiten zurück, indem Sie mehrfach [<] drücken

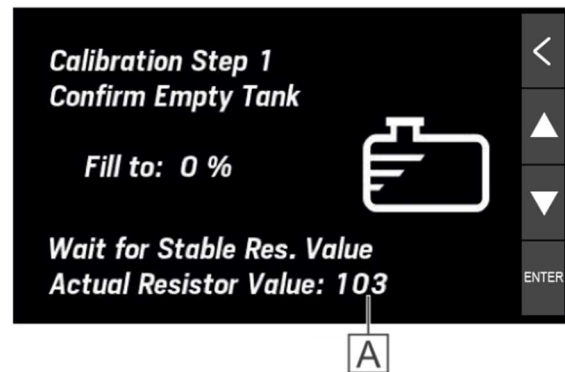
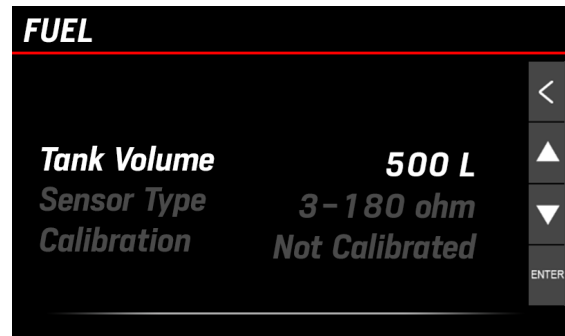

## KALIBRIERUNG ANDERER SENSOREN

1. Wählen Sie im zuvor beschriebenen Eingangs-Konfigurationsmenü die Option [Calibration], um die Kalibrierungsoptionen des Sensors zu öffnen.
2. Wählen Sie dann das Drei-Punkt-Kalibrierverfahren.
3. Es erscheinen Kalibrierungsanweisungen und der in Echtzeit vom Sensor gelesene ohmsche Wert.
4. Bei Frisch- und Abwassersensoren müssen die Tanks entleert werden; dann kurz warten, bis sich der abgelesene Wert stabilisiert hat. Bestätigen Sie den Messwert durch Drücken von [ENTER].
5. Fahren Sie mit der Kalibrierung fort, indem Sie die Anweisungen des Assistenten befolgen.
6. Kehren Sie zu den Datenseiten zurück, indem Sie mehrfach [<] drücken.

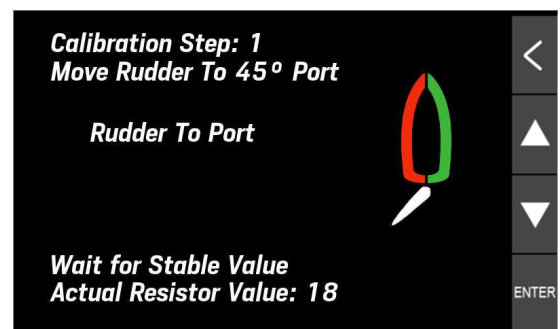
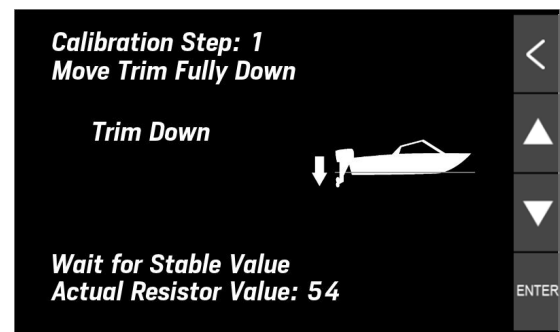



**BENUTZERDEFINIERTER SENSOR-KONFIGURATION**

Im unteren Teil der Sensorkonfigurations-Seite können Sie die Konfiguration jedes analogen Anschlusses Ihres VMH-Displays vollständig anpassen.

*HINWEIS: Für diesen Vorgang müssen Sie noch einige Einstellungen am Display selbst vornehmen (stellen Sie den Eingang auf "Custom" und wählen Sie die Dateninstanz aus).*

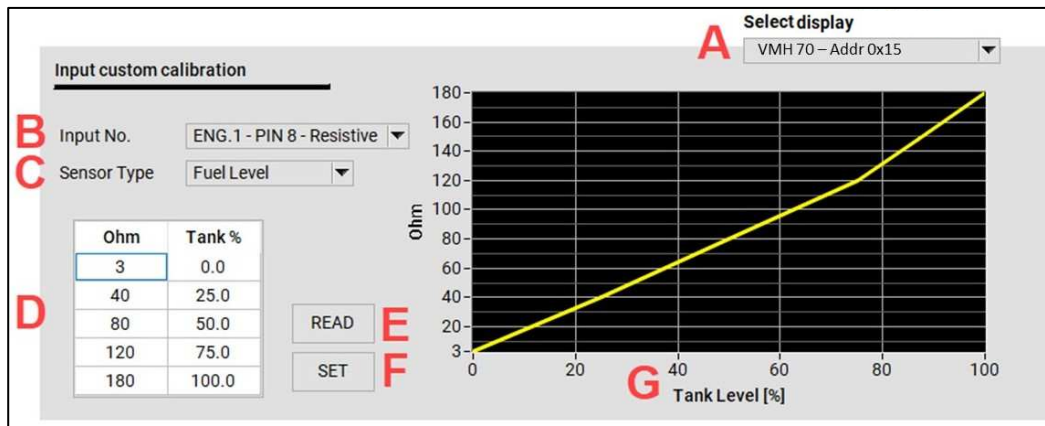

- 1 Wählen Sie das Gerät**, das angepasst werden soll, aus der Dropdown-Liste [A]. Wenn sich mehrere Geräte im Netzwerk befinden, werden sie alle in dieser Liste angezeigt.

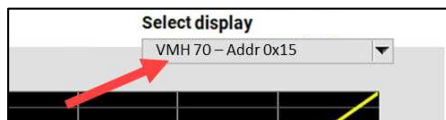

- 2 Stellen Sie in den Einstellungen auf dem Display die Pin-Konfiguration auf "CUSTOM".**  
*Sensor Configuration → Wählen Sie den zu konfigurierenden Anschluss → Sensor-Eingang → Custom*

Diese Einstellung ist für das Display erforderlich, damit die lokale Pin-Konfiguration überschrieben werden kann.  
 Wenn CUSTOM ausgewählt ist, muss die Konfiguration aus dem Tool stammen.

- 3 Wählen Sie im PC-Tool den zu konfigurierenden Eingang [B].**  
 Diese Auswahl muss mit dem Pin übereinstimmen, der im vorherigen Schritt auf dem Display als CUSTOM konfiguriert wurde.

- 4 Wählen Sie den Sensortyp** aus der Dropdown-Liste [C].

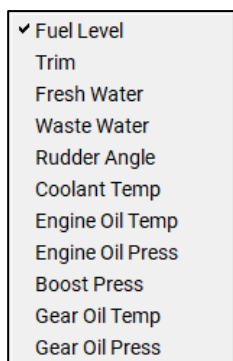

- 5 Geben Sie die 5-Punkte-Kalibrierung manuell** in die Tabelle [D] für den ausgewählten Sensor **ein**.  
Die Grafik [G] zeigt die eingestellte Kalibrierung an.

| Ohm | Tank % |
|-----|--------|
| 3   | 0.0    |
| 45  | 25.0   |
| 90  | 50.0   |
| 135 | 75.0   |
| 180 | 100.0  |

*Das obige Beispiel bezieht sich auf einen Standard-3-180-Ω-Kraftstofffüllstandssensor.*

- 6 Laden Sie die Konfiguration** auf das Display **hoch**.  
Drücken Sie die SET-Taste [F], um die Konfiguration für den jeweiligen Pin zu schreiben.  
Es erscheint ein Pop-up-Fenster als Sicherheitsbestätigung.  
  
Drücken Sie die READ-Taste [E], um die Konfiguration für den in [A] definierten Pin vom Display auszulesen.

## STANDARD-KALIBRIERUNGEN

| Sensor-Typ                 | Kalibrierung               |
|----------------------------|----------------------------|
| Kraftstoff                 | 240-33 Ω                   |
|                            | 3-180 Ω                    |
|                            | 2-90 Ω                     |
| Frischwasser               | 3-180 Ω (ohmsche Eingänge) |
|                            | 4-20mA (Strom-Eingänge)    |
| Abwasser                   | 3-180 Ω (ohmsche Eingänge) |
|                            | 4-20mA (Strom-Eingänge)    |
| Trimmung                   | 10-167 Ω                   |
| Ruder                      | 10-180 Ω                   |
| Motor Kühlmitteltemperatur | 291-22 Ω                   |
| Motoröltemperatur          | 197-11 Ω                   |
| Motoröldruck               | 10-184 Ω                   |
| Ladedruck                  | 10-184 Ω                   |

**EINSTELLEN DES GESCHWINDIGKEITSKORREKTURFAKTORS**

Mit dem Geschwindigkeitskorrekturfaktor können Sie die Geschwindigkeit zum Wasser (STW, Speed through water) an die tatsächliche Geschwindigkeit anpassen. Wenn die gemessene Geschwindigkeit um mehr als 0,5 kn von der tatsächlichen Bootsgeschwindigkeit abweicht, kann dieser Faktor angepasst werden.

Eine Erhöhung des Offset-Faktors reduziert die angezeigte Geschwindigkeit (STW).

# ALARME

Das VMH-Display kann aktive Alarmer anzeigen, die entweder von NMEA 2000, SAE J1939 oder von den angeschlossenen analogen Sensoren stammen. Motoralarmer betreffen alle Motoren im Netz.



## MENÜSTRUKTUR

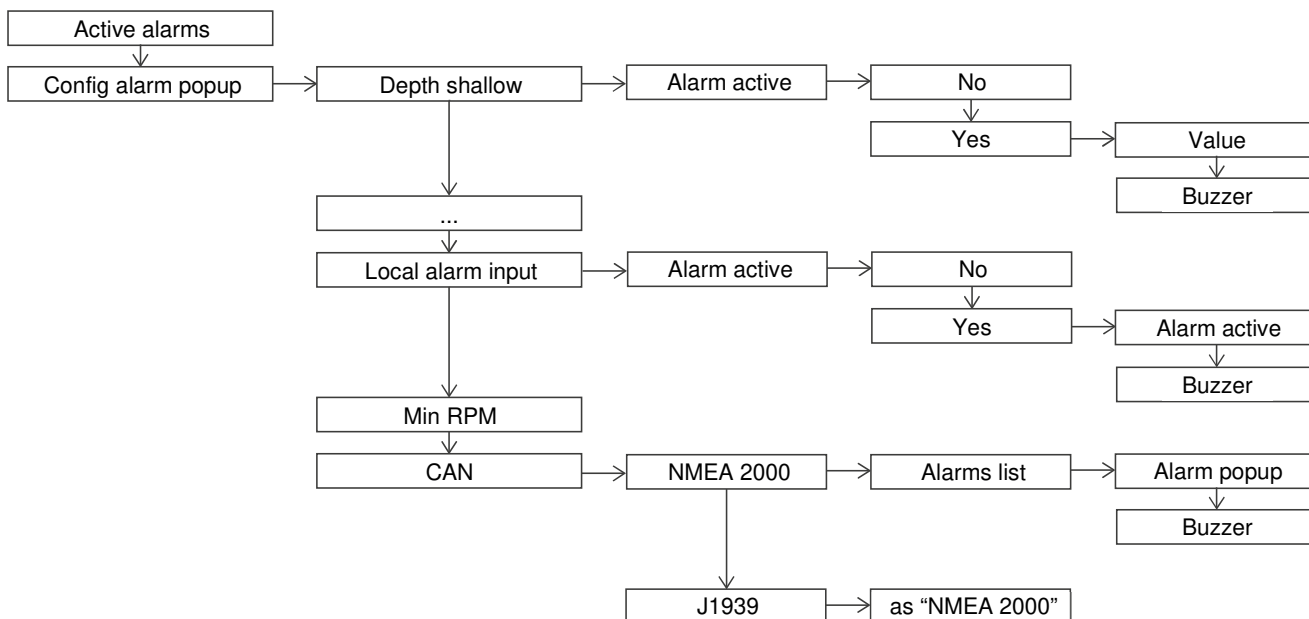

## ALARME BENACHRICHTIGUNG

Im Falle eines Alarms wird auf dem Display Folgendes angezeigt:

- Das Alarm-Pop-up erscheint
- Der Buzzer/Warnleuchte wird aktiviert (falls angeschlossen und entsprechend konfiguriert).
- Der aktive Alarm, einschliesslich zusätzlicher Informationen, wird auf dem Bildschirm «Active Alarms» angezeigt
- Falls unterstützt, wird der lokale Alarm an das NMEA 2000-Netzwerk übertragen



## EINEN ALARM QUITTIEREN

Wenn ein Alarm ausgelöst wird, erscheint das Pop-up-Fenster für die Alarmbenachrichtigung und der Buzzer ertönt (falls angeschlossen und konfiguriert).





Um den Alarm zu bestätigen und den Buzzer stumm zu schalten, drücken Sie auf den Touchscreen: Die Pop-up-Benachrichtigung wird geschlossen und der Alarm wird auf dem Bildschirm «Active Alarms» gespeichert.

Der Alarm wird so lange im Bildschirm «Active Alarms» angezeigt, wie er aktiv ist. Ein Warnsymbol am unteren Rand des Bildschirms erinnert Sie daran, dass es einen akuten Alarm gibt.

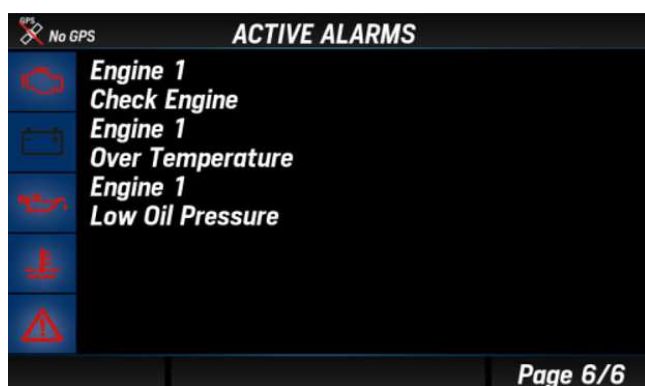
## AKTIVE ALARME

Wenn mindestens ein Alarm aktiv ist, wird nach dem letzten Bildschirm ein Bildschirm «Active Alarms» angezeigt. Derselbe Bildschirm kann über [ALARMS] > [Active Alarms] aufgerufen werden. Hier werden alle derzeit aktiven Alarmer aufgelistet, zusammen mit den Warnsymbolen.



| Symbol  | Beschreibung           |
|---|------------------------|
|  | Motor-Alarmer          |
|  | Batterie-Alarmer       |
|  | Ölalarmer              |
|  | Motortemperaturalarmer |
|  | Allgemeiner Alarm      |

## EINEN LOKALEN ALARM KONFIGURIEREN

1. Drücken Sie die MENU-Taste und wählen Sie [ALARMS] > [Setup].
2. Wählen Sie einen der unterstützten Alarmer aus
3. Aktivieren Sie ihn, indem Sie [Active] > [YES] wählen; die Alarmparameter werden angezeigt
4. Wählen und bearbeiten Sie dann den/die Schwellenwert(e) und aktivieren/deaktivieren Sie den Buzzer

| Einstellung         | Beschreibung  | Mögliche Werte              | NMEA 2000-Ausgang |
|---------------------|---|-----------------------------|-------------------|
| Depth shallow       | Alarm für seichtes Wasser.  | 0 - 9,9 m (2m)              | Nein              |
| Depth navigation    | Tiefwasseralarm (z. B. ein Wert nahe dem vom Sensor messbaren Höchstwert) und Mindestschwelle für die Sicherheitstiefe.   | 0 - 99,9 m<br>(50m, 5m)     | Nein              |
| Wind                | Hohe Windgeschwindigkeit.   | 0 - 99,9 km/h<br>(39,9km/h) | Nein              |
| Battery voltage     | Niedrige Batteriespannung.  | 0 - 32,9 V (10,8 V)         | Ja                |
| Battery Temperature | Hohe Batterietemperatur.  | 0 - 99 °C (50°C)            | Nein              |
| Battery Charge      | Niedriger Ladezustand der Batterie.   | 0 - 99 % (50%)              | Nein              |
| Engine water temp   | Kühlmittel des Motors zu hoch.  | 0 - 139 °C (110°C)          | Ja                |
| Engine oil temp     | Hohe Motoröltemperatur.   | 0 - 149 °C (120°C)          | Ja                |
| Engine oil pressure | Niedriger Motoröldruck.   | 0 - 9,9 bar (0,5bar)        | Ja                |
| Exhaust Gas Temp    | Hohe Temperatur des Abgases.  | 0 - 899 °C<br>(500°C)       | Ja                |
| Fuel                | Niedriger Kraftstofffüllstand.  | 0 - 99 % (20%)              | Nein              |
| Fresh water         | Niedriger Frischwasserfüllstand.  | 0 - 99 % (20%)              | Nein              |
| Waste water         | Hoher Abwasserstand.  | 0 - 99 % (80%)              | Nein              |
| Local alarm input   | <p>Externer digitaler Schalter (Low-Aktiver Alarm).<br/>Siehe "Elektrische Anschlüsse".</p> <p>Der Name des ausgelösten Alarms kann im Veratron Configuration Tool konfiguriert werden.<br/>Wenden Sie sich für weitere Informationen an Ihren Händler.</p> | -                           | Nein              |
| Min RPM             | Motorbezogene Alarmer werden nur ausgelöst, wenn die Motordrehzahl diesen Schwellwert überschreitet.  | 0 - 990 RPM<br>(300RPM)     | -                 |

## KONFIGURIEREN EINES CAN-ALARMS

1. Drücken Sie die MENU-Taste und wählen Sie [ALARMS] > [Setup].
2. Wählen Sie [CAN] und dann die Option [NMEA 2000] oder [SAE J1939].
3. Wählen Sie den Alarm, der aktiviert werden soll, und wählen Sie [Active] > [Yes]; die Alarmparameter werden angezeigt
4. Falls erforderlich, aktivieren/deaktivieren Sie den Buzzer

| <b>NMEA 2000-Alarme</b><br>Motor (PGN 127489)   | <b>NMEA 2000-Alarme</b><br>Übertragung (PGN 127493)  | <b>SAE J1939-Alarme</b><br>(DM1)  |
|---|--|---|
| Check engine<br>Over temperature<br>Low oil pressure<br>Low oil level<br>Low fuel pressure<br>Low system voltage<br>Low coolant level<br>Water flow<br>Water in fuel<br>Charge indicator<br>Preheat indicator<br>High boost pressure<br>Rev limit exceeded<br>EGR system<br>Throttle position sensor<br>Engine emergency stop<br>Warning level 1<br>Warning level 2<br>Power reduction<br>Maintenance needed<br>Eng com error<br>Sub or secondary throttle<br>Neutral start protect<br>Engine shutting down | Check transmission<br>Transm. over temp<br>Transm. low oil pressure<br>Transm. low oil level<br>Transm. sail drive | Engine speed<br>Boost pressure<br>Exhaust gas temperature<br>Engine oil pressure<br>Engine coolant pressure<br>Engine coolant temp<br>Engine oil temp<br>Transmission oil press<br>Transmission oil temp<br>Fuel Level<br>Water in fuel |

# FEHLERSUCHE

| Problem  | Grundlegende Ursache   | Lösung  |
|--|--|---|
| Die angezeigten Werte sind nicht wie erwartet.   | Falsche Sensorkonfiguration.   | Überprüfen Sie die Konfiguration im Menü Sensoren.  |
|  | Sensor falsch angeschlossen.   | Überprüfen Sie den Anschluss, siehe Installationsanleitung.   |
|  | Der NMEA 2000-Backbone ist nicht korrekt erstellt worden.  | Überprüfen Sie die Verbindungen und dass sowohl am Anfang als auch am Ende des Backbones ein Abschlusswiderstand vorhanden ist. |
| "- - -" wird für bestimmte Daten angezeigt oder der Zeiger blinkt im NavDash-Layout.   | Die Daten sind im Netz nicht verfügbar.  | Überprüfen Sie, ob das Gerät, das diese Informationen sendet, korrekt funktioniert.   |
|  | Sensor nicht angeschlossen.  | Schliessen Sie den Sensor an, siehe die Installationsanleitung.   |
|  | Der NMEA 2000 Netzwerk-Backbone ist nicht korrekt erstellt worden.                               | Überprüfen Sie die Anschlüsse und ob am Anfang und am Ende des Backbones ein Abschlusswiderstand vorhanden ist.                 |
| Die gleichen Daten werden mit zwei verschiedenen, sich abwechselnden Werten angezeigt. | Falsche Sensorkonfiguration. Zwei verschiedene Quellen senden die gleichen Daten über NMEA 2000. | Überprüfen Sie die Motor-/Tank-IDs («Show Value As») in den Sensoreinstellungen.  |



# TECHNISCHE DATEN

## ALLGEMEINES

|                                     |  |
|-------------------------------------|--|
| <b>Material</b>                     | Aluminium-Gehäuse<br>PC-FR Rückwand<br>Frontscheibe aus Mineralglas  |
| <b>Anzeige</b>                      | IPS TFT 7" - 800x480 - Transmissiver Touchscreen<br>Volle 24 Bit / 16 Mio. Farben  |
| <b>Steckverbinder</b>               | <ul style="list-style-type: none"> <li>• 2x Molex MX150 12-polig</li> <li>• 1x NMEA 2000 Micro-C M12 5-polig</li> <li>• 2x AMP SuperSeal 1.5 Serie (EasyLink)</li> <li>• 1x M12 4 Pin "D" Kodierung (Video)</li> </ul>   |
| <b>Eingabedaten</b>                 | <ul style="list-style-type: none"> <li>• CAN (NMEA 2000 und SAE J1939)</li> <li>• 6x ohmsche Eingänge (0-400 <math>\Omega</math>)</li> <li>• 2x kapazitive Eingänge (4-20mA)</li> <li>• 2x Frequenzeingänge (0-4 kHz)</li> <li>• 3x Spannungseingänge (0-5V)</li> <li>• 1x digitaler Alarmeingang</li> </ul> |
| <b>Daten ausgeben</b>               | <ul style="list-style-type: none"> <li>• NMEA 2000</li> <li>• 2x EasyLink</li> <li>• 2x Alarmausgänge (500mA max)</li> </ul>   |
| <b>Schutzart (gemäss IEC 60529)</b> | IPX7   |

## UMWELT

|                           |                    |
|---------------------------|--------------------|
| <b>Betriebstemperatur</b> | Von -25 bis +70 °C |
| <b>Lagertemperatur</b>    | Von -40 bis +85 °C |

## ELEKTRISCHES

|                         |   |
|-------------------------|---|
| <b>Nennspannung</b>     | 12/24 V   |
| <b>Betriebsspannung</b> | 9-32 V  |
| <b>Stromverbrauch</b>   | < 900 mA @ 12 V (nur Anzeige)<br>100mA für jedes EasyLink-Satellitenmessgerät |
| <b>Absorption (LEN)</b> | 2   |

**KONFORMITÄT**

|                                    |  |
|------------------------------------|--|
| <b>Einhaltung der Vorschriften</b> | CE, UKCA, Reach, RoHS, UL94  |
| <b>Richtlinien</b>                 | 2014/30/EU (Elektromagnetische Verträglichkeit)<br>2011/65/EU (Gefährliche Stoffe in Elektro- und Elektronikgeräten) |
| <b>Referenznormen</b>              | IEC 60945:2002-08 (Umweltklasse: ausgesetzt)   |

**UNTERSTÜTZTE NMEA 2000-NACHRICHTEN**

| Beschreibung                                | PGN    | Beschreibung                            | PGN                |
|---|--------|---|--------------------|
| J1939 Generator Average Basic AC Quantities | 65030  | Water depth                             | 128267             |
| J1939 Diagnostic Message #1                 | 65226  | Position: Rapid update                  | 129025             |
| J1939 Diagnostic Message #2                 | 65227  | COG and SOG: Rapid update               | 129026             |
| J1939 Diagnostic Message #3                 | 65228  | GNSS position data                      | 129029             |
| J1939 Diagnostic Message #4                 | 65229  | Local Time Offset                       | 129033             |
| J1939 Diagnostic Message #5                 | 65230  | Datum                                   | 129044             |
| J1939 Diagnostic Message #6                 | 65231  | Cross track error                       | 129283             |
| J1939 Diagnostic Message #8                 | 65232  | Navigation data                         | 129284             |
| J1939 Diagnostic Message #10                | 65234  | Navigation route and waypoint info      | 129285             |
| J1939 Diagnostic Message #11                | 65235  | GNSS dilution of precision (DOP)        | 129539             |
| J1939 Diagnostic Message #12                | 65236  | GNSS satellites in view                 | 129540             |
| System time                                 | 126992 | Wind data                               | 130306             |
| Rudder                                      | 127245 | Environmental parameters                | 130310             |
| Vessel heading                              | 127250 | Environmental parameters                | 130311             |
| Rate of Turn                                | 127251 | Temperature                             | 130316<br>(130312) |
| Attitude                                    | 127257 | Humidity                                | 130313             |
| Temperature (Old Version)                   | 127258 | Actual Pressure                         | 130314             |
| Engine Parameters, Rapid Update             | 127488 | Entertainment - Current File and Status | 130569             |
| Engine Parameters, Dynamic                  | 127489 | Entertainment - Data File               | 130570             |
| Transmission Parameters, Dynamic            | 127493 | Entertainment - Data Group              | 130571             |
| Engine Parameters, Static                   | 127498 | Entertainment - Data Search             | 130572             |
| Fluid level                                 | 127505 | Entertainment - Supported Source Data   | 130573             |
| DC Detailed Status                          | 127506 | Entertainment - Supported Zone Data     | 130574             |
| Battery status                              | 127508 | Small Craft Status                      | 130576             |
| Speed: Water referenced                     | 128259 |   |                    |

**ENTSORGUNGSVERANTWORTUNG**



Durch getrennte Sammlung über staatliche oder kommunale Sammelstellen entsorgen. Eine ordnungsgemäße Entsorgung und Wiederverwertung trägt dazu bei, potenziell negative Folgen für die Umwelt und die Menschen zu vermeiden.

# ERSATZTEILE UND ZUBEHÖR

## ERSATZTEILE

| Produkt                         | Teil Nummer   |
|---------------------------------|---------------|
| Strom- und Datenkabel - Motor 1 | A2C1507870001 |
| Datenkabel - Motor 2            | A2C1992110001 |
| EasyLink-Verlängerungskabel     | A2C59500139   |
| Video-Eingangskabel 0,3 m       | A2C1845710001 |
| Sonnenschutz                    | B00134401     |
| Montage-Kit                     | B00067201     |

## ZUBEHÖR

| Produkt                                 | Teil Nummer   |
|---|---------------|
| VMH 14                                  | B00109901     |
| NMEA 2000 Stromkabel                    | A2C3931290001 |
| NMEA 2000 T-Verteiler                   | A2C3931270002 |
| NMEA 2000 Verbindungskabel - 0,5m       | A2C9624370001 |
| NMEA 2000 Verbindungskabel - 2m         | A2C9624380001 |
| NMEA 2000 Verbindungskabel - 6m         | A2C9624400001 |
| NMEA 2000 Abschlusswiderstand - Stecker | A2C3931100001 |
| NMEA 2000 Abschlusswiderstand - Buchse  | A2C3931060001 |

Alle verfügbaren Zubehörteile finden Sie unter [www.Veratron.com](http://www.Veratron.com).



**Veratron AG**  
Industriestrasse 18  
9464 Rüthi, Schweiz

T +41 71 7679 111  
info@Veratron.com  
Veratron.de

---

Jegliche Verbreitung, Übersetzung oder Vervielfältigung dieses Dokuments, ganz oder teilweise, ist ohne vorherige schriftliche Genehmigung der Veratron AG strengstens untersagt, es sei denn, dies ist im Folgenden vermerkt:

- Drucken Sie das Dokument ganz oder teilweise in seinem ursprünglichen Format.
- Unveränderte Übernahme der Inhalte und Erklärung der Veratron AG als Urheberrechtsinhaberin.

Die Veratron AG behält sich das Recht vor, ohne vorherige Ankündigung Änderungen oder Verbesserungen an dieser Dokumentation vorzunehmen.

Anfragen für Genehmigungen, zusätzliche Exemplare dieses Handbuchs oder technische Informationen zu diesem Handbuch sollten an die Veratron AG gerichtet werden.

# DISPLAY MULTIFUNZIONE VMH 70

MANUALE UTENTE  
rev. AD

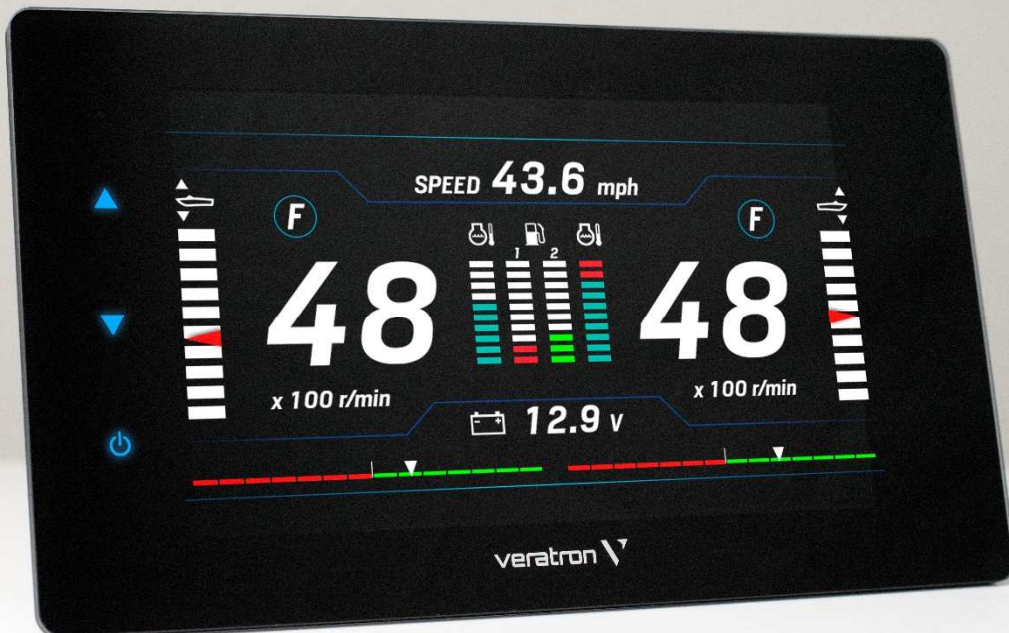

EN

DE

IT

FR

ES

# INDICE

|   |           |   |                        |
|---|-----------|---|------------------------|
| <b>INTRODUZIONE .....</b>                   | <b>3</b>  |   |                        |
| Architettura.....                           | 3         |   |                        |
| <b>INDICAZIONI PER LA SICUREZZA.....</b>    | <b>4</b>  |   |                        |
| Sicurezza durante il montaggio.....         | 4         |   |                        |
| Sicurezza dopo il montaggio.....            | 5         |   |                        |
| Collegamento elettrico.....                 | 5         |   |                        |
| <b>INSTALLAZIONE.....</b>                   | <b>7</b>  |   |                        |
| Prima del montaggio.....                    | 7         |   |                        |
| Montaggio a pannello.....                   | 8         |   |                        |
| <b>COLLEGAMENTI ELETTRICI.....</b>          | <b>10</b> |   |                        |
| Connettore Engine 1 [A].....                | 10        |   |                        |
| Connettore Engine 2 [B].....                | 11        |   |                        |
| Connettori EasyLink [C].....                | 11        |   |                        |
| Connettore NMEA 2000® [D].....              | 12        |   |                        |
| Connettore video [E].....                   | 12        |   |                        |
| Schema elettrico.....                       | 13        |   |                        |
| Collegamento del contagiri.....             | 14        |   |                        |
| Collegamento dei sensori resistivi.....     | 15        |   |                        |
| Collegamento dell'allarme esterno (B1)..... | 15        |   |                        |
| Selettore modalità giorno/notte (S1).....   | 15        |   |                        |
| Priorità dei segnali ricevuti.....          | 16        |   |                        |
| <b>PER INIZIARE .....</b>                   | <b>17</b> |   |                        |
| Funzionamento.....                          | 17        |   |                        |
| Modalità standby.....                       | 17        |   |                        |
| Accensione e spegnimento.....               | 17        |   |                        |
| Funzioni dei pulsanti del menu.....         | 18        |   |                        |
| Funzioni dei pulsanti touch.....            | 18        |   |                        |
| Procedura guidata di calibrazione.....      | 18        |   |                        |
| Impostare la modalità Giorno/Notte.....     | 19        |   |                        |
| Lista di controllo per l'avvio.....         | 19        |   |                        |
| Caricare un logo personalizzato.....        | 19        |   |                        |
| <b>PAGINE DATI .....</b>                    | <b>20</b> |   |                        |
| Scorrimento delle schermate.....            | 20        |   |                        |
| Layout delle pagine dati.....               | 20        |   |                        |
| Dati supportati.....                        | 22        |   |                        |
| Ore motore.....                             | 23        |   |                        |
| Distanza percorsa.....                      | 23        |   |                        |
|   |           |   | Layout NavDash..... 24 |
|   |           | <b>CONFIGURAZIONE DELLE PAGINE DATI ..</b>                  | <b>25</b>              |
|   |           | <b>CONFIGURAZIONE DEL DISPLAY .....</b>                     | <b>27</b>              |
|   |           | Struttura del menu.....                                     | 27                     |
|   |           | Utilizzo del menu system configuration.....                 | 28                     |
|   |           | Unità di misura.....  | 30                     |
|   |           | Gateway SAE J1939.....                                      | 30                     |
|   |           | <b>CONFIGURAZIONE DEI SENSORI.....</b>                      | <b>31</b>              |
|   |           | Struttura del menu.....                                     | 31                     |
|   |           | Configurazione di un sensore collegato al display.....      | 32                     |
|   |           | Calibrazione del sensore di livello carburante.....         | 34                     |
|   |           | Calibrazione di altri sensori (trim / angolo di barra)..... | 34                     |
|   |           | Configurazione dei sensori tramite configuration tool.....  | 35                     |
|   |           | Calibrazioni predefinite.....                               | 36                     |
|   |           | Regolazione del fattore di correzione della velocità.....   | 37                     |
|   |           | <b>ALLARMI.....</b>   | <b>38</b>              |
|   |           | Struttura del menu.....                                     | 38                     |
|   |           | Notifica degli allarmi.....                                 | 38                     |
|   |           | Riconoscere un allarme.....                                 | 39                     |
|   |           | Allarmi attivi.....   | 39                     |
|   |           | Configurazione di un allarme locale.....                    | 40                     |
|   |           | Configurazione di un allarme CAN.....                       | 41                     |
|   |           | <b>RISOLUZIONE DEI PROBLEMI .....</b>                       | <b>42</b>              |
|   |           | <b>DATI TECNICI .....</b>                                   | <b>43</b>              |
|   |           | Caratteristiche generali.....                               | 43                     |
|   |           | Caratteristiche ambientali.....                             | 43                     |
|   |           | Caratteristiche elettriche.....                             | 43                     |
|   |           | Conformità.....   | 44                     |
|   |           | Messaggi NMEA 2000 supportati.....                          | 44                     |
|   |           | Responsabilità dello smaltimento.....                       | 44                     |
|   |           | <b>RICAMBI E ACCESSORI .....</b>                            | <b>45</b>              |

# INTRODUZIONE

Il VMH 70 è un display multifunzionale progettato per il controllo motori e la navigazione. È possibile monitorare fino a quattro motori con un unico display.

Il gateway NMEA 2000 integrato consente di acquisire i dati del motore anche tramite sensori analogici o SAE J1939, per poi convertirli e distribuirli sulla rete NMEA 2000.

Il display gestisce fino a sei sensori resistivi, tre sensori in tensione (0-5V) e un ingresso di allarme digitale.

Tutti i dati sono inoltre distribuiti su due canali EasyLink fino a un massimo di 16 indicatori satellite VMH 14 per canale.

La connettività NMEA 2000 consente di visualizzare i dati di navigazione ricevuti da altri dispositivi collegati alla rete, come ad esempio vento, bussola, GPS, velocità e profondità.



## ARCHITETTURA

Di seguito è riportato un esempio di applicazione con un display VMH 70, in una configurazione mista in cui i dati provengono sia come sensori analogici che da NMEA 2000.

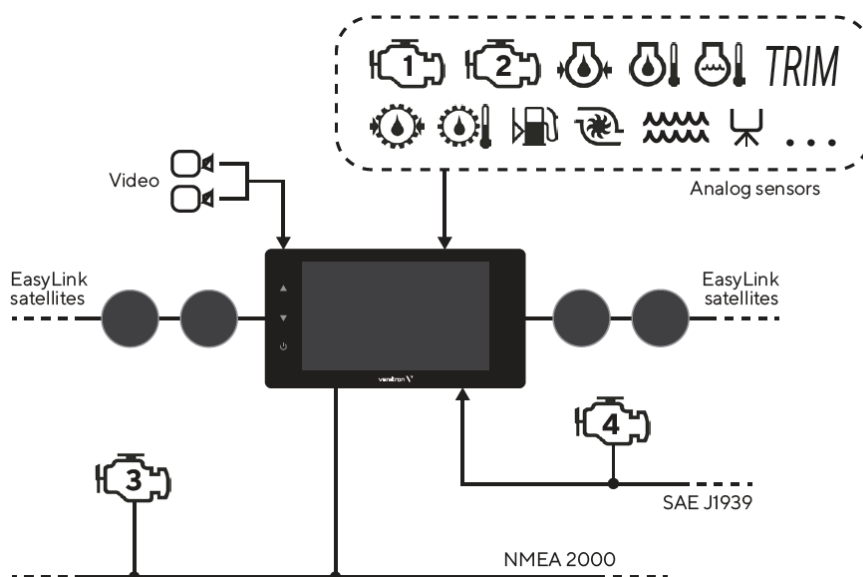

# INDICAZIONI PER LA SICUREZZA

## AVVERTENZA

- Non fumare! Evitare fiamme libere o fonti di calore!

- Il prodotto è stato messo a punto, fabbricato e controllato secondo i requisiti fondamentali di sicurezza della direttiva CE e in base agli standard tecnici comunemente accettati.
- Questo prodotto è stato progettato per l'utilizzo su imbarcazioni da diporto e non per utilizzo professionale.
- L'apparecchio è destinato all'uso in veicoli e macchine messi a terra e per l'uso nella navigazione sportiva compresa quella professionale non classificata.
- Utilizzare il prodotto esclusivamente per l'uso per cui è previsto. Le conseguenze di un utilizzo improprio del prodotto possono causare lesioni a persone e danni a cose o all'ambiente. Prima del montaggio accertarsi del tipo di veicolo e della presenza di eventuali particolarità deducendo i dati necessari dai documenti del veicolo!
- Accertarsi in base ai disegni costruttivi della posizione dei condotti del carburante/della parte idraulica/ dei condotti elettrici e dell'aria compressa!
- Tenere conto nel montaggio di eventuali modifiche apportate al veicolo.
- Per effettuare il montaggio è necessario avere nozioni di base in campo automobilistico/nella parte elettrica e meccanica delle costruzioni navali allo scopo di evitare lesioni a persone, danni a cose e all'ambiente.
- Accertarsi che sia impossibile mettere inavvertitamente in moto il motore durante le operazioni di montaggio!
- Modifiche o manipolazioni del prodotto veratron possono compromettere la sicurezza. Non sono pertanto ammesse manovre di modifica o manipolazione.
- Per il montaggio/lo smontaggio dei sedili, ricoperture ecc. accertarsi di non danneggiare cavi né staccare collegamenti a spina.
- Annotare tutti i dati relativi ad altri apparecchi installati con memoria elettronica transitoria.

## SICUREZZA DURANTE IL MONTAGGIO

- Nell'esecuzione del montaggio accertarsi che i componenti del prodotto non condizionino né compromettano le funzioni del veicolo e che non si danneggino!
- Montare esclusivamente pezzi integri sul veicolo!
- Durante il montaggio accertarsi che il campo visivo non venga compromesso dal prodotto e che il prodotto non venga posizionato in un punto in cui possa entrare in collisione con la testa del conducente e del passeggero.
- Far eseguire il montaggio del prodotto da un addetto specializzato. Se si desidera effettuare personalmente il montaggio indossare abbigliamento da lavoro adeguato non largo perché potrebbe impigliarsi nelle parti mobili. Se necessario indossare una retina per i capelli lunghi.
- Per lavorare alla parte elettrica di bordo non portare gioielli metallici o in materiale conduttore come collane, bracciali, anelli ecc.
- Prestare particolare cautela allo svolgimento di eventuali lavori con il motore acceso. Portare solo abbigliamento da lavoro adeguato per evitare possibili rischi di lesioni da schiacciamento o scottatura.
- Prima di iniziare a lavorare staccare il morsetto del polo negativo della batteria per evitare il rischio di corto circuito. Se il veicolo è dotato di batterie supplementari occorre staccare eventualmente anche il polo negativo di tutte le batterie. I corti circuiti possono bruciare i cavi, far esplodere le batterie e causare danni ad altri sistemi elettronici. Ricordarsi che staccando la batteria tutti i dati inseriti nella



## INDICAZIONI PER LA SICUREZZA

memoria elettronica transitoria andranno persi e dovranno essere riprogrammati.

- Nelle barche con motore a benzina accendere il ventilatore del motore prima di iniziare a lavorare al vano motore.
- Attenzione al percorso di cavi o fasci di fili per evitare di danneggiarli durante operazioni di perforazione e taglio con la sega!
- Non effettuare il montaggio nella parte meccanica ed elettrica dell'airbag!
- Non praticare fori né aperture in sostegni o longheroni portanti o stabilizzanti!
- Prima di lavorare sotto il veicolo metterlo in sicurezza come indicato dal produttore.
- Il punto in cui effettuare il montaggio deve avere uno spazio libero sufficiente dietro i fori o le aperture di montaggio. La profondità di lavoro necessaria è di 65 mm.
- Praticare dei fori piccoli con il trapano, utilizzando una fresa conica eventualmente ingrandirli con una fresatura conica, con una sega da traforo, una sega a coda o con una lima e rifinirli. Sbavare i bordi. Attenersi

assolutamente alle indicazioni di sicurezza del produttore dell'utensile.

- Per i lavori per cui è necessario interrompere la tensione utilizzare esclusivamente un utensile isolato.
- Per la misurazione della tensione e della corrente nel veicolo/macchina o barca utilizzare solo l'apposito multimetro o lampade di controllo a diodi. L'impiego delle tradizionali lampade di controllo può causare danni agli apparecchi di controllo o ad altri sistemi elettronici.
- Le uscite elettriche degli indicatori e i cavi collegati non devono essere a contatto diretto e devono essere protette da possibili danneggiamenti. A questo scopo i cavi utilizzati devono essere sufficientemente isolati e avere una sufficiente resistenza alla tensione. I punti di contatto devono essere sicuri se toccati.
- Anche le parti conduttrici elettriche del dispositivo assorbitore di corrente collegato vanno protette dal contatto diretto mediante adeguate misure. È vietata la posa di cavi metallici e contatti non rivestiti.

## SICUREZZA DOPO IL MONTAGGIO

- Il cavo di massa sia ben fisso al polo negativo della batteria.
- Riprogrammare/programmare i valori della memoria elettronica transitoria.

- Verificare tutte le funzioni.
- Per la pulizia dei componenti utilizzare solo acqua pulita. Rispettare i tipi di protezione IP (IEC 60529).

## COLLEGAMENTO ELETTRICO

- Utilizzare solo il cavo con la sezione richiesta!
- Riducendo la sezione del diametro del cavo si ottiene una maggiore densità della corrente con conseguente riscaldamento della parte di cavo interessata!
- Nella posa dei cavi elettrici utilizzare le canaline e le fascette di cavi presenti non mettendo però i cavi parallelamente a quelli dell'accensione o parallelamente a quelli di dispositivi che assorbono molta corrente.
- Fissare i cavi con le apposite fascette o nastri. Non farli passare su parti mobili e non fissarli al piantone dello sterzo!
- Assicurarci che i cavi non siano esposti a trazioni, pressioni o a condizioni in cui possano essere recisi.

- Se i cavi passano attraverso i fori proteggerli con passanti isolanti in gomma o simili.
- Per isolare i cavi utilizzare una pinza isolante maneggiandola in modo da evitare danni o tagli di cavetti.
- Unire i nuovi collegamenti praticati tra i cavi solo con saldature dolci o utilizzare il collegamento a pressione comunemente in commercio!
- Effettuare i collegamenti a pressione solo con una pinza pressacavi attenendosi alle indicazioni di sicurezza del produttore dell'utensile.
- Isolare i cavetti liberi per evitare corto circuiti.
- **Attenzione:** pericolo di corto circuito causato da collegamenti difettosi o cavi danneggiati.

- I corto circuiti alla rete di bordo possono bruciare cavi, causare esplosioni delle batterie e danni di altri sistemi elettronici, perciò tutti i collegamenti dell'alimentazione di tensione vanno dotati di giunti di testa saldabili e devono essere sufficientemente isolati.
- Verificare in particolare l'efficienza dei collegamenti a massa.
- I collegamenti sbagliati possono causare corto circuiti. Collegare i cavi solo seguendo lo schema elettrico degli attacchi.
- Per il funzionamento dell'apparecchio con alimentatori di rete assicurarsi che gli alimentatori siano stabili e che siano stati prodotti in conformità alle seguenti norme: DIN EN 61000 – parte 6-1 fino al punto 6-4.

# INSTALLAZIONE

## ⚠ ATTENZIONE

Prima di iniziare a lavorare staccare il morsetto del polo negativo della batteria per evitare il rischio di corto circuito. Se il veicolo è dotato di batterie supplementari occorre staccare eventualmente anche il polo negativo di tutte le batterie. I corto circuiti possono bruciare i cavi, far esplodere le batterie e causare danni ad altri sistemi elettronici. Ricordarsi che staccando la batteria tutti i dati inseriti nelle memorie elettroniche transitorie andranno persi e dovranno essere riprogrammati.

### PRIMA DEL MONTAGGIO

1. Prima di iniziare a lavorare spegnere l'accensione ad estrarre la chiave di accensione.

Eventualmente rimuovere l'interruttore principale della corrente.

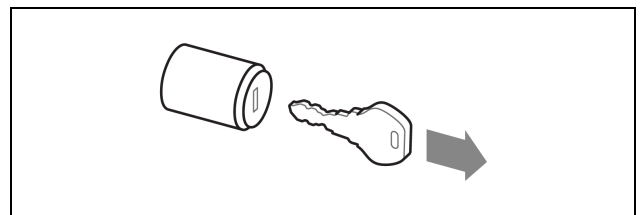

2. Staccare il polo negativo della batteria. Evitare che la batteria possa erroneamente essere ricollegata.

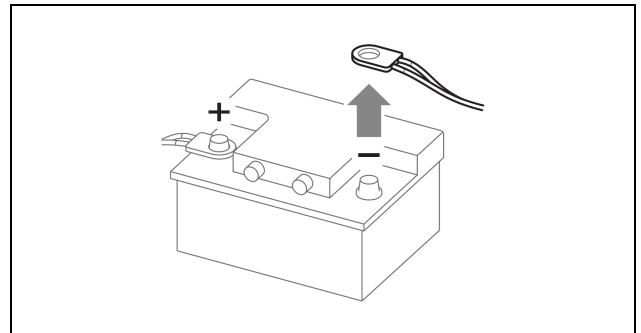

3. In caso di montaggio del display in prossimità di una bussola magnetica mantenere la distanza di protezione dalla bussola.

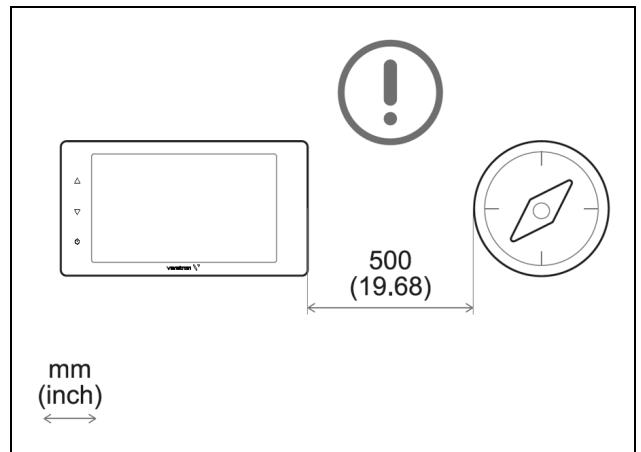

4. Se necessari, acquistare un cavo di derivazione NMEA 2000 con connettore M12 a cinque poli (lunghezza massima 6 m) e un cavo video con connettore M12 a quattro poli compatibile (A2C1845710001).

Questi accessori non sono inclusi.

**MONTAGGIO A PANNELLO**

**ATTENZIONE**

- Non praticare fori o aperture di installazione nelle travi di sostegno o di stabilizzazione!
- La posizione di montaggio deve avere uno spazio sufficiente dietro i fori o le aperture di montaggio.

1. Praticare un foro rettangolare nel pannello utilizzando la dima di foratura (vedere la pagina successiva di questo documento) e tenendo conto delle dimensioni del dispositivo [A].

2. Inserire le quattro viti di fissaggio del kit di installazione sul retro del dispositivo.

3. Far passare i cavi attraverso il foro e collegare i connettori.

**NOTA:** avvitare con cura i connettori M12. Se si avvitano con difficoltà, rimuoverli e riavvitarli.

4. Inserire il dispositivo dalla parte anteriore e stringere i quattro dadi in cima ai morsetti di plastica per tirare il display verso il pannello. [B]

5. Rimuovere la pellicola di protezione dal display e accertarsi che sia pulito ed asciutto.

6. Installare la cover di protezione appoggiandola sulla parte frontale del display e premendola ai lati con le dita per agganciarla stabilmente.

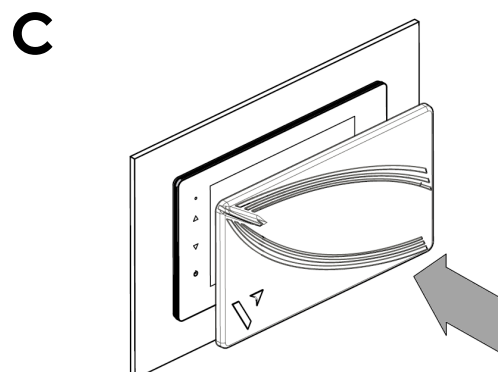
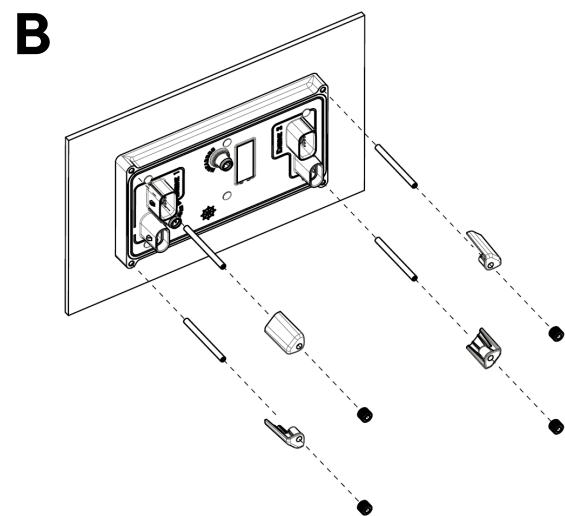
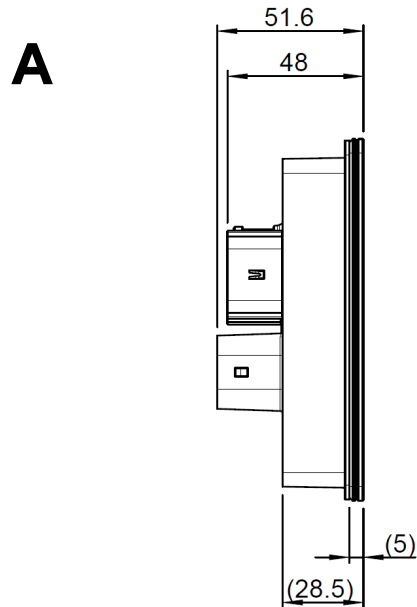

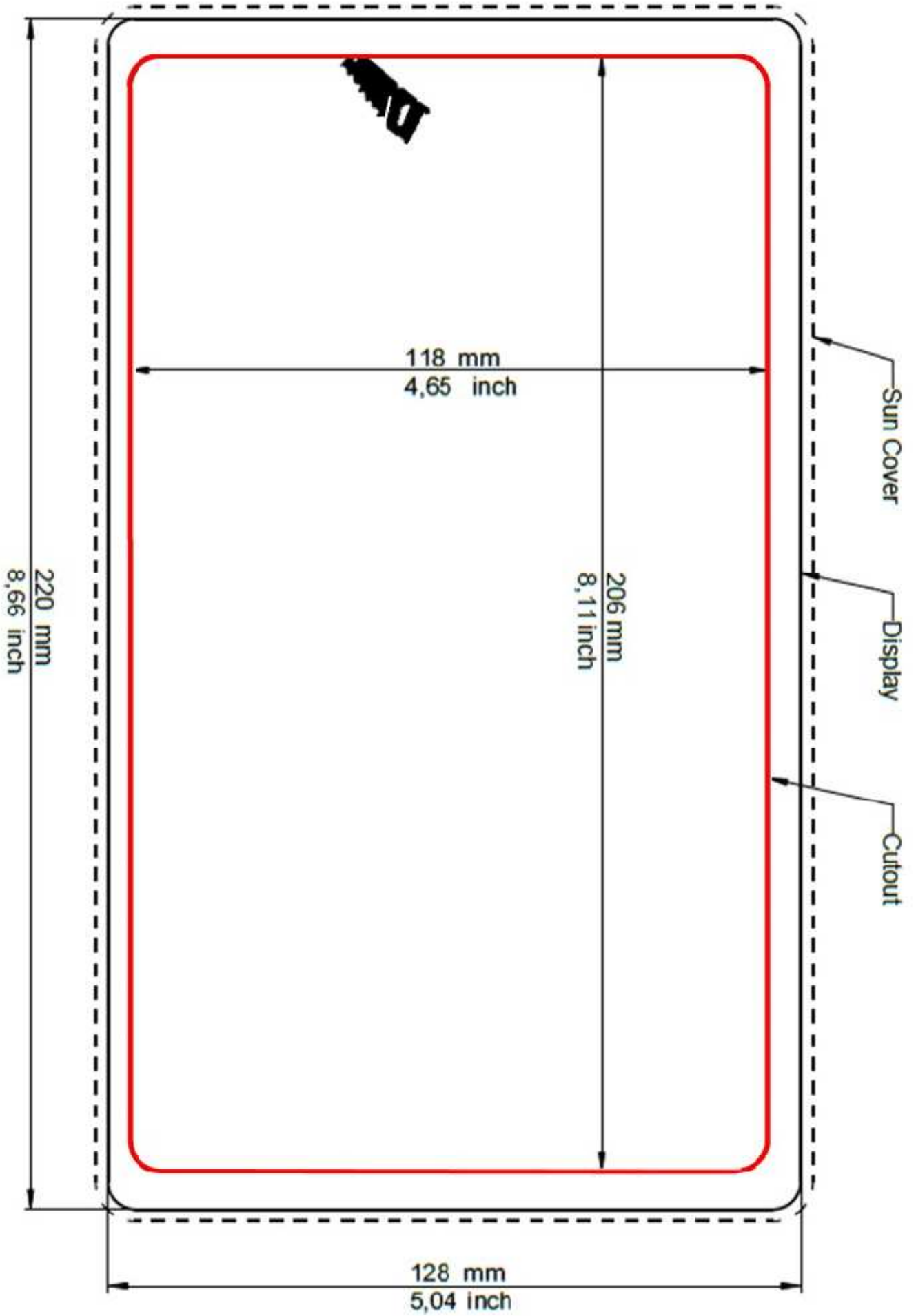

# COLLEGAMENTI ELETTRICI

## ⚠ ATTENZIONE

- Fare riferimento alle norme di sicurezza descritte nella sezione collegamenti elettrici del capitolo Informazioni sulla sicurezza di questo documento!

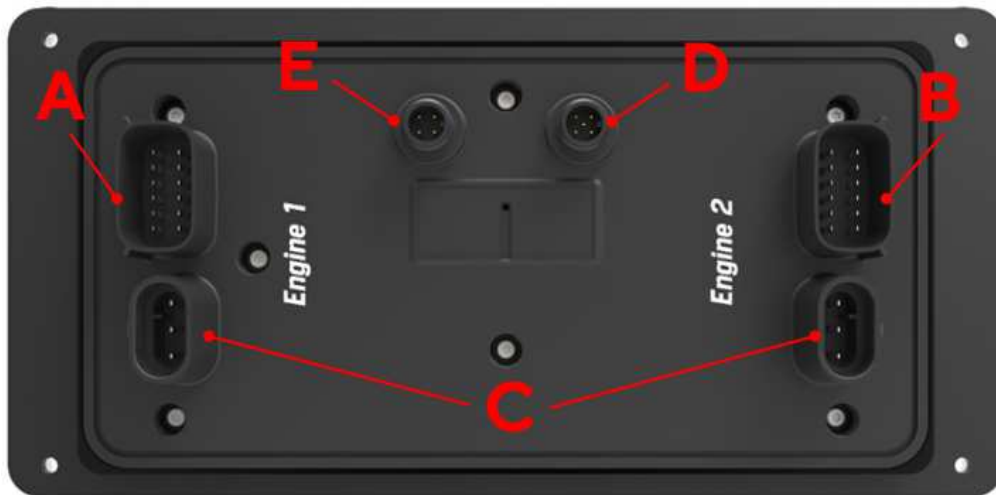

### CONNETTORE ENGINE 1 [A]

| Pin | Colore       | Descrizione                            |
|-----|--------------|--|
| 1   | Rosso        | KL. 30 - Positivo permanente 12 / 24 V |
| 2   | Nero         | KL. 31 - Massa                         |
| 3   | Bianco       | Uscita di allarme                      |
| 4   | Verde        | Segnale del sensore di frequenza - RPM |
| 5   | Blu          | SAE J1939 - CAN Low                    |
| 6   | Blu / Bianco | SAE J1939 - CAN High                   |
| 7   | Giallo       | KL. 15 - Accensione positiva           |
| 8   | Grigio       | Ingresso sensore resistivo             |
| 9   | Marrone      | Ingresso sensore resistivo             |
| 10  | Arancione    | Ingresso sensore 0-5 V                 |
| 11  | Azzurro      | Ingresso sensore 4-20 mA               |
| 12  | Viola        | Ingresso sensore 4-20 mA               |

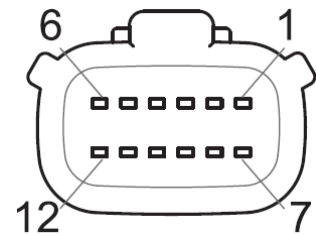

Connettore Molex MX150 a 12 poli, vista cavo e cablaggio A2C1507870001 (in dotazione)

## CONNETTORE ENGINE 2 [B]

| Pin | Colore       | Descrizione                            |
|-----|--------------|--|
| 1   | Rosa         | Ingresso di allarme configurabile      |
| 2   | Nero         | KL. 31 - Massa                         |
| 3   | Bianco       | Uscita di allarme                      |
| 4   | Verde        | Segnale del sensore di frequenza - RPM |
| 5   | Blu          | SAE J1939 - CAN Low                    |
| 6   | Blu / Bianco | SAE J1939 - CAN High                   |
| 7   | Giallo       | Ingresso sensore 0-5 V                 |
| 8   | Grigio       | Ingresso sensore resistivo             |
| 9   | Marrone      | Ingresso sensore resistivo             |
| 10  | Arancione    | Ingresso sensore 0-5 V                 |
| 11  | Azzurro      | Ingresso sensore resistivo             |
| 12  | Viola        | Ingresso sensore resistivo             |

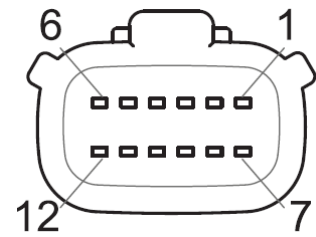

Connettore Molex MX150 a 12 poli, vista cavo e cablaggio A2C1507870001 (in dotazione)

## CONNETTORI EASYLINK [C]

| Pin | Descrizione        |
|-----|--------------------|
| 1   | Alimentazione 12 V |
| 2   | Massa              |
| 3   | Dati EasyLink      |

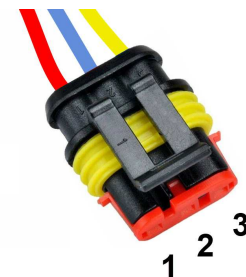

Connettore AMP SuperSeal 1,5 a 3 poli femmina, vista cavo

L'interfaccia EasyLink è destinata al collegamento dei satelliti VMH 14.

È possibile collegare fino a 16 indicatori per canale (in cascata), come mostrato nell'immagine a destra.

Ogni canale può visualizzare i dati di un motore. Il motore visualizzato può essere configurato in [SYSTEM CONFIGURATION] > [EasyLink].

Gli indicatori della serie OceanLink non sono supportati.

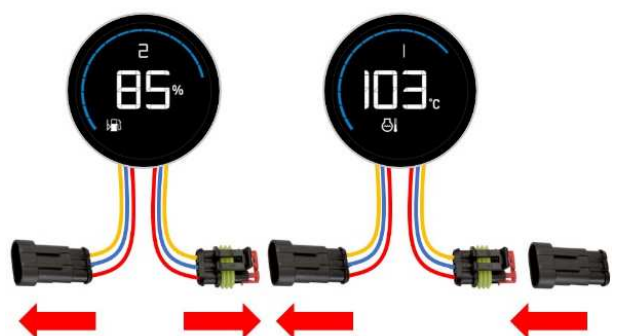

**CONNETTORE NMEA 2000® [D]**

| Pin | Descrizione   |
|-----|---------------|
| 1   | Schermatura   |
| 2   | NET-S (V+)    |
| 3   | NET-C (V-)    |
| 4   | NET-H (CAN H) |
| 5   | NET-L (CAN L) |

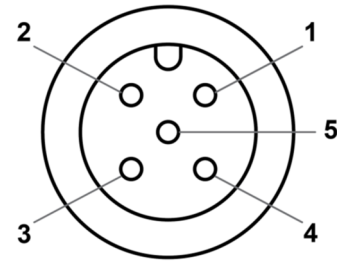

Connettore Micro-C M12 5 poli maschio, vista cavo

Una volta completata l'installazione, è possibile interfacciare il dispositivo alla rete NMEA 2000® attraverso il connettore dedicato [D].

Assicurarsi di serrare il connettore M12 avvitandolo sulla sua controparte per preservarne l'impermeabilità.

È necessario un cavo di derivazione accessorio (non incluso).

Si noti che NMEA 2000® non consente cavi di derivazione di lunghezza superiore a 6 metri.

Per una corretta progettazione della rete, fare riferimento allo standard NMEA 2000®.

**CONNETTORE VIDEO [E]**

| Pin | Descrizione      |
|-----|------------------|
| 1   | Ingresso video 2 |
| 2   | Ingresso video 1 |
| 3   | Massa video 2    |
| 4   | Massa video 1    |

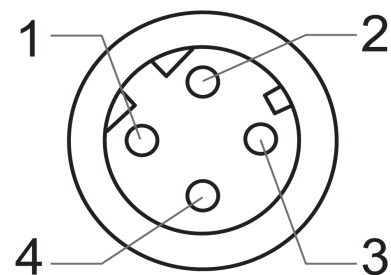

Connettore M12 a 4 poli femmina, vista cavo



## SCHEMA ELETTRICO

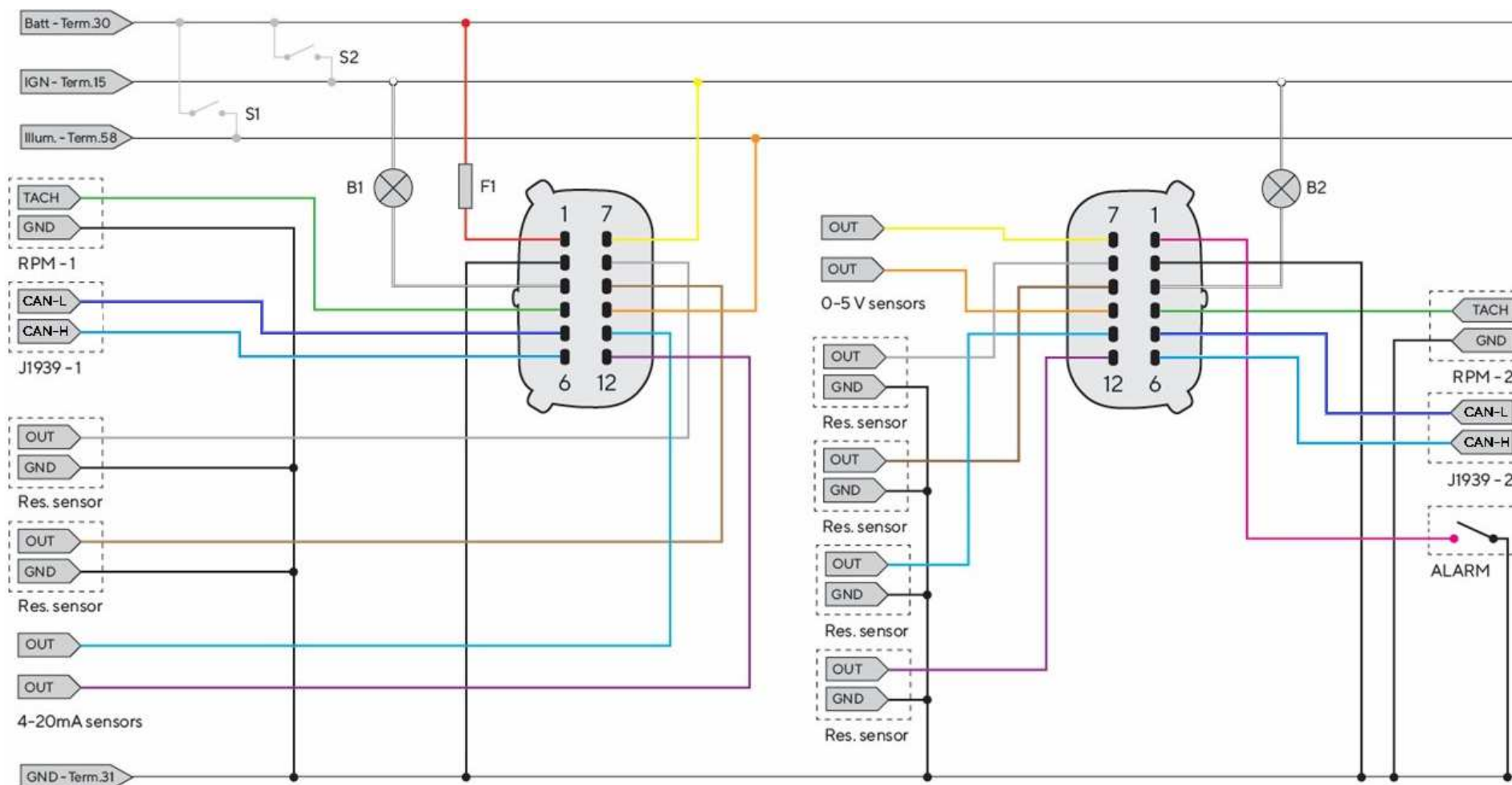

## Denominazioni nello schema elettrico

**Batt** - Term.30 - Positivo permanente 12/24 V

**IGN** - Term. 15 - Positivo di accensione

**GND** - Term. 31 - Massa

**Illum.** - Term.58 - Illuminazione

**S1** - Interruttore modalità giorno/notte (non incluso)

**S2** - Chiave di accensione

**F1** - Fusibile da 3A (non incluso)

**B1/B2** - Allarme acustico esterno (non incluso)

**RES** - Ingressi resistivi

**RPM** - Ingressi in frequenza

**ALARM** - Allarme digitale esterno

**J1939** - Porte CAN SAE J1939

## COLLEGAMENTO DEL CONTAGIRI

Il segnale del contagiri può essere ottenuto da diverse fonti, rispettivamente dal terminale "W" dell'alternatore, dal terminale "1" della bobina di accensione o da sensori dedicati come un generatore o un sensore induttivo.

È consigliabile utilizzare sensori con massa isolata ed è necessario assicurarsi che la massa del sensore sia collegata alla massa del display per evitare letture errate.

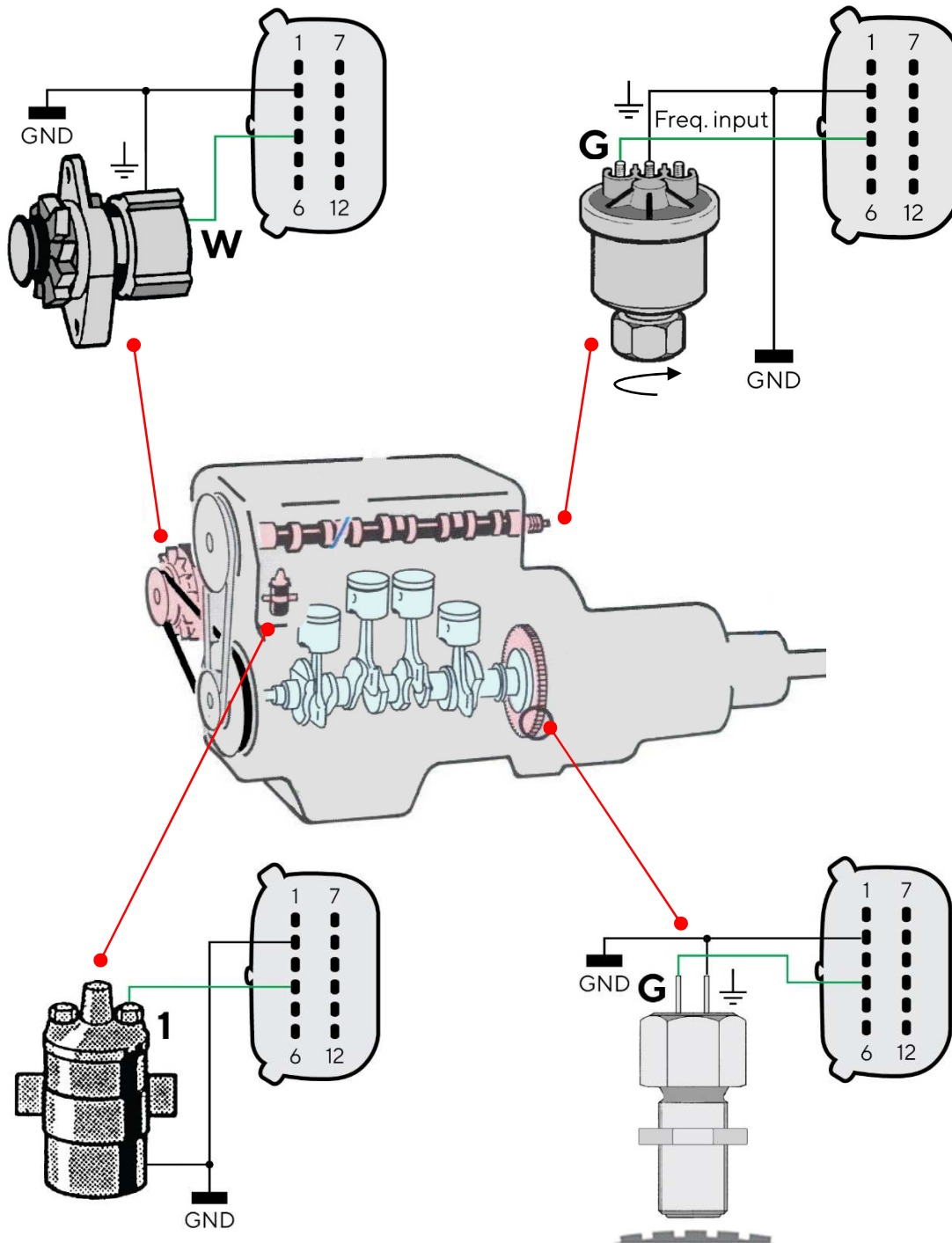

## COLLEGAMENTO DEI SENSORI RESISTIVI

Qualsiasi sensore collegato a un ingresso resistivo del display deve essere collegato come indicato in figura. È consigliabile utilizzare sensori con massa isolata ed è necessario assicurarsi che la massa del sensore sia collegata alla massa del display per evitare letture errate.

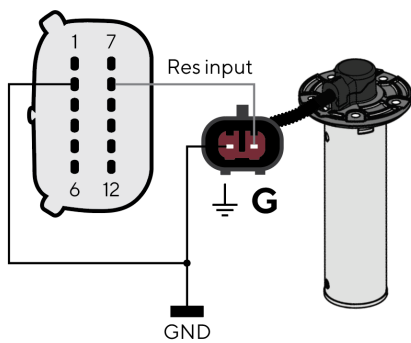

Sensore di livello collegato all'ingresso resistivo 8

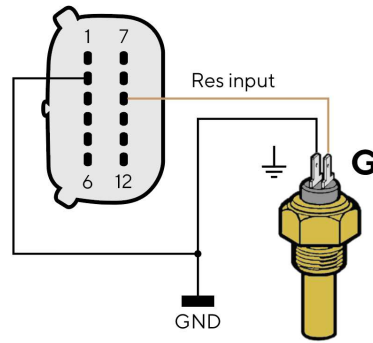

Sensore di temperatura con massa isolata collegato all'ingresso resistivo 9

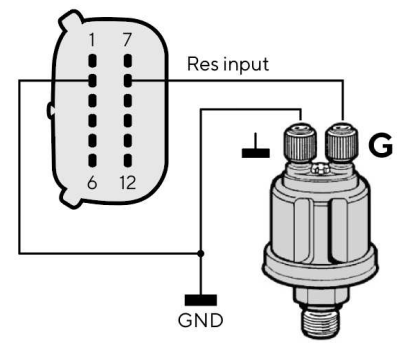

Sensore di pressione con massa isolata collegato all'ingresso resistivo 8

## COLLEGAMENTO DELL'ALLARME ESTERNO (B1)

Il display supporta il collegamento di due allarmi esterni (B1/B2) tramite le uscite di allarme dedicate.

Il cicalino/spia può essere alimentato a diverse tensioni (consultare il manuale del produttore), poiché l'uscita di allarme è collegata alla massa all'interno del display.

È importante notare che la corrente massima supportata è di 500 mA.

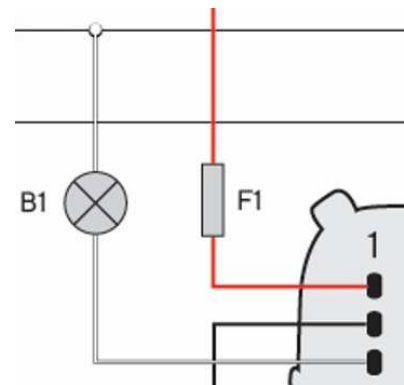

## SELETTORE MODALITÀ GIORNO/NOTTE (S1)

Il display consente di impostare due livelli di illuminazione, uno per il giorno e uno per la notte.

È possibile passare dalla modalità giorno a quella notte tramite un interruttore esterno al display (S1) collegato all'alimentazione (KL.30), oppure collegandosi al segnale dell'illuminazione di bordo KL.58, se presente.

Ogni ingresso 0-5V del display può essere configurato a questo scopo (vedere "Configurazione dei sensori").

Per impostare la modalità desiderata, deviare il pin di ingresso selezionato come segue:

| Per impostare la modalità... |  |
|------------------------------|--|
| giorno                       | deviare l'ingresso a <b>MASSA/C. APERTO</b> .          |
| notte                        | deviare l'ingresso verso il <b>POSITIVO BATTERIA</b> . |

Nelle impostazioni del sensore, la funzione del relativo ingresso in tensione deve essere definita come ingresso di illuminazione.

**PRIORITÀ DEI SEGNALI RICEVUTI**

Se lo stesso dato fosse ricevuto da più di una sorgente, la priorità del segnale ricevuto è la seguente:

- Ingresso analogico
- SAE J1939
- NMEA 2000

# PER INIZIARE

## FUNZIONAMENTO

Durante il normale funzionamento, il display visualizza una delle dieci pagine di dati personalizzabili. Scorrere il touchscreen a sinistra o a destra per scorrere le pagine.

Per accedere al menu del VMH 70, premere il bottone MENU nell'angolo inferiore sinistro dello schermo. Questo pulsante conduce al menu principale, dal quale sono disponibili quattro sottomenu:



- **System configuration**  
Modificare i settaggi per il display stesso, come la luminosità, le unità di misura o l'orologio.
- **Screens configuration**  
Eliminare le schermate, aggiungerne di nuove o personalizzare i dati da visualizzare su quelle attuali.
- **Alarms**  
Vedere gli allarmi attivi e definirne le impostazioni per la visualizzazione, inclusa l'attivazione dell'allarme esterno.
- **Sensor configuration**  
Definire tutte le impostazioni per gli ingressi analogici.

Per ulteriori informazioni su questi menu, consultare i rispettivi capitoli di questo documento.

La luminosità del display può essere modificata in qualsiasi momento premendo i pulsanti touch sul lato sinistro del display.

## MODALITÀ STANDBY

Il display VMH 70 supporta una modalità standby, in cui il display viene spento per ridurre il consumo di corrente o semplicemente per non averlo illuminato in condizioni di oscurità quando non è necessario.

Si noti che durante la modalità standby l'unità è totalmente operativa e può essere riaccesa all'istante.

Per attivare la modalità standby, basta premere il pulsante con il simbolo di accensione.



## ACCENSIONE E SPEGNIMENTO

La modalità di accensione/spegnimento dipende dal segnale di accensione sul terminale 15 (collegato al connettore Engine 1, pin 7 - filo giallo).

All'accensione, vengono visualizzati il logo e la versione del software, seguiti da un messaggio di sicurezza e dall'ultima pagina di dati visualizzata prima dello spegnimento.



Mentre il VMH 70 è acceso, può essere settato in modalità standby come descritto sopra.

È possibile personalizzare l'immagine di avvio visualizzata all'accensione utilizzando il Veratron Configuration Tool.

Per ulteriori informazioni, rivolgersi ad un rivenditore Veratron.



## FUNZIONI DEI PULSANTI DEL MENU

Quando si accede ad un menu, una serie di pulsanti vengono visualizzati sul bordo destro del display. Utilizzarli per navigare nel menu come descritto nella tabella sottostante.

| Pulsante  | Nome      | Funzione   |
|---|-----------|--|
|  | INDIETRO  | <ul style="list-style-type: none"> <li>Ritorno al menu precedente</li> </ul>                           |
|  | SU<br>GIÙ | <ul style="list-style-type: none"> <li>Scorrimento delle varie opzioni del menu</li> </ul>             |
|  | ENTER     | <ul style="list-style-type: none"> <li>Aprire un sottomenu</li> <li>Confermare la selezione</li> </ul> |

## FUNZIONI DEI PULSANTI TOUCH

I seguenti pulsanti a sfioramento sono incorporati nel vetro del display a sinistra dello schermo. Durante la visualizzazione delle schermate dati, i pulsanti svolgono le seguenti funzioni:

| Pulsante  | Nome      | Funzione   |
|---|-----------|--|
|  | SU<br>GIÙ | <ul style="list-style-type: none"> <li>Modifica della luminosità dell'illuminazione</li> </ul>   |
|  | STANDBY   | <ul style="list-style-type: none"> <li>Premere questo pulsante per portare il display in modalità standby o per avviarlo dopo essere stato in standby. (Funziona solo se anche il segnale di accensione è attivo)</li> </ul> |

## PROCEDURA GUIDATA DI CALIBRAZIONE

La procedura guidata di calibrazione appare alla prima accensione del display, dopo un reset, e ad ogni accensione fino alla calibrazione dei sensori

Il display chiede di configurare i sensori.

Scegliere [Yes] per aprire il menu SENSOR CONFIGURATION.

Scegliere [No], per visualizzare la prima pagina di dati predefinita e configurare i sensori in seguito.

## IMPOSTARE LA MODALITÀ GIORNO/NOTTE

Esistono tre modi per impostare il display in modalità giorno o notte:

- **Ingresso illuminazione (Term.58)**

È possibile configurare uno degli ingressi analogici 0-5V come ingresso di illuminazione e collegarlo ad un interruttore esterno o al segnale di illuminazione della plancia, se presente.

Per ulteriori informazioni sull'installazione, vedere il capitolo "Selettore modalità giorno/notte (S1)" nella sezione "Collegamenti elettrici".

- **Sensore di luminosità integrato**

Abilitare il sensore di luminosità incorporato in [SYSTEM CONFIGURATION]>[DISPLAY]>[ Auto Day/Night Switch] in modo che il display passi automaticamente dalla modalità giorno a quella notturna in base alla luminosità dell'ambiente circostante.

- **Manualmente attraverso il menu**

Per passare manualmente da una modalità all'altra, selezionare la modalità desiderata nel menu [SYSTEM CONFIGURATION]>[DISPLAY]>[ILLUMINATION MODE].

## LISTA DI CONTROLLO PER L'AVVIO

Di seguito sono riportati i passaggi per la configurazione iniziale:

1. Collegare i sensori agli ingressi analogici.
2. All'accensione, leggere il messaggio di sicurezza, quindi selezionare [Yes] per aprire il menu SENSOR CONFIGURATION e definire i parametri del sensore (vedere "Configurazione dei sensori").
3. Configurare le impostazioni generali del display (vedere "Impostazioni di sistema").
4. Aggiungere/rimuovere pagine dati selezionando il layout migliore e i dati da visualizzare (vedere "Configurazione delle pagine dati").
5. Se si utilizza un layout con grafici a barre, personalizzare gli intervalli minimi e massimi (Impostazioni grafici a barre, vedere "Impostazioni di sistema").
6. Configurare gli allarmi locali, NMEA 2000 e J1939 (vedere "Gestione degli allarmi").

## CARICARE UN LOGO PERSONALIZZATO

È possibile caricare un logo personalizzato da PC utilizzando il Veratron Configuration Tool.

Tale logo verrà visualizzato ogni volta durante il processo di avvio.

Per ulteriori informazioni, consultare il manuale d'uso del Veratron Configuration Tool o contattare il proprio rivenditore Veratron.

# PAGINE DATI

Le pagine dati mostrano le informazioni ricevute dalle varie sorgenti.

Il display può memorizzare fino a 10 schermate.

Di default, vengono visualizzate cinque schermate [Dual Engine, NavDash, Quad Data, Battery Screen, Video].

La pagina degli allarmi appare in coda alle schermate definite se ci sono allarmi attivi.

## SCORRIMENTO DELLE SCHERMATE

Per scorrere le pagine, passare il dito sul touch screen in senso orizzontale. Per ulteriori informazioni sull'aggiunta, l'eliminazione e la modifica delle pagine, vedere "Configurazione delle pagine dati".

## LAYOUT DELLE PAGINE DATI

Ogni schermata contiene alcuni elementi comuni, che vengono sempre visualizzati indipendentemente dal layout scelto.

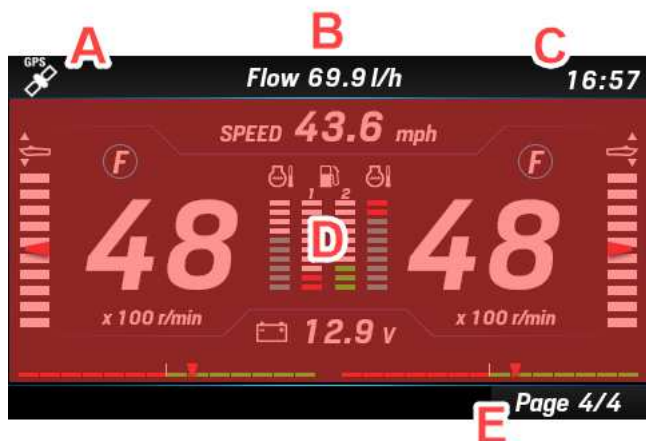

| Parte | Descrizione  |
|-------|--|
| A     | Disponibilità del segnale GPS (GPS non incluso)        |
| B     | Titolo della schermata o campo dati aggiuntivo (fisso) |
| C     | Ora GPS (se ricevuta)                                  |
| D     | Contenuto dello schermo                                |
| E     | Numero di pagina                                       |

Il contenuto della schermata [D] dipende dalla configurazione selezionata dall'utente per una specifica schermata (vedere "Configurazione della schermata").

Ogni schermata può essere personalizzata con uno dei seguenti layout disponibili:

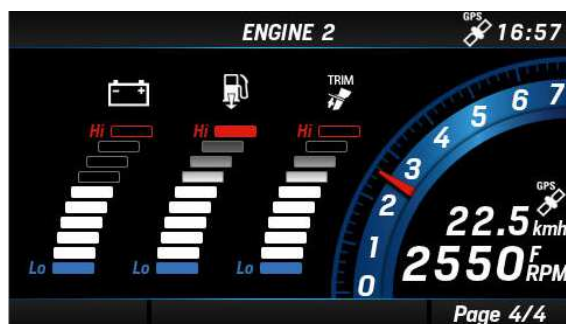

### Layout SINGLE ENGINE

con contagiri, velocità, e tre grafici a barre per i tre dati selezionati tra pressione di sovralimentazione, trim, temperatura del liquido di raffreddamento del motore, tensione della batteria e consumo di carburante.

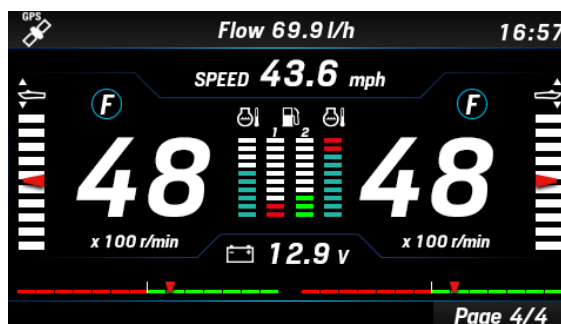

### Layout DUAL ENGINE

con tre grafici a barre per i tre dati definiti: trim, temperatura del liquido di raffreddamento del motore, livello del carburante. Vengono inoltre visualizzati l'angolo del timone, i contagiri, la tensione della batteria, la velocità e la marcia.



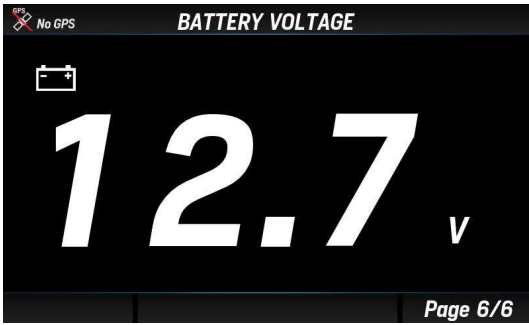

**Layout SINGLE**

Visualizzazione di un singolo dato numerico.



**Layout TRIPLE**

Da tre a nove dati numerici.

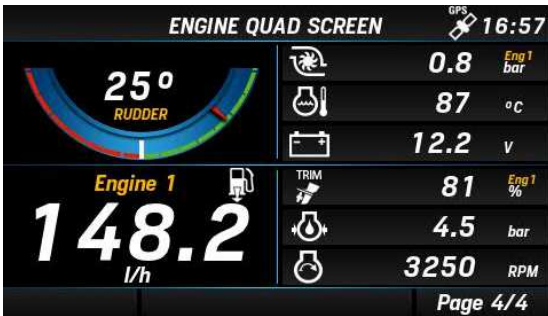

**Layout QUAD**

Da quattro a dodici dati numerici.

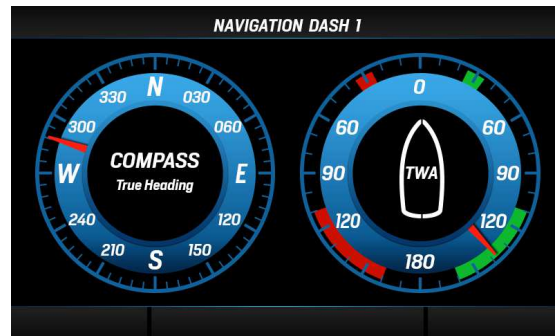

**Layout NAV DASH**

Questi layout consentono di visualizzare i dati in modo analogico. Sono disponibili tre varianti di due, tre o otto indicatori sullo schermo.

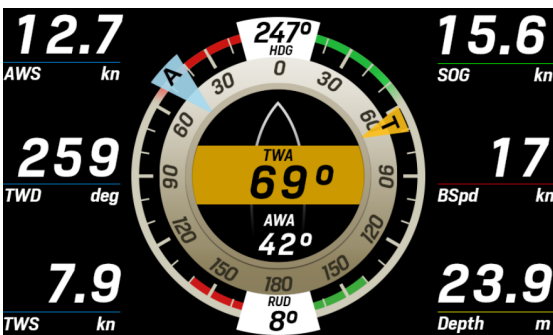

**Layout WIND**

Schermata dedicata alla navigazione con rappresentazione grafica dei dati del vento apparente e reale.

Sei campi dati numerici personalizzabili.

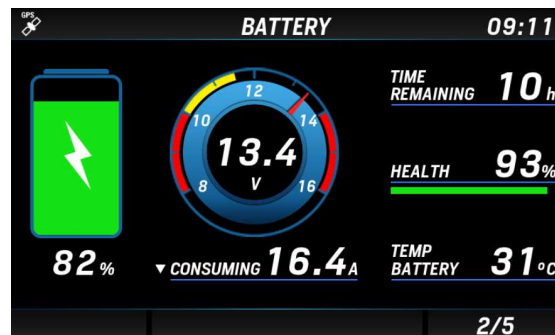

**Schermata INTELLIGENT BATTERY MONITOR**

Schermata dedicata al monitoraggio della batteria, che include informazioni dettagliate sulla batteria provenienti dall'Intelligent Battery Sensor (IBS).

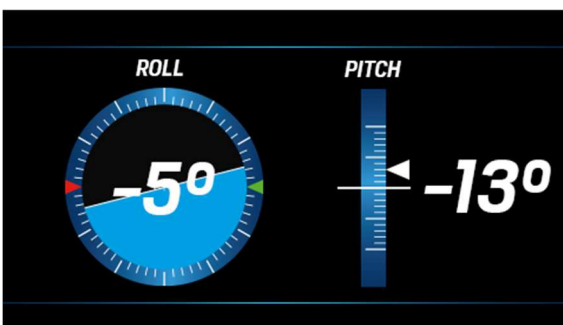

**Schermata PITCH AND ROLL**

Monitora l'inclinazione dell'imbarcazione, ad esempio con le informazioni ricevute dal multi-sensore NavSensor.

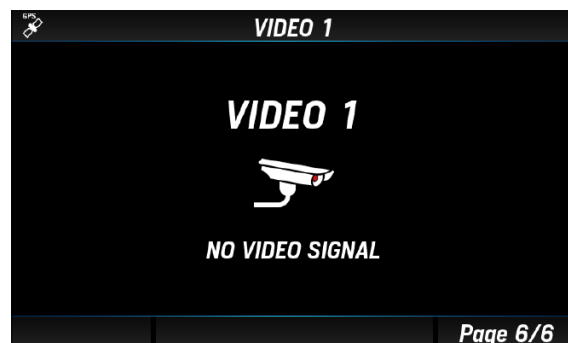









**Schermata VIDEO**

Visualizza il video ricevuto dalla videocamera esterna.

## DATI SUPPORTATI

| Icona       | Dati   | Ingresso  |           |           | Uscita    | Unità          |
|-------------|--|-----------|-----------|-----------|-----------|----------------|
|             |  | NMEA 2000 | SAE J1939 | Analogico | NMEA 2000 |                |
|             | Giri del motore                                      | x         | x         | x         | x         | giri al minuto |
|             | Trim   | x         | -         | x         | x         | %              |
|             | Pressione di sovralimentazione del motore            | x         | x         | x         | x         | bar, psi, kPa  |
|             | Temperatura del liquido di raffreddamento del motore | x         | x         | x         | x         | °C, °F         |
|             | Tensione della batteria                              | x         | -         | x         | -         | V              |
|             | Consumo di carburante                                | x         | -         | -         | -         | gal/h, L/h     |
|             | Pressione del carburante                             | x         | x         | -         | -         | bar, psi       |
|             | Temperatura di aspirazione dell'aria                 | -         | x         | -         | -         | °C, °F         |
| <b>LOAD</b> | Carico del motore                                    | x         | x         | -         | -         | %              |
|             | Temperatura gas di scarico                           | x         | x         | -         | -         | °C, °F         |
|             | Temperatura dell'olio motore                         | x         | x         | x         | x         | °C, °F         |
|             | Pressione dell'olio motore                           | x         | x         | x         | x         | bar, psi, kPa  |
|             | Temperatura dell'olio della trasmissione             | x         | x         | x         | x         | °C, °F         |
|             | Pressione dell'olio della trasmissione               | x         | x         | x         | x         | bar, psi, kPa  |
|             | Ore motore   | x         | x         | x         | x         | h              |
|             | Angolo del timone (127489)                           | x         | -         | x         | x         | °              |
|             | Profondità   | x         | -         | -         | -         | m, ft          |
|             | Livello del carburante (serbatoio: 1-4)              | x         | x         | x         | x         | %              |
|             | Livello dell'acqua dolce (serbatoio: 1-4)            | x         | -         | x         | x         | %              |
|             | Livello delle acque scure (serbatoio: 1-4)           | x         | -         | -         | x         | %              |
|             | Temperatura dell'acqua marina                        | x         | -         | -         | -         | °C, °F         |
| -           | Temperatura dell'aria                                | x         | -         | -         | -         | °C, °F         |
| <b>BARO</b> | Pressione atmosferica                                | x         | -         | -         | -         | hPa            |
|             | Bussola GPS (COG)                                    | x         | -         | -         | -         | °              |
|             | Bussola  | x         | -         | -         | x         | °              |

| Icona   | Dati                               | Ingresso  |           |           | Uscita    | Unità         |
|---|------------------------------------|-----------|-----------|-----------|-----------|---------------|
|   |                                    | NMEA 2000 | SAE J1939 | Analogico | NMEA 2000 |               |
| <b>AWA</b>  | Angolo del vento apparente (AWA)   | x         | -         | -         | x         | °             |
|  A | Velocità del vento apparente (AWS) | x         | -         | -         | x         | km/h          |
| <b>TWA</b>  | Angolo di vento vero (TWA)         | x         | -         | -         | -         | km/h          |
|  T | Velocità del vento reale (TWS)     | x         | -         | -         | x         | km/h          |
|    | Direzione del vento vero (TWD)     | x         | -         | -         | x         | °             |
|    | Velocità sull'acqua (STW)          | x         | -         | -         | -         | mph, kn, km/h |
|    | Distanza del viaggio               | -         | -         | -         | -         | km, mi, nm    |
|    | Tempo di viaggio                   | -         | -         | -         | -         | h             |
|    | Carburante per il viaggio          | -         | x         | -         | -         | L, gal        |
|    | Velocità GPS                       | x         | -         | -         | -         | mph, kn, km/h |
| -   | Angolo di rollio                   | x         | -         | -         | -         | °             |
| -   | Angolo di beccheggio               | x         | -         | -         | -         | °             |
| -   | Posizione                          | x         | -         | -         | -         | °             |
| <b>SOC</b>  | Carica della batteria              | x         | -         | -         | -         | %             |
| -   | Corrente della batteria            | x         | -         | -         | -         | A             |
| -   | Autonomia della batteria           | x         | -         | -         | -         | h, d          |
| <b>SOH</b>  | Salute della batteria              | x         | -         | -         | -         | %             |
| -   | Temperatura della batteria         | x         | -         | -         | -         | °C, °F        |

## ORE MOTORE

In assenza di dati ricevuti dalla rete NMEA 2000, l'indicatore considera il valore conteggiato internamente. Il tempo viene conteggiato come ore motore quando la velocità del motore è superiore a 300 giri/min. In presenza di dati provenienti dalla rete NMEA 2000, l'indicatore considera i dati ricevuti dalla rete solo se superiori ai dati interni.

## DISTANZA PERCORSO

L'indicatore calcola internamente la distanza percorsa in base alla velocità, tenendo conto del fattore di correzione impostato in [SENSOR CONFIGURATIONS] > [SPEED].

## LAYOUT NAVDASH

Il layout NavDash è disponibile in tre diverse configurazioni con due, tre, o otto indicatori circolari.

Ogni layout viene visualizzato in un colore blu o ambra e in modalità giorno o notte, a seconda dell'impostazione corrente del display.

Ogni indicatore può essere configurato per mostrare dati diversi, selezionabili tra i seguenti:

- Contagiri
- Profondità
- Angolo dei barra
- Angolo del vento apparente (AWA)
- Velocità del vento apparente (AWS)
- Bussola
- Velocità sull'acqua (STW)
- Velocità GPS (SOG)
- Livello del carburante
- Livello dell'acqua dolce
- Livello delle acque scure
- Trim
- Tensione della batteria
- Pressione dell'olio del motore e della trasmissione
- Temperatura dell'olio motore e della trasmissione
- Temperatura del liquido di raffreddamento

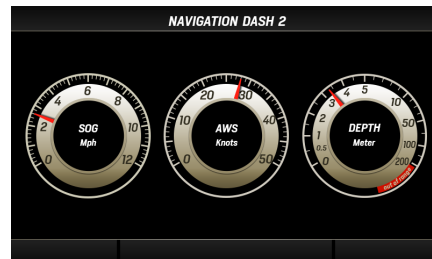
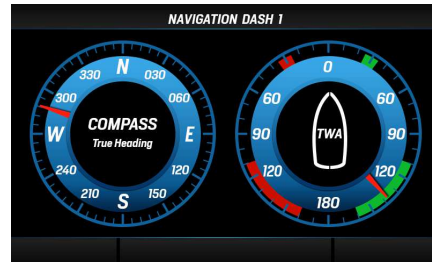

# CONFIGURAZIONE DELLE PAGINE DATI

Per accedere alle impostazioni di configurazione delle schermate, selezionare [SCREENS CONFIGURATION] nel MENU principale.



1. Accedere alla schermata HOME premendo [MENU] e selezionare [SCREENS CONFIGURATION].

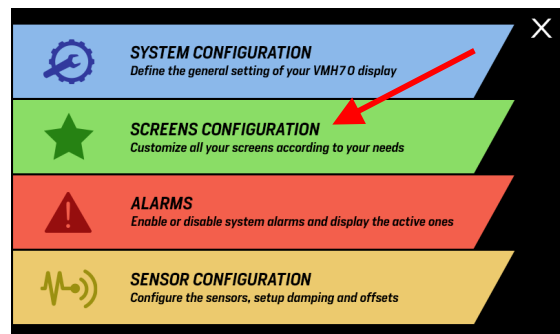

2. Scorrere le schermate preferite fino a visualizzare quella da personalizzare (o eliminare) e premere [ENTER] per confermare.

Per aggiungere una nuova schermata alla fine dei preferiti, basta scorrere fino a selezionare uno slot vuoto.

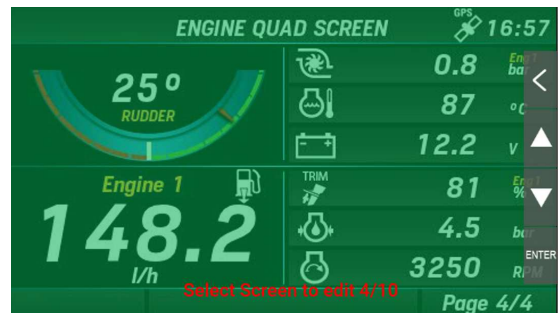

3. Scegliere il layout della nuova schermata tra quelli descritti in "Layout delle pagine dati".

Per eliminare la schermata selezionata, selezionare [REMOVE PAGE].

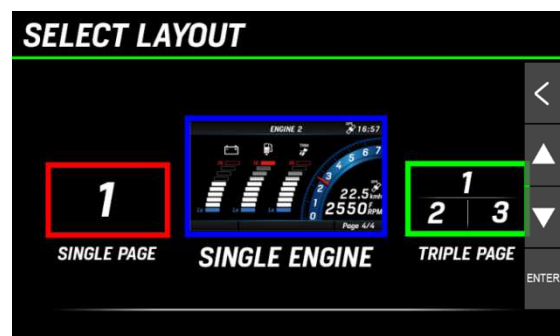

4. A seconda del layout scelto, è possibile personalizzare alcune parti della schermata, come i campi dati o i grafici a barre.

La voce attualmente selezionata è evidenziata in colore verde.

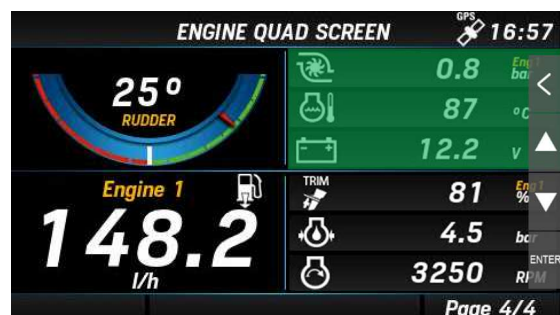

Premere ▲ o ▼ per selezionare il campo successivo.

## CONFIGURAZIONE DELLE PAGINE DATI

Scorrere le voci personalizzabili premendo i pulsanti SU e GIÙ.

Premere [ENTER] per selezionare il campo da personalizzare.

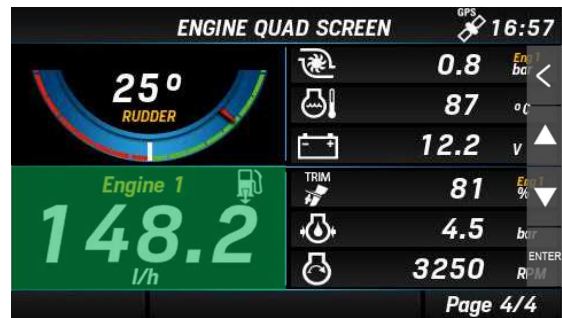

- Una volta selezionato, questo viene evidenziato in rosso.

Premere i pulsanti SU/GIÙ per modificare i dati visualizzabili.

Per l'elenco completo dei dati disponibili, consultare il capitolo "Dati supportati".

Premere [ENTER] per confermare la selezione e la voce viene nuovamente evidenziata in verde.

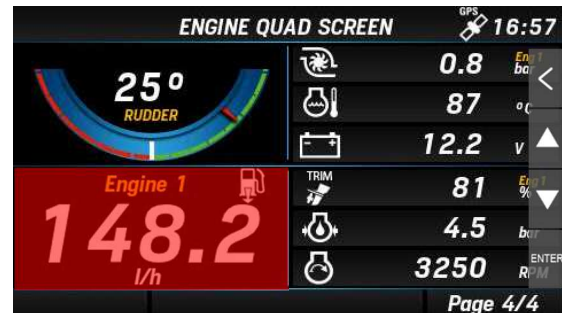

Premere ▲ o ▼ per modificare i dati.

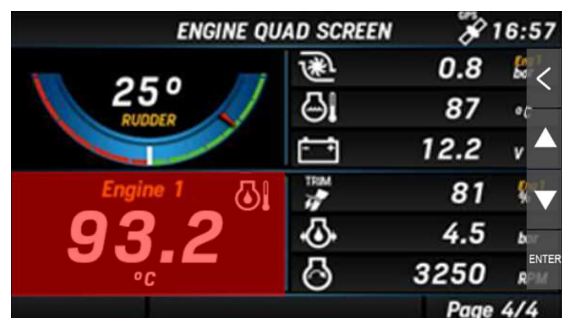

- Per personalizzare un'altra schermata, premere più volte [INDIETRO] fino a tornare alla selezione della schermata descritta al punto 2.

Per uscire dalle impostazioni e tornare alla schermata principale, premere più volte il tasto BACK.

# CONFIGURAZIONE DEL DISPLAY

Per accedere alle impostazioni del display, accedere alla schermata HOME premendo [MENU] e selezionare [SYSTEM CONFIGURATION].



## STRUTTURA DEL MENU

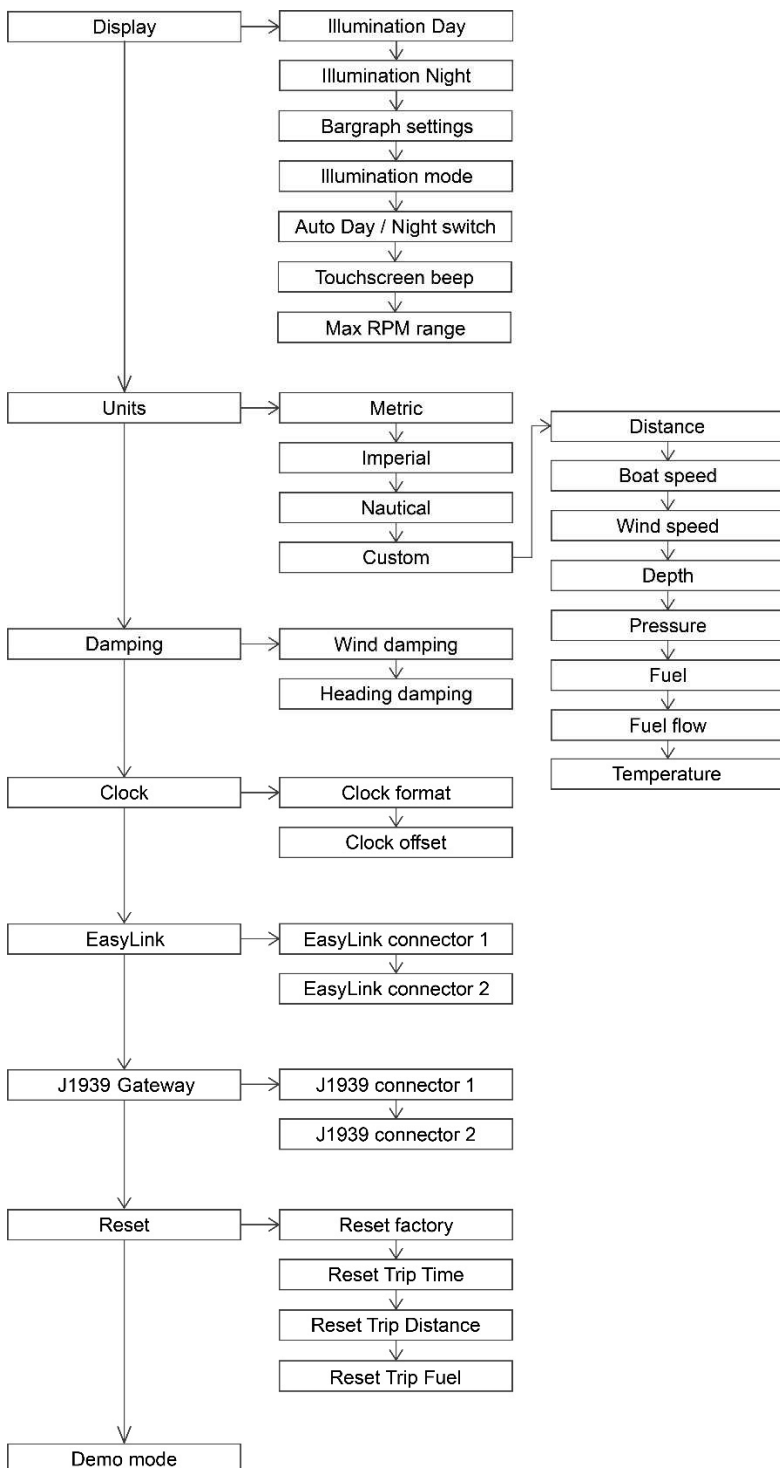

UTILIZZO DEL MENU SYSTEM CONFIGURATION

NOTA: il valore/comando sottolineato è quello settato di default.

| Impostazione                    | Descrizione   | Valori / comandi possibili   |
|---------------------------------|---|--|
| Display > Illumination Day      | Luminosità del display per la modalità giorno.<br><i>NOTA: questa impostazione influisce anche su tutti gli indicatori EasyLink.</i>  | 0-7, <u>Auto</u>   |
| Display > Illumination Night    | Luminosità del display per la modalità notturna.<br><i>NOTA: questa impostazione influisce anche su tutti gli indicatori EasyLink.</i>  | <u>0-7</u>   |
| Display > Bargraph settings     | Configurazione dei valori minimi e massimi per i grafici a barre.   | <ul style="list-style-type: none"> <li>• Pressione di sovralimentazione: 0-13 bar (default = 0-1)</li> <li>• Pressione olio 0-13 bar (default = 0-1)</li> <li>• Temperatura motore 0-300 °C (default = 0-200)</li> <li>• Tensione della batteria 8-32 V (default = 10-16)</li> <li>• Flusso di carburante 0-800 L/h (default = 0-150)</li> </ul>   |
| Display > Illumination mode     | Selezione della combinazione di colori per le varie schermate e del profilo di luminosità per ognuna.   | <ul style="list-style-type: none"> <li>• <b>Blue Day:</b> quadranti blu, numeri bianchi, illuminazione: <u>Z</u></li> <li>• <b>Blue Night:</b> quadranti blu, numeri rossi, illuminazione: <u>2</u></li> <li>• <b>Amber Day:</b> quadranti ambra, numeri bianchi, illuminazione: <u>Z</u></li> <li>• <b>Amber Night:</b> quadranti ambra, numeri rossi, illuminazione: <u>2</u></li> </ul> |
| Display > Auto Day/Night Switch | Abilita il sensore di luminosità integrato per passare automaticamente dalla modalità giorno a quella notturna.<br><i>NOTA: Questo è possibile solo se l'ingresso Illuminazione (termine 58) è disabilitato nelle configurazioni del sensore.</i> | <ul style="list-style-type: none"> <li>• <u>OFF</u> (spento)</li> <li>• Bright (Amb. luminoso)</li> <li>• Medium</li> <li>• Dark (Amb. scuro)</li> </ul>   |
| Display > Touchscreen Beep      | Abilita o disabilita il feedback sonoro per le interazioni con il touchscreen.  | • <u>On</u> / Off  |
| Display > Max RPM Range         | Selezionare l'intervallo di misurazione del regime del motore. I quadranti dei diversi layout si adattano a questo valore massimo.  | • 3000, <u>4000</u> , 7000   |
| Units                           | Unità di misura dei dati visualizzati.  | <ul style="list-style-type: none"> <li>• <u>Metrico</u></li> <li>• Imperiale</li> <li>• Nautico</li> <li>• Personalizzato</li> </ul>   |



## CONFIGURAZIONE DEL DISPLAY

| Impostazione  | Descrizione  | Valori / comandi possibili  |
|---|--|---|
| Damping ><br>Wind damping/<br>Heading damping                   | Smorzamento dei dati visualizzati relativi al vento e alla bussola.  | <ul style="list-style-type: none"> <li>No</li> <li><u>Low</u> (basso)</li> <li>Medium (medio)</li> <li>Hi (alto)</li> </ul>   |
| Clock ><br>Clock format   | Formato dell'orologio.   | <ul style="list-style-type: none"> <li><u>12h</u></li> <li>24 h</li> </ul>  |
| Clock ><br>Clock offset   | Impostazione del fuso orario.  | Da -12h a +12 h ( <u>0h</u> )   |
| EasyLink ><br>EasyLink connector<br>1 / EasyLink<br>connector 2 | <p>Quale motore e quali serbatoi devono essere visualizzati sui satelliti VMH 14 EasyLink.</p> <p>L'impostazione vale per tutti gli indicatori collegati su quel connettore.</p> <p>I satelliti OceanLink non sono supportati.</p> | <ul style="list-style-type: none"> <li>Mostra i dati del motore da: Motore <u>1-4</u></li> <li>Mostra il carburante da: Serbatoio <u>1-4</u></li> <li>Mostrare acqua dolce da: serbatoio <u>1-4</u></li> <li>Mostrare le acque reflue provenienti da: serbatoio <u>1-4</u></li> </ul> |
| J1939 ><br>Connector1 /<br>Connector 2                          | <p>Configurazione del gateway da SAE J1939 a NMEA 2000.</p> <p>Tutti i dati ricevuti dal bus J1939 saranno inviati su NMEA 2000 con l'istanza qui specificata.</p>   | <p>Send to NMEA 2000 As:</p> <ul style="list-style-type: none"> <li><u>Auto</u>: il display mantiene l'identificativo del motore J1939 anche per la rete NMEA 2000.</li> <li>Engine 1-4</li> </ul>  |
| Reset ><br>Reset factory  | Ripristinare le impostazioni di fabbrica del display.  | <ul style="list-style-type: none"> <li>Yes</li> <li><u>No</u></li> </ul>  |
| Reset ><br>Reset Trip time                                      |  | <ul style="list-style-type: none"> <li>Yes</li> <li><u>No</u></li> </ul>  |
| Reset ><br>Reset Trip Distance                                  |  | <ul style="list-style-type: none"> <li>Yes</li> <li><u>No</u></li> </ul>  |
| Reset ><br>Reset Trip Fuel                                      |  | <ul style="list-style-type: none"> <li>Yes</li> <li><u>No</u></li> </ul>  |
| Demo mode   | <p>Attivazione della modalità demo. I dati simulati NON vengono inviati su NMEA 2000.</p> <p><i>Nota: la modalità demo rimane attiva anche dopo il riavvio del display.</i></p>  | <ul style="list-style-type: none"> <li><u>On</u>: i dati del display vengono simulati. La simulazione viene inviata anche ai satelliti di EasyLink.</li> <li><u>Off</u>: la modalità demo è disattivata.</li> </ul>   |

UNITÀ DI MISURA

| Impostazione         | Metrico | Imperiale | Nautico | Personalizzato     |
|----------------------|---------|-----------|---------|--------------------|
| Distanza             | km      | mi        | nm      | km, mi, nm         |
| Velocità della barca | km/h    | mph       | kn      | km/h, mph, kn      |
| Velocità del vento   | km/h    | kn        | kn      | km/h, kn, m/s, bft |
| Profondità           | m       | ft        | ft      | m, ft              |
| Pressione            | bar     | psi       | psi     | bar, psi, kPa      |
| Carburante           | L       | gal       | gal     | L, gal             |
| Flusso di carburante | L/h     | gph       | gph     | L/h, gph           |
| Temperatura          | °C      | °F        | °F      | °C, °F             |

GATEWAY SAE J1939

Il display VMH è dotato di due porte SAE J1939 indipendenti per collegare i motori CAN al display e leggere i dati digitali provenienti da essi.

Assicurarsi di configurare correttamente il gateway J1939 in modo che tutti i dati del motore siano trasmessi su NMEA 2000 con l'identificativo corretto.

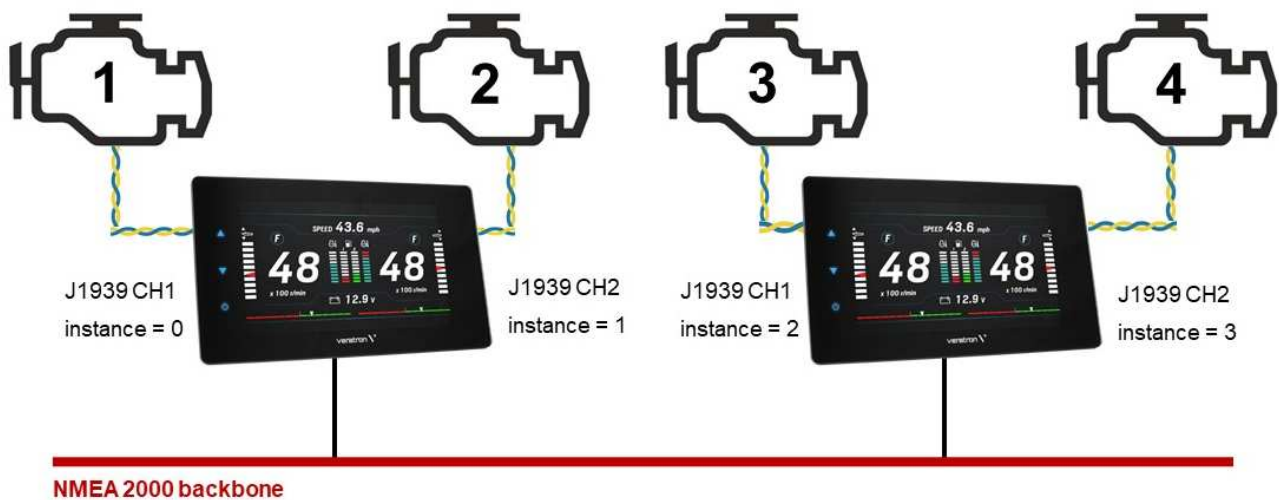

# CONFIGURAZIONE DEI SENSORI

Per accedere alle impostazioni dei sensori, accedere alla schermata HOME premendo il tasto MENU e selezionare [SENSOR CONFIG].



## STRUTTURA DEL MENU

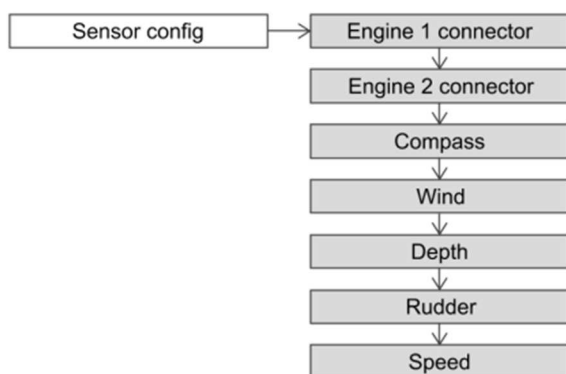

| Impostazione                    | Descrizione   | Valori possibili                      |
|---------------------------------|---|---------------------------------------|
| Engine 1 connector              | Configurare i sensori collegati al display attraverso gli ingressi analogici del connettore Engine 1 (vedere "Collegamenti elettrici"). | -                                     |
| Engine 2 connector              | Configurare i sensori collegati al display attraverso gli ingressi analogici del connettore Engine 2 (vedere "Collegamenti elettrici"). | -                                     |
| Compass > Heading offset        | Sfasamento angolare tra il Nord vero e la prua dell'imbarcazione.   | $\pm 0 - 180^\circ (0^\circ)$         |
| Compass > Variation             | Offset di variazione magnetica (differenza polare tra il Nord magnetico e il Nord vero)   | $\pm 0 - 180^\circ (0^\circ)$         |
| Compass > Send True Heading     | Attivare per consentire al display di trasmettere la rotta vera calcolata tramite NMEA 2000.  | Yes / No (No)                         |
| Wind > Wind direction offset    | Spostamento angolare tra la posizione $0^\circ$ del sensore del vento e l'asse longitudinale dell'imbarcazione.                         | $\pm 0 - 180^\circ (0^\circ)$         |
| Wind > Send True Wind           | Attivare per consentire al display di trasmettere i dati del vento vero calcolati internamente (TWA e TWS) tramite NMEA 2000.           | Yes / No (No)                         |
| Depth                           | Impostazione dell'offset di profondità rispetto al trasduttore. Positivo verso la linea di galleggiamento, negativo verso la chiglia.   | $\pm 0 - 9,9 \text{ m} (2 \text{ m})$ |
| Rudder                          | Configurazione dell'offset del timone.  | $\pm 0 - 120^\circ (0^\circ)$         |
| Speed > Speed correction factor | Correzione dei dati sulla velocità dell'imbarcazione ricevuti tramite NMEA 2000. Vedere "Calcolo dell'offset di velocità".              | 0 - 199.99 (1.00)                     |

CONFIGURAZIONE DI UN SENSORE COLLEGATO AL DISPLAY

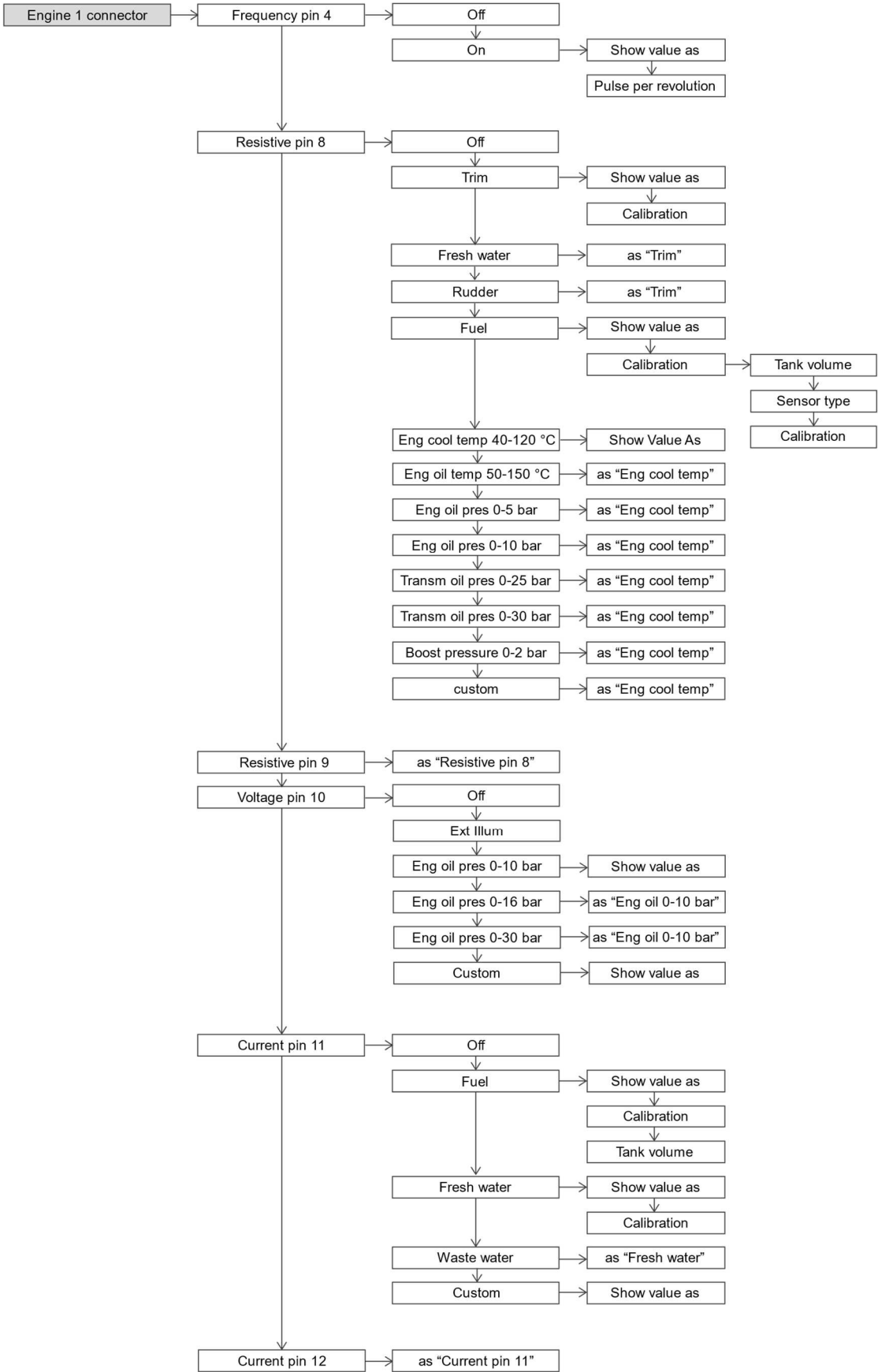

### 1. SELEZIONE DEGLI INGRESSI

Nel menu SENSOR CONFIG, selezionare "Engine 1 connector" o "Engine 2 connector" a seconda del connettore a cui è collegato elettricamente il sensore.

Selezionare quindi l'ingresso analogico (su quel connettore) a cui è cablata l'uscita del sensore.

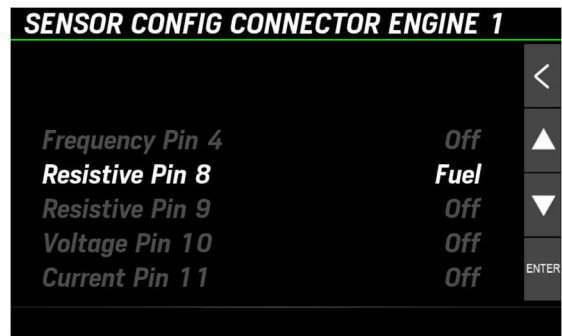

### 2. SCEGLIERE IL TIPO DI SENSORE

Selezionare il tipo di sensore collegato a quell'ingresso.

Per l'elenco completo dei sensori supportati, consultare il diagramma del menu.

Selezionare "Custom" per importare la configurazione completa del sensore dal Veratron Configuration Tool del PC.

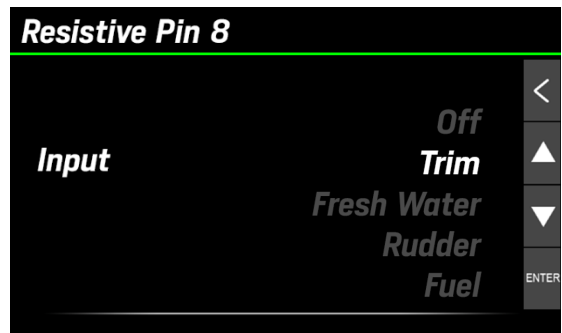

### 3. CONFIGURARE L'USCITA NMEA 2000

Il valore misurato per il sensore analogico viene trasmesso anche tramite NMEA 2000, quindi il display VMH fungerà da sorgente per questo dato.

Utilizzare la voce di menu "Show value as" per modificare l'istanza NMEA 2000 di quel sensore.

Se nella configurazione viene rilevato un conflitto di configurazione (ad esempio quando due sensori con la stessa istanza sono configurati su porte analogiche diverse), il display visualizza un avviso.

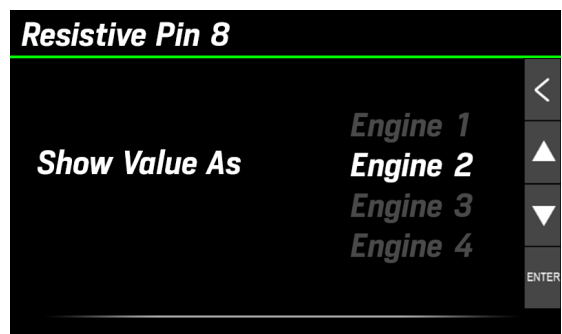

### 4. CALIBRARE IL SENSORE

Ogni tipo di sensore ha una calibrazione standard (vedere "Calibrazioni predefinite supportate"). I sensori Veratron sono supportati di default.

Tuttavia, per alcuni sensori è possibile effettuare una calibrazione attraverso una procedura guidata (vedere i capitoli successivi).

Ogni tipo di sensore può essere sempre calibrato tramite il Veratron Configuration Tool per PC (vedere "Calibrazione dei sensori con Veratron Configuration Tool").

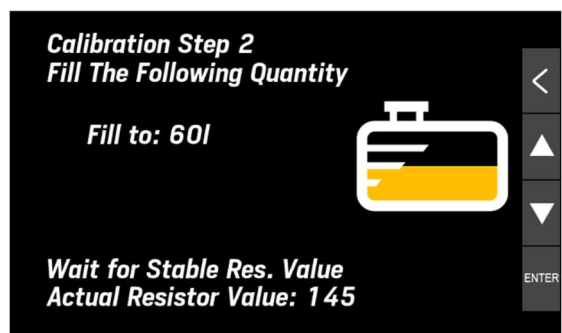

## CALIBRAZIONE DEL SENSORE DI LIVELLO CARBURANTE

1. Nel menu di configurazione descritto in precedenza, selezionare "Calibration" per aprire le opzioni di calibrazione del sensore.
2. Selezionare **Tank volume** per impostare la capacità del serbatoio (non obbligatorio).
3. Selezionare **Sensor type** per selezionare il una calibrazione standard tra quelle proposte.
4. Selezionare **Calibraton** per la procedura di calibrazione a uno o tre punti (**Do 1 point cal/Do 3-point cal**).  
Vengono visualizzate le istruzioni di calibrazione e il valore ohmico letto in tempo reale dal sensore [A].
5. Svuotare il serbatoio e attendere che il valore letto si stabilizzi. Confermare premendo [ENTER].
6. Per la calibrazione a tre punti, seguire le istruzioni a schermo.
7. Per tornare alle pagine dati premere [<].

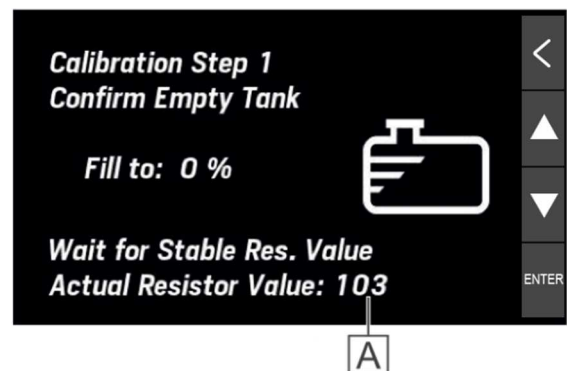
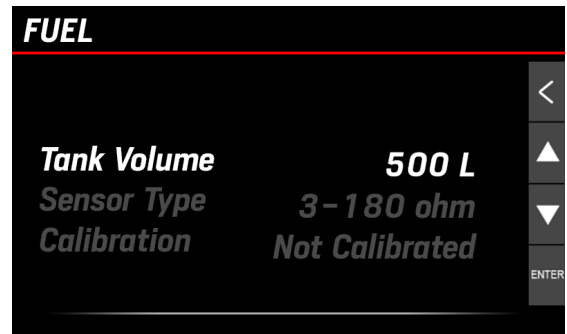

## CALIBRAZIONE DI ALTRI SENSORI (TRIM / ANGOLO DI BARRA)

1. Nel menu di configurazione degli ingressi descritto in precedenza, selezionare **Calibration** per aprire le opzioni di calibrazione del sensore.
2. Selezionare quindi la procedura di calibrazione a tre punti accedendo a **Do 3-point cal**.  
Vengono visualizzate le istruzioni di calibrazione e il valore ohmico letto in tempo reale dal sensore.
3. Per i sensori di acqua dolce o scura, i serbatoi devono essere svuotati, quindi attendere che il valore letto si stabilizzi. Confermare la lettura premendo [ENTER].
4. Procedere con tutti i punti di calibrazione seguendo la procedura guidata.
5. Tornare alle pagine dei dati premendo [<].

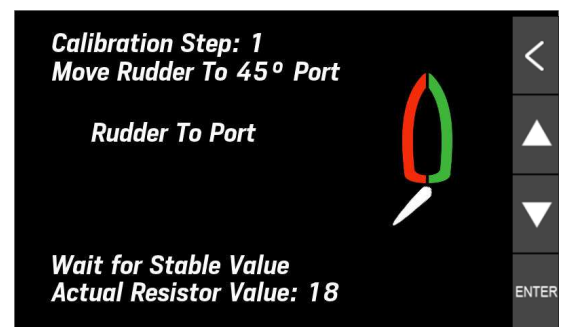
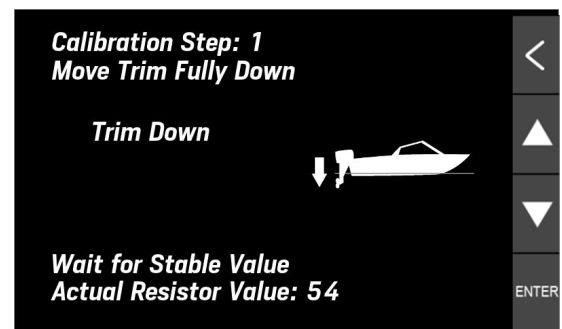

**CONFIGURAZIONE DEI SENSORI  
TRAMITE CONFIGURATION TOOL**

Nella parte inferiore del pannello Configurazione sensore, è possibile personalizzare completamente la configurazione di ogni porta analogica del display VMH.

*NOTA: questa operazione richiede comunque l'esecuzione di alcune impostazioni sul display stesso (impostare l'ingresso su "Personalizzato" e selezionare l'istanza di dati).*

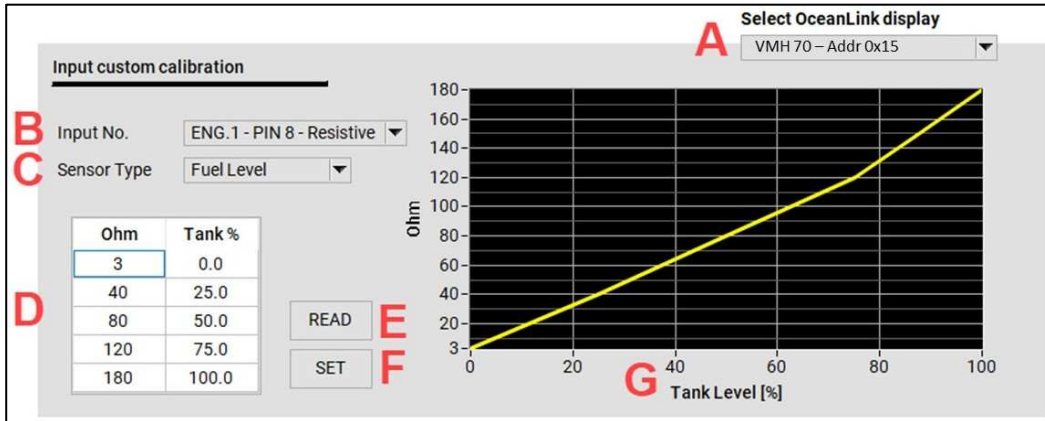

- 1** **Selezionare il display** da programmare dall'elenco a discesa [A].  
Se nella rete sono presenti più display VMH, tutti saranno visibili in questo elenco.

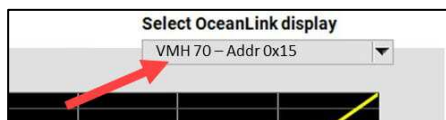

- 2** **NEL MENU DEL DISPLAY impostare la configurazione dei pin su "CUSTOM".**  
*Sensor Config → Scegliere la porta da configurare → Input → Custom*

Questa impostazione è necessaria sul display per consentire la sovrascrittura della configurazione locale dei pin.  
Quando si seleziona CUSTOM, la configurazione deve provenire da PC.

- 3** Tornando al PC, **selezionare l'ingresso da configurare [B].**  
Questa selezione deve corrispondere al pin configurato come CUSTOM sul display nel passaggio precedente.

- 4** **Selezionare il tipo di sensore** dall'elenco a discesa [C].

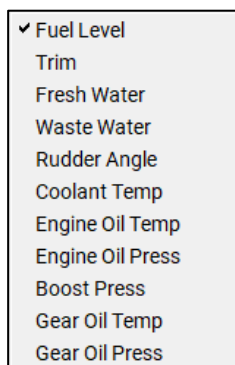

- 5** **Impostare manualmente la calibrazione a 5 punti** nella tabella [D] per il sensore selezionato.  
Il grafico [G] visualizzerà la calibrazione impostata.

| Ohm | Tank % |
|-----|--------|
| 3   | 0.0    |
| 45  | 25.0   |
| 90  | 50.0   |
| 135 | 75.0   |
| 180 | 100.0  |

*L'esempio sopra riportato si riferisce a un sensore di livello carburante standard da 3-180 Ω.*

- 6** **Caricare la configurazione** sul display.  
Premere il pulsante SET [F] per scrivere la configurazione per l'ingresso specifico.  
Verrà visualizzato un pop-up come conferma di sicurezza.
- Premere il pulsante READ [E] per leggere sul display la configurazione del pin definita in [A].

## CALIBRAZIONI PREDEFINITE

| Tipo di sensore                              | Calibrazione                 |
|--|------------------------------|
| Carburante                                   | 240-33 Ω                     |
|  | 3-180 Ω                      |
|  | 2-90 Ω                       |
| Acqua dolce                                  | 3-180 Ω (ingressi resistivi) |
|  | 4-20mA (ingressi capacitivi) |
| Acque scure                                  | 3-180 Ω (ingressi resistivi) |
|  | 4-20mA (ingressi capacitivi) |
| Trim   | 10-167 Ω                     |
| Angolo di barra                              | 10-180 Ω                     |
| Temperatura liquido di raffreddamento motore | 291-22 Ω                     |
| Temperatura olio motore                      | 197-11 Ω                     |
| Pressione olio motore                        | 10-184 Ω                     |
| Pressione di sovralimentazione               | 10-184 Ω                     |



### **REGOLAZIONE DEL FATTORE DI CORREZIONE DELLA VELOCITÀ**

Il fattore di correzione della velocità consente di allineare la velocità attraverso sull'acqua (STW) alla velocità reale.

Se la velocità misurata differisce dalla velocità reale dell'imbarcazione per più di 0,5 kn, è possibile regolare questo fattore.

L'aumento del fattore di offset riduce la velocità sull'acqua (STW) visualizzata.

# ALLARMI

Il display del VMH può visualizzare gli allarmi attivi provenienti da NMEA 2000, SAE J1939 o dai sensori analogici direttamente collegati. Gli allarmi del motore riguardano tutti i motori della rete.



## STRUTTURA DEL MENU

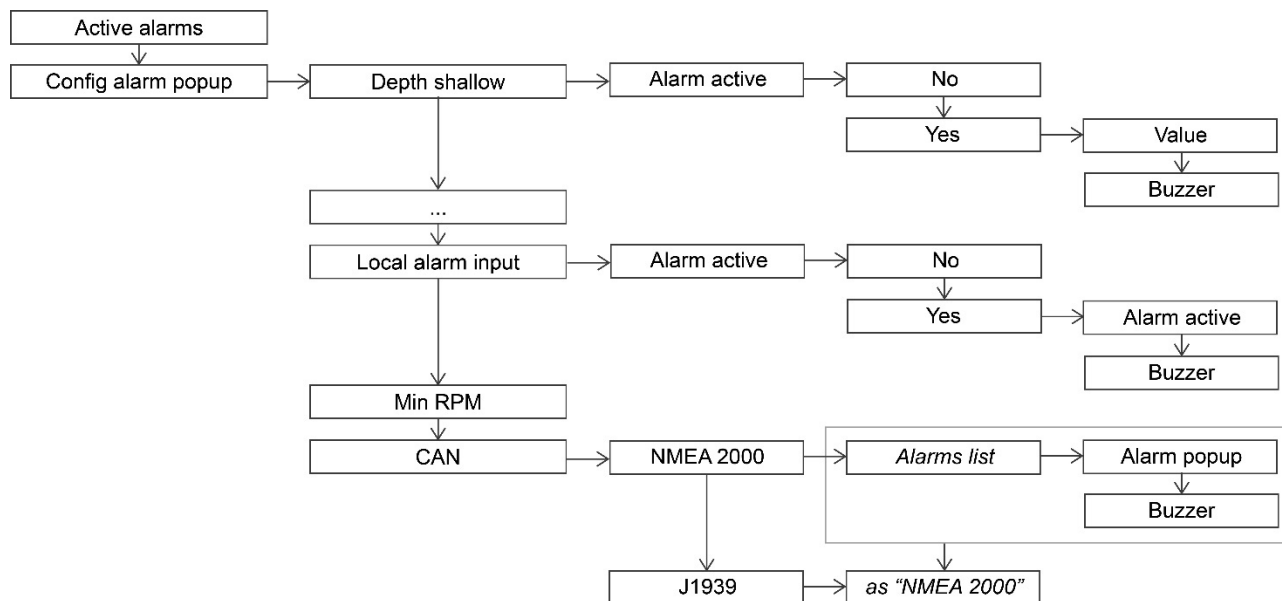

## NOTIFICA DEGLI ALLARMI

In caso di allarme:

- Viene visualizzato il pop-up dell'allarme
- L'uscita di allarme viene attivata, se collegata e configurata in tal senso.
- L'allarme attivo, comprese le informazioni aggiuntive, è visibile nella schermata Allarmi attivi.
- Se supportato, l'allarme locale viene trasmesso alla rete NMEA 2000.



## **RICONOSCERE UN ALLARME**

Quando si attiva un allarme, viene visualizzato il relativo pop-up di notifica e l'allarme esterno viene attivato (se collegato e configurato).

Per confermare l'allarme, toccare il touchscreen in qualsiasi punto: la notifica a comparsa viene chiusa e l'allarme viene salvato nella schermata "Active alarms".

L'allarme rimane visualizzato nella schermata "Active alarms" finché rimane attivo e un'icona di avviso viene visualizzata nella parte inferiore di ogni schermata per ricordare che un allarme è attualmente in corso.

## **ALLARMI ATTIVI**

Se è attivo almeno un allarme, dopo l'ultima schermata appare la schermata "Active alarms". È possibile accedere alla stessa schermata tramite [ALARMS] > [Active alarms].

Qui sono elencati tutti gli allarmi attualmente attivi, insieme ad alcuni simboli di avvertimento.

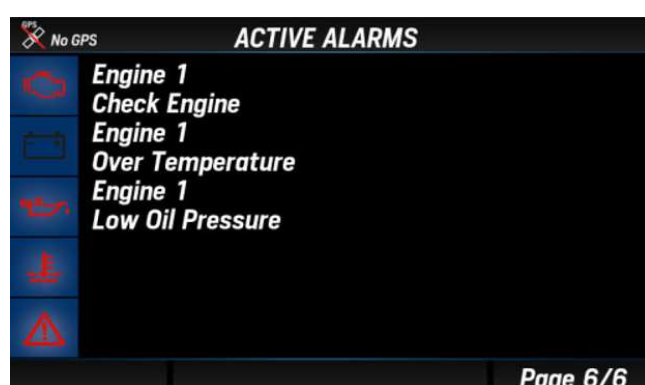

| <b>Simbolo</b>  | <b>Descrizione</b>         |
|---|----------------------------|
|  | Allarmi motore             |
|  | Allarmi batteria           |
|  | Allarmi olio               |
|  | Allarme temperatura motore |
|  | Allarme generico           |

## CONFIGURAZIONE DI UN ALLARME LOCALE

1. Premere il tasto MENU e selezionare [Alarms] > [Setup].
2. Selezionare uno degli allarmi supportati
3. Attivarlo selezionando [Active] > [Yes], ed appariranno i parametri dell'allarme.
4. Quindi selezionare e modificare le soglie e attivare/disattivare l'uscita di allarme.

| Impostazione        | Descrizione   | Valori possibili                   | Uscita NMEA 2000 |
|---------------------|---|------------------------------------|------------------|
| Depth shallow       | Allarme acqua bassa.  | 0 - 9,9 m (2m)                     | No               |
| Depth navigation    | Allarmi di navigazione in profondità.<br>Allarme acque profonde (ad esempio, un valore vicino al valore massimo misurabile dal sensore) o soglia minima di profondità di sicurezza.   | 0 - 99,9 m<br>(50m, 5m)            | No               |
| Wind                | Velocità del vento elevata.   | 0 - 99,9 km/h<br>(39,9km/h)        | No               |
| Battery voltage     | Tensione della batteria bassa.  | 0 - 32,9 V (10,8V)                 | Sì               |
| Battery Temperature | Temperatura elevata della batteria.   | 0 - 99 °C (50°C)                   | No               |
| Battery Charge      | Stato di carica della batteria bassa.   | 0 - 99 % (50%)                     | No               |
| Engine water temp   | Temperatura elevata del liquido di raffreddamento del motore.   | 0 - 139 °C (110°C)                 | Sì               |
| Engine oil temp     | Temperatura elevata dell'olio motore.   | 0 - 149 °C (120°C)                 | Sì               |
| Engine oil pressure | Bassa pressione dell'olio motore.   | 0 - 9,9 bar (0,5 bar)              | Sì               |
| Exhaust Gas Temp    | Elevata temperature dei gas di scarico.   | 0 - 899 °C<br>(500°C)              | Sì               |
| Fuel                | Livello di carburante basso.  | 0 - 99 % (20%)                     | No               |
| Fresh water         | Basso livello di acqua dolce.   | 0 - 99 % (20%)                     | No               |
| Waste water         | Livello elevato delle acque scure.  | 0 - 99 % (80%)                     | No               |
| Local alarm input   | Interruttore digitale esterno (allarme attivo basso).<br>Fare riferimento al "Diagramma dei collegamenti".<br><br>Il nome dell'allarme attivato può essere configurato tramite Veratron Configuration Tool.<br>Per ulteriori informazioni, rivolgersi al proprio rivenditore. | -                                  | No               |
| Min RPM             | Gli allarmi relativi al motore si attivano solo quando il regime del motore supera questa soglia.   | 0 - 990 GIRI/MIN<br>(300 GIRI/MIN) | -                |

**CONFIGURAZIONE DI UN ALLARME CAN**

1. Premere il tasto MENU e selezionare [ALARMS] > [Setup].
2. Selezionare [CAN] e quindi [NMEA 2000] o [SAE J1939].
3. Scegliere l'allarme da attivare e selezionare [Active] > [Yes]; appariranno i parametri dell'allarme
4. Se necessario, attivare/disattivare l'uscita di allarme.

| <b>Allarmi NMEA 2000</b><br>Motore (PGN 127489)  | <b>Allarmi NMEA 2000</b><br>Trasmissione (PGN 127493)   | <b>Allarmi SAE J1939</b><br>(DM1)  |
|--|---|--|
| <ul style="list-style-type: none"> <li>Controllare il motore</li> <li>Sovratemperatura</li> <li>Bassa pressione dell'olio</li> <li>Livello dell'olio basso</li> <li>Bassa pressione del carburante</li> <li>Bassa tensione di sistema</li> <li>Livello basso del refrigerante</li> <li>Flusso d'acqua</li> <li>Acqua nel carburante</li> <li>Indicatore di carica</li> <li>Indicatore di preriscaldamento</li> <li>Alta pressione di sovralimentazione</li> <li>Limite di giri superato</li> <li>Sistema EGR</li> <li>Sensore di posizione dell'acceleratore</li> <li>Arresto di emergenza del motore</li> <li>Livello di avviso 1</li> <li>Livello di avviso 2</li> <li>Riduzione della potenza</li> <li>Manutenzione necessaria</li> <li>Errore di Eng com</li> <li>Acceleratore secondario o secondario</li> <li>Protezione avvio neutro</li> <li>Spegnimento del motore</li> </ul> | <ul style="list-style-type: none"> <li>Controllare la trasmissione</li> <li>Sovratemperatura di trasmissione</li> <li>Transm. bassa pressione dell'olio</li> <li>Transm. livello olio basso</li> <li>Trasmissione Sail drive</li> </ul> | <ul style="list-style-type: none"> <li>Velocità del motore</li> <li>Pressione di sovralimentazione</li> <li>Temperatura dei gas di scarico</li> <li>Temperatura dell'olio motore</li> <li>Pressione del liquido di raffreddamento del motore</li> <li>Temperatura del liquido di raffreddamento del motore</li> <li>Temperatura dell'olio motore</li> <li>Pressa per olio di trasmissione</li> <li>Temperatura dell'olio della trasmissione</li> <li>Livello del carburante</li> <li>Acqua nel carburante</li> </ul> |

# RISOLUZIONE DEI PROBLEMI

| Problema   | Causa principale  | Soluzione   |
|--|---|---|
| I valori visualizzati non sono quelli previsti.  | Configurazione errata del sensore.  | Controllare la configurazione nel menu Sensori.   |
|  | Il sensore è stato collegato in modo errato.  | Controllare il collegamento, facendo riferimento alle Istruzioni per l'installazione.                     |
|  | La dorsale di rete NMEA 2000 non è stata creata correttamente.                                | Verificare i collegamenti e che sia presente una terminazione sia all'inizio che alla fine della dorsale. |
| Per un determinato dato viene visualizzato "--" o il puntatore lampeggia nel layout del NavDash. | I dati non sono disponibili in rete.  | Verificare che il dispositivo che invia queste informazioni funzioni correttamente.                       |
|  | Il sensore non è collegato.   | Collegare il sensore, facendo riferimento alle Istruzioni per l'installazione.                            |
|  | La dorsale di rete NMEA 2000 non è stata creata correttamente.                                | Verificare i collegamenti e che sia presente una terminazione sia all'inizio che alla fine della dorsale. |
| Gli stessi dati vengono visualizzati con due diversi valori alternati.                           | Configurazione errata del sensore.<br>Due fonti diverse inviano gli stessi dati su NMEA 2000. | Controllare gli ID motore/serbatoio (Show value as) nella configurazione del sensore.                     |

# DATI TECNICI

## CARATTERISTICHE GENERALI

|  |   |
|--|---|
| <b>Materiale</b>                               | Scocca in alluminio<br>Coperchio posteriore PC-FR<br>Schermo frontale in vetro minerale   |
| <b>Display</b>                                 | IPS TFT 7" - 800x480 - Touch screen trasmissivo<br>24 bit / 16 milioni di colori  |
| <b>Connettori</b>                              | <ul style="list-style-type: none"> <li>• 2x Molex MX150 12 pin</li> <li>• 1x NMEA 2000 Micro-C M12 5 pin</li> <li>• 2x AMP SuperSeal Serie 1.5 (EasyLink)</li> <li>• 1x M12 4 pin codifica "D" (Video)</li> </ul>   |
| <b>Dati di ingresso</b>                        | <ul style="list-style-type: none"> <li>• CAN (NMEA 2000 e SAE J1939)</li> <li>• 6x ingressi resistivi (0-400 <math>\Omega</math>)</li> <li>• 2x ingressi capacitivi (4-20mA)</li> <li>• 2 ingressi di frequenza (0-4 kHz)</li> <li>• 3 ingressi di tensione (0-5V)</li> <li>• 1x ingresso allarme digitale</li> </ul> |
| <b>Dati di uscita</b>                          | <ul style="list-style-type: none"> <li>• NMEA 2000</li> <li>• 2x EasyLink</li> <li>• 2x uscite di allarme (500mA max)</li> </ul>  |
| <b>Grado di protezione (secondo IEC 60529)</b> | IPX7  |

## CARATTERISTICHE AMBIENTALI

|                                  |                 |
|----------------------------------|-----------------|
| <b>Temperatura di esercizio</b>  | Da -25 a +70 °C |
| <b>Temperatura di stoccaggio</b> | Da -40 a +85 °C |

## CARATTERISTICHE ELETTRICHE

|                              |  |
|------------------------------|--|
| <b>Tensione nominale</b>     | 12/24 V  |
| <b>Tensione di esercizio</b> | 9-32 V   |
| <b>Consumo di corrente</b>   | < 900 mA @ 12 V (solo display)<br>100mA per ogni indicatore satellitare EasyLink |
| <b>Assorbimento (LEN)</b>    | 2  |

**CONFORMITÀ**

|                                |  |
|--------------------------------|--|
| <b>Conformità</b>              | CE, UKCA, Reach, RoHS, UL94  |
| <b>Direttive</b>               | 2014/30/UE (compatibilità elettromagnetica)<br>2011/65/UE (Sostanze pericolose nelle apparecchiature elettriche ed elettroniche) |
| <b>Standard di riferimento</b> | IEC 60945: 2002-08 (classe ambientale: esposto)  |

**MESSAGGI NMEA 2000 SUPPORTATI**

| <b>Descrizione</b>                          | <b>PGN</b> | <b>Descrizione</b>                      | <b>PGN</b>         |
|---|------------|---|--------------------|
| J1939 Generator Average Basic AC Quantities | 65030      | Water depth                             | 128267             |
| J1939 Diagnostic Message #1                 | 65226      | Position: Rapid update                  | 129025             |
| J1939 Diagnostic Message #2                 | 65227      | COG and SOG: Rapid update               | 129026             |
| J1939 Diagnostic Message #3                 | 65228      | GNSS position data                      | 129029             |
| J1939 Diagnostic Message #4                 | 65229      | Local Time Offset                       | 129033             |
| J1939 Diagnostic Message #5                 | 65230      | Datum                                   | 129044             |
| J1939 Diagnostic Message #6                 | 65231      | Cross track error                       | 129283             |
| J1939 Diagnostic Message #8                 | 65232      | Navigation data                         | 129284             |
| J1939 Diagnostic Message #10                | 65234      | Navigation route and waypoint info      | 129285             |
| J1939 Diagnostic Message #11                | 65235      | GNSS dilution of precision (DOP)        | 129539             |
| J1939 Diagnostic Message #12                | 65236      | GNSS satellites in view                 | 129540             |
| System time                                 | 126992     | Wind data                               | 130306             |
| Rudder                                      | 127245     | Environmental parameters                | 130310             |
| Vessel heading                              | 127250     | Environmental parameters                | 130311             |
| Rate of Turn                                | 127251     | Temperature                             | 130316<br>(130312) |
| Attitude                                    | 127257     | Humidity                                | 130313             |
| Temperature (Old Version)                   | 127258     | Actual Pressure                         | 130314             |
| Engine Parameters, Rapid Update             | 127488     | Entertainment - Current File and Status | 130569             |
| Engine Parameters, Dynamic                  | 127489     | Entertainment - Data File               | 130570             |
| Transmission Parameters, Dynamic            | 127493     | Entertainment - Data Group              | 130571             |
| Engine Parameters, Static                   | 127498     | Entertainment - Data Search             | 130572             |
| Fluid level                                 | 127505     | Entertainment - Supported Source Data   | 130573             |
| DC Detailed Status                          | 127506     | Entertainment - Supported Zone Data     | 130574             |
| Battery status                              | 127508     | Small Craft Status                      | 130576             |
| Speed: Water referenced                     | 128259     |   |                    |

**RESPONSABILITÀ DELLO SMALTIMENTO**



Smaltire con la raccolta differenziata attraverso i centri di raccolta designati dal governo o dagli enti locali.  
Lo smaltimento e il riciclaggio corretti aiutano a prevenire conseguenze potenzialmente negative per l'ambiente e le persone.



# RICAMBI E ACCESSORI

## RICAMBI

| Prodotto                                | Articolo      |
|---|---------------|
| Cavo di alimentazione e dati - Motore 1 | A2C1507870001 |
| Cavo dati - Motore 2                    | A2C1992110001 |
| Cavo di prolunga EasyLink               | A2C59500139   |
| Cavo di ingresso video 0,3 m            | A2C1845710001 |
| Sun cover                               | B00134401     |
| Kit di montaggio                        | B00067201     |

## ACCESSORI

| Prodotto                              | Articolo      |
|---------------------------------------|---------------|
| Satellite EasyLink VMH 14             | B00109901     |
| Cavo di alimentazione NMEA 2000       | A2C3931290001 |
| T-splitter NMEA 2000                  | A2C3931270002 |
| Cavo di derivazione NMEA 2000 - 0,5 m | A2C9624370001 |
| Cavo di derivazione NMEA 2000 - 2 m   | A2C9624380001 |
| Cavo di derivazione NMEA 2000 - 6 m   | A2C9624400001 |
| Terminatore NMEA 2000 - Maschio       | A2C3931100001 |
| Terminatore NMEA 2000 - Femmina       | A2C3931060001 |

Per tutti gli accessori disponibili, visitare il sito [www.veratron.com](http://www.veratron.com).



**veratron AG**  
Industriestrasse 18  
9464 Rütli, Svizzera

T +41 71 7679 111  
info@veratron.com  
veratron.com

---

È severamente vietata la distribuzione, la traduzione o la riproduzione, totale o parziale, del presente documento senza il previo consenso scritto di veratron AG, ad eccezione di quanto indicato di seguito:

- Stampare il documento nel suo formato originale, in tutto o in parte.
- Copia dei contenuti senza modifiche e dichiarazione di Veratron AG come proprietario del copyright.

Veratron AG si riserva il diritto di apportare modifiche o miglioramenti alla presente documentazione senza preavviso.

Richieste di autorizzazione, copie aggiuntive di questo manuale o informazioni tecniche su questo manuale devono essere indirizzate a veratron AG.